

Advanced User's Guide

MFC-J2310
MFC-J4410DW
MFC-J4610DW
DCP-J4110DW

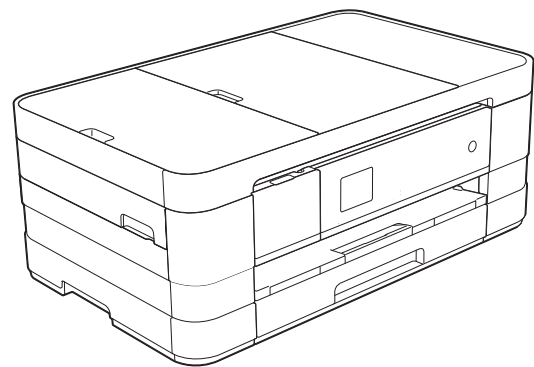

User's Guides and where do I find them?

Which Guide?	What's in it?	Where is it?
Product Safety Guide	Read this Guide first. Read the Safety Instructions before you set up your machine. See this Guide for trademarks and legal limitations.	Printed / In the box
Quick Setup Guide	Follow the instructions for setting up your machine, installing the drivers and software for the operating system and connection type you are using.	Printed / In the box
Basic User's Guide	Learn the basic Fax, Copy, Scan and PhotoCapture Center™ operations and how to replace consumables. See troubleshooting tips.	Printed / In the box
Advanced User's Guide	Learn more advanced operations: Fax, Copy, security features, printing reports and performing routine maintenance.	PDF file / CD-ROM
Software User's Guide	Follow these instructions for Printing, Scanning, Network Scanning, PhotoCapture Center™, Remote Setup, PC-Fax, Web Services (Scan), and using the Brother ControlCenter utility.	PDF file / CD-ROM
Network User's Guide	This Guide provides useful information about wired and wireless network settings and security settings using the Brother machine. You can also find supported protocol information for your machine and detailed troubleshooting tips.	PDF file / CD-ROM
Web Connect Guide	This Guide provides useful information about accessing Internet services from the Brother machine, as well as downloading images, printing data and uploading files directly to Internet services.	PDF file / Brother Solutions Center ¹
AirPrint Guide	This Guide provides information for using AirPrint to print from Mac OS X v10.7.x and your iPhone, iPod touch, iPad, or other iOS device to your Brother machine without installing a printer driver.	PDF file / Brother Solutions Center ¹
Google Cloud Print Guide	This Guide provides information about how to use Google Cloud Print™ services for printing over the Internet.	PDF file / Brother Solutions Center ¹
Wi-Fi Direct™ Guide	This Guide provides information about how to configure and use your Brother machine for wireless printing directly from a mobile device supporting the Wi-Fi Direct™ standard.	PDF file / Brother Solutions Center ¹
Mobile Print/Scan Guide for Brother iPrint&Scan	This Guide provides useful information about printing from your mobile device and scanning from your Brother machine to your mobile device when connected to a Wi-Fi network.	PDF file / Brother Solutions Center ¹

¹ Visit us at <http://solutions.brother.com/>.

Table of Contents

1	General setup	1
	IMPORTANT NOTE.....	1
	Memory Storage	1
	Setting Daylight Saving Time (MFC models).....	1
	Sleep Mode	2
	Auto Power Off (DCP-J4110DW)	2
	Touchscreen LCD.....	3
	Changing the Touchscreen language (depending on your model).....	3
	Setting the Dim Timer for the backlight	3
	Dial Prefix	3
	Setting up or changing the prefix number.....	3
2	Security features	4
	Secure Function Lock 2.0.....	4
	Before you begin to use Secure Function Lock 2.0.....	4
	Setting and changing the Administrator Password.....	5
	Setting up restricted users.....	6
	Turning Secure Function Lock on/off.....	7
	Switching users	7
	Changing to the Public mode	7
3	Sending a fax (MFC models only)	8
	Additional sending options.....	8
	Sending faxes using multiple settings	8
	Stop faxing.....	8
	Contrast	8
	Changing fax resolution.....	9
	Setting your changes as a new default.....	10
	Restoring fax options to the factory default	10
	Additional sending operations.....	11
	Sending a fax manually	11
	Sending a fax at the end of a conversation	11
	Dual Access (Monochrome only).....	11
	Broadcasting (Monochrome only).....	12
	Real Time Transmission.....	13
	Overseas Mode	14
	Delayed Faxing (Monochrome only).....	14
	Delayed Batch Transmission (Monochrome only).....	15
	Checking and cancelling waiting jobs.....	15
	Polling overview.....	16
	Polled Transmit (Monochrome only).....	16

4 Receiving a fax (MFC models only) 17

Memory Receive (Monochrome only).....	17
Fax Forwarding.....	17
Fax Storage.....	18
Printing a fax from the memory.....	18
PC-Fax Receive (Windows® only).....	19
Turning off Memory Receive operations.....	20
Changing Memory Receive operations.....	20
Remote Retrieval.....	21
Setting a Remote Access Code.....	21
Using your Remote Access Code.....	21
Remote Fax commands.....	22
Retrieving fax messages.....	23
Changing your Fax Forwarding number.....	23
Additional receiving operations.....	24
Out of Paper Reception.....	24
Printing a reduced incoming fax.....	24
Receiving a fax at the end of a conversation.....	24
Temporary Fax Backup.....	25
Polling overview.....	26
Polling receive.....	26

5 Dialling and storing numbers (MFC models only) 28

Additional dialling operations.....	28
Combining Speed Dial numbers.....	28
Additional ways to store numbers.....	29
Storing Speed Dial numbers from Outgoing Calls.....	29
Storing Speed Dial numbers from the Caller ID history.....	30
Setting up Groups for Broadcasting.....	31

6 Printing reports 33

Fax reports (MFC models only).....	33
Transmission Verification Report.....	33
Fax Journal (activity report).....	33
Reports.....	34
How to print a report.....	34

7 Making copies 35

Copy options.....	35
Stop copying.....	35
Changing copy speed and quality	35
Enlarging or reducing the copied image	36
Making N in 1 copies or a poster (Page Layout)	37
2 in 1 ID Copy (Page Layout)	38
Sorting copies.....	39
Adjusting Density.....	40
Ink Save Mode.....	40
Thin Paper Copy.....	41
Book Copy	41
Remove Background Colour	42
2-sided copying	42
Setting your changes as a new default.....	44
Restoring all settings to the factory default.....	44

8 Printing photos from a memory card or USB Flash memory drive 45

PhotoCapture Center™ operations	45
Memory cards, USB Flash memory drive and folder structures	45
Movie printing	46
Print Images.....	46
Print Index (Thumbnails)	46
Printing Photos	47
Printing All Photos	47
DPOF printing.....	48
PhotoCapture Center™ print settings.....	48
Print Quality	48
Paper options	49
Adjusting Brightness, Contrast and Colour.....	50
Cropping	52
Borderless printing.....	52
Date Print.....	53
Setting your changes as a new default.....	53
Restoring all settings to the factory default.....	54
Scan to a memory card or USB Flash memory drive	54
How to set a new default	54
How to reset to the factory default.....	55

9 Printing photos from a camera 56

Printing photos directly from a PictBridge camera.....	56
PictBridge requirements	56
Setting your digital camera	56
Printing Images.....	57
DPOF printing.....	58
Printing photos directly from a digital camera (without PictBridge).....	58
Printing Images.....	59

A	Routine maintenance	60
	Cleaning and checking the machine	60
	Cleaning the outside of the machine	60
	Cleaning the machine's printer platen	61
	Cleaning the paper feed rollers	62
	Cleaning the paper pick-up rollers	63
	Cleaning the paper pick-up rollers for paper tray #2 (MFC-J4610DW)	64
	Checking the ink volume	64
	Packing and shipping the machine	65
B	Glossary	67
C	Index	71

IMPORTANT NOTE

- Most of the illustrations in this User's Guide show the MFC-J4410DW.

Memory Storage

(MFC-J2310, MFC-J4410DW and MFC-J4610DW)



Your menu settings are stored permanently and in the event of a power failure, will not be lost. Temporary settings (for example, `Overseas Mode`) will be lost. If you have chosen `Set New Default` for your preferred `Fax`, `Scan`, `Copy` and `Photo` settings, those settings will not be lost. Also, during a power failure, the machine will retain the date and time and programmed fax timer jobs (for example, `Delayed Fax`) for up to 24 hours.

(DCP-J4110DW)

Your menu settings are stored permanently, and in the event of a power failure will not be lost. If you have chosen `Set New Default`, settings in the `Copy`, `Photo` and `Scan` modes will not be lost. Temporary settings will be lost.



Setting Daylight Saving Time (MFC models)

You can set the machine to change for daylight saving time. When selecting `Forward Hour` it will forward the time by an hour and `backward one hour` when selecting `Backward Hour`. Make sure you have set the correct date and time in the `Date & Time` setting.

- 1 Press  (Settings).
- 2 Press `^` or `v` on the Touchpanel to display `Initial Setup`.
- 3 Press `Initial Setup`.
- 4 Press `Date & Time`.
- 5 Press `^` or `v` to display `Daylight Save`.
- 6 Press `Daylight Save`.
- 7 Press `Forward Hour` or `Backward Hour`.
- 8 Press .

Sleep Mode

You can choose how long the machine will remain idle before it goes into Sleep Mode (up to 60 minutes). The timer will restart if any operation is carried out on the machine.



- 1 Press  (Settings).
- 2 Press **^** or **v** on the Touchpanel to display `General Setup`.
- 3 Press `General Setup`.
- 4 Press **^** or **v** to display `Sleep Mode`.
- 5 Press `Sleep Mode`.
- 6 Press **^** or **v** to display `1Min`, `2Mins`, `3Mins`, `5Mins`, `10Mins`, `30Mins` or `60Mins` to choose the length of time the machine must be idle before entering Sleep Mode. Press the option you want to set.
- 7 Press .

Auto Power Off (DCP-J4110DW)

The Auto Power Down feature will turn the machine off one hour after entering Sleep Mode. When this feature is `Off`, the machine will not power off automatically.

Note that the machine will not power off automatically when:



- the machine is connected to a wired network
- the machine is connected to a wireless network
- WLAN is selected in the `Network I/F` setting

- 1 Press  (Settings).
- 2 Press **^** or **v** on the Touchpanel to display `General Setup`.
- 3 Press `General Setup`.
- 4 Press **^** or **v** to display `Auto Power Off`.
- 5 Press `Auto Power Off`.
- 6 Press `On` (or `Off`).
- 7 Press .

Touchscreen LCD



Changing the Touchscreen language (depending on your model)

You can change the Touchscreen language.

- 1 Press  (Settings).
- 2 Press **▲** or **▼** to display Initial Setup.
- 3 Press Initial Setup.
- 4 Press **▲** or **▼** to display Local Language.
- 5 Press Local Language.
- 6 Press your language.
- 7 Press .

Setting the Dim Timer for the backlight

You can set how long the LCD backlight stays on after the last finger press.

- 1 Press  (Settings).
- 2 Press **▲** or **▼** on the Touchpanel to display General Setup.
- 3 Press General Setup.
- 4 Press **▲** or **▼** to display LCD Settings.
- 5 Press LCD Settings.
- 6 Press Dim Timer.
- 7 Press **▲** or **▼** to display 10Secs, 20Secs, 30Secs or Off, and then press the option you want to set.
- 8 Press .

Dial Prefix

The Dial Prefix setting will dial a predefined number before every fax number you dial. For example, if your telephone system requires you to dial a 9 before an outside number, use this setting to dial 9 for every fax you send.

Setting up or changing the prefix number

- 1 Press  (Settings).
- 2 Press **▲** or **▼** on the Touchpanel to display Initial Setup.
- 3 Press Initial Setup.
- 4 Press **▲** or **▼** to display Dial Prefix.
- 5 Press Dial Prefix.
- 6 Press On (or Off).
- 7 Press Dial Prefix.
- 8 Enter the prefix number (up to 5 digits) using the keyboard on the Touchscreen.
- 9 Press OK.

NOTE

- If your telephone system requires a timed break recall (hookflash), press “!” on the Touchscreen.
- You cannot use “!” with any other numbers or characters.
- (Not available in New Zealand) If the pulse dialling mode is on, # and * are not available to use.

- 10 Press .

Secure Function Lock 2.0

Secure Function Lock lets you restrict public access to certain machine functions:

- Fax Tx (Fax Transmit) ¹
- Fax Rx (Fax Receive) ¹
- Copy
- Scan
- PCC (PhotoCapture Center™)
- PC Print
- Colour Print
- Page Limit
- Web Upload
- Web Download

¹ MFC models only.

This feature also prevents users from changing the machine's default settings by limiting access to its functions.

Before using the security features, you must first enter an administrator password.

Access to restricted operations can be enabled by creating a restricted user.

Restricted users must enter a password to use the machine.

Make a careful note of your password. If you forget it, contact Brother customer service for support.

NOTE

- Only administrators can set limitations and make changes for each user.
- If Fax Tx is disabled, you cannot use any functions in the Fax menu. ¹
- Polled Transmit and Polling Receive are enabled only when both Fax Tx and Fax Rx are enabled. ¹
- You cannot edit or delete a Shortcut when Secure Function Lock is set to On.

¹ MFC models only.

Before you begin to use Secure Function Lock 2.0

You can configure Secure Function Lock 2.0 settings using a Web browser. Before configuration, the following preparations are required.

- 1 Start your Web browser.
- 2 Type "http://machine's IP address/" into your browser's address bar (where "machine's IP address" is the IP address of the machine).

- For example:

`http://192.168.1.2/`

NOTE

You can find the machine's IP address in the Network Configuration List. (See Network User's Guide: *Printing the Network Configuration Report*.)

- 3 Enter a password in the **Login** box. (This is a password to log into the machine's Web page, not the administrator password for Secure Function Lock.) Click .

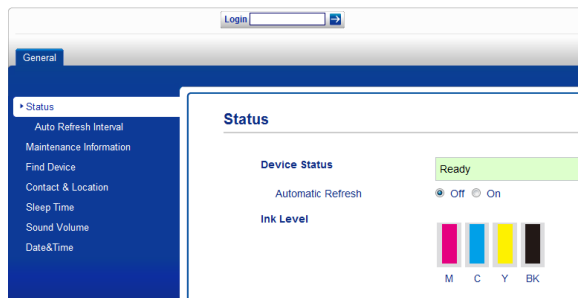

NOTE

If you are using a Web browser to configure the machine's settings for the first time, set a password.

- 1 Click **Please configure the password.**
- 2 Enter a password you want to use (up to 32 characters).
- 3 Re-enter the password in the **Confirm New Password** box.
- 4 Click **Submit.**

Setting and changing the Administrator Password

You can configure these settings using a Web browser. To set up the Web page, see *Before you begin to use Secure Function Lock 2.0* on page 4. Then follow the instructions below.

Setting the administrator password

The password you set in these steps is for the administrator. This password is used to set up users and to turn Secure Function Lock on or off. (See *Setting up restricted users* on page 6 and *Turning Secure Function Lock on/off* on page 7.)

- 1 Click **Administrator.**
- 2 Click **Secure Function Lock.**
- 3 Enter a four-digit number for the password in the **New Password** box.

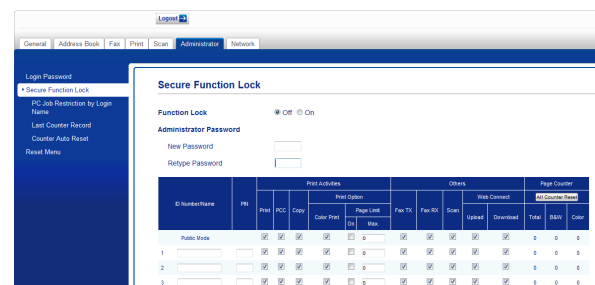

- 4 Re-enter the password in the **Retype Password** box.
- 5 Click **Submit.**

Changing the administrator password

- 1 Click **Administrator**.
- 2 Click **Secure Function Lock**.
- 3 Enter a four-digit number for the new password in the **New Password** box.
- 4 Re-enter the new password in the **Retype Password** box.
- 5 Click **Submit**.

Setting up restricted users

You can set up users with restrictions and a password. You can set up to 10 users.

You can configure these settings using a Web browser.

To set up the Web page, see *Before you begin to use Secure Function Lock 2.0* on page 4. Then follow the instructions below.

- 1 Click **Administrator**.
- 2 Click **Secure Function Lock**.
- 3 Enter an alphanumeric Group name or User name (up to 15 characters) in the **ID Number/Name** box and then enter a four-digit password in the **PIN** box.

ID Number/Name	Pin	Print Activities				Others				Page Counter		
		Print	PCL	Copy	Print Options	Page Limit	Fax TX	Fax RX	Scan	Web Connect	Total	Color
Public User		<input checked="" type="checkbox"/>	<input checked="" type="checkbox"/>	<input checked="" type="checkbox"/>	<input checked="" type="checkbox"/>	<input type="checkbox"/>	<input type="checkbox"/>	<input type="checkbox"/>	<input type="checkbox"/>	<input type="checkbox"/>	<input type="checkbox"/>	<input type="checkbox"/>
1		<input checked="" type="checkbox"/>	<input checked="" type="checkbox"/>	<input checked="" type="checkbox"/>	<input type="checkbox"/>	<input type="checkbox"/>	<input type="checkbox"/>	<input type="checkbox"/>	<input type="checkbox"/>	<input type="checkbox"/>	<input type="checkbox"/>	<input type="checkbox"/>
2		<input checked="" type="checkbox"/>	<input checked="" type="checkbox"/>	<input checked="" type="checkbox"/>	<input type="checkbox"/>	<input type="checkbox"/>	<input type="checkbox"/>	<input type="checkbox"/>	<input type="checkbox"/>	<input type="checkbox"/>	<input type="checkbox"/>	<input type="checkbox"/>
3		<input checked="" type="checkbox"/>	<input checked="" type="checkbox"/>	<input checked="" type="checkbox"/>	<input type="checkbox"/>	<input type="checkbox"/>	<input type="checkbox"/>	<input type="checkbox"/>	<input type="checkbox"/>	<input type="checkbox"/>	<input type="checkbox"/>	<input type="checkbox"/>

- 4 Uncheck the functions that you want to restrict in the **Print Activities** boxes and the **Others** boxes. If you want to configure the maximum page count, check the **On** box in **Page Limit**, and then enter the number in the **Max.** box. Click **Submit**.

NOTE





- You cannot use the same password as another user's password.
- You can set up one Public user. Public users do not need to enter a password. For more information, see *Network User's Guide*.

Turning Secure Function Lock on/off

NOTE

If you enter the wrong password, the Touchscreen will show Wrong Password. Enter the correct password. If you forget it, contact Brother customer service for support.

Turning Secure Function Lock on



- 1 Press  (Settings).
- 2 Press  or  on the Touchpanel to display General Setup.
- 3 Press General Setup.
- 4 Press  or  to display Function Lock.
- 5 Press Function Lock.
- 6 Press Lock Off→On.
- 7 Enter your four-digit administrator password using the keyboard on the Touchscreen.
Press OK.

NOTE

The Secure Function Lock icon is prominently displayed on the Home screen.







Turning Secure Function Lock off

- 1 Press  Public or  (where xxxxx is the user's name).
- 2 Press Lock On→Off.
- 3 Enter your four-digit administrator password using the keyboard on the Touchscreen.
Press OK.

Switching users

This setting allows a restricted user to log on to the machine when the Secure Function Lock is turned on.

- 1 On the Touchscreen, press  Public or  (where xxxxx is the user's name).
- 2 Press  or  on the Touchpanel to display Change User.
- 3 Press Change User.
- 4 Press  or  to display your user name.
- 5 Press your user name.
- 6 Enter your four-digit user password using the keyboard on the Touchscreen.
Press OK.

Changing to the Public mode

- 1 Press  (where xxxxx is the user's name).
- 2 Press Go to Public.

3

Sending a fax (MFC models only)

Additional sending options

Sending faxes using multiple settings

When you send a fax, you can choose a combination of settings, such as Fax Resolution, Contrast, Glass Scan Size, and Real Time TX.

You can also choose: History, Address Book, Broadcasting, Colour Setting, Delayed Fax, Batch TX, Polled TX, Polling RX, Overseas Mode, Set New Default, and Factory Reset.

Some settings are only available when sending mono faxes.

1 Load your document.

2 Press  (Fax).

The Touchscreen shows:



3 Press **Options**.

4 Press **^** or **v** on the Touchpanel to display the setting you want to change. Press the setting when it is displayed.

5 Press the option you want to set.

6 Go back to step 4 if you want to change any more settings.

7 Press **OK** when you have finished changing settings.

8 Enter the fax number.

9 Press **Fax Start**.

NOTE

- Most settings are temporary and the machine returns to its default settings after you send a fax.
- You can save some of the settings you use most often by setting them as the default settings. These settings will remain until you change them again. (See *Setting your changes as a new default* on page 10.)

Stop faxing

To stop faxing, press .

Contrast

If your document is very light or very dark, you may want to change the contrast. For most documents, the factory setting **Auto** can be used. It automatically chooses the suitable contrast for your document.

Choose **Light** when sending a light document. Choose **Dark** when sending a dark document.

1 Load your document.

2 Press  (Fax).

3 Press **Options**.

4 Press **^** or **v** on the Touchpanel to display **Contrast**.

5 Press **Contrast**.

- 6 Press **▲** or **▼** to display **Auto**, **Light** or **Dark**, and then press the option you want to set.
- 7 Press **OK**.
- 8 Enter the fax number.
- 9 Press **Fax Start**.

NOTE

Even if you choose **Light** or **Dark**, the machine will send the fax using the **Auto** setting in any of the following conditions:

- When you send a colour fax.
- When you choose **Photo** as the Fax Resolution.

Changing fax resolution

The quality of a fax can be improved by changing the fax resolution.

- 1 Load your document.
- 2 Press  (**Fax**).
- 3 Press **Options**.
- 4 Press **▲** or **▼** on the Touchpanel to display **Fax Resolution**.
- 5 Press **Fax Resolution**.
- 6 Press **▲** or **▼** to display the resolution options, and then press the option you want to set.
- 7 Press **OK**.
- 8 Enter the fax number.
- 9 Press **Fax Start**.

NOTE

You can choose four different resolution settings for monochrome faxes and two for colour.

Monochrome	
Standard	Suitable for most typed documents.
Fine	Good for small print and transmits a little slower than Standard resolution.
S.Fine	Good for small print or artwork and transmits slower than Fine resolution.
Photo	Use when the document has varying shades of grey or is a photograph. Photo has the slowest transmission.

Colour	
Standard	Suitable for most typed documents.
Fine	Use when the document is a photograph. The transmission time is slower than Standard resolution.

If you choose **S.Fine** or **Photo** and then send a colour fax (choosing **Colour** in **Colour Setting**), the machine will send the fax using the **Fine** setting.

Setting your changes as a new default

You can save the settings for the fax options you use most often by setting them as default settings, such as Fax Resolution, Contrast, Colour Setting, Real Time TX, and Glass Scan Size. These settings will remain until you change them again.



- 1 Press  (Fax).
- 2 Press Options.
- 3 Press **^** or **v** on the Touchpanel to choose the menu option that you want to change. Press your new option.

Repeat this step for each setting you want to change.

- 4 After changing the last setting to your preferred option, press **^** or **v** to display Set New Default.
- 5 Press Set New Default.
- 6 Press OK.
- 7 The Touchscreen asks you to confirm the change to the new default settings. Press Yes to confirm.
- 8 Press .

Restoring fax options to the factory default

You can restore all the fax options you have changed back to the factory default. These settings will remain until you change them again.

- 1 Press  (Fax).
- 2 Press Options.
- 3 Press **^** or **v** on the Touchpanel to display Factory Reset.
- 4 Press Factory Reset.
- 5 The Touchscreen asks you to confirm to change back to the factory default. Press Yes to confirm.
- 6 Press .

Additional sending operations

Sending a fax manually

Manual transmission lets you hear the dialling, ringing and fax-receiving tones while sending a fax.

NOTE

(MFC-J4410DW and MFC-J4610DW)

To send a multi-page fax, use the ADF.

- 1 Load your document.
- 2 Press  (Fax).
- 3 To listen for a dial tone, press `Hook`.
- 4 Dial the fax number.
- 5 When you hear the fax tones, press `Fax Start`.
If you are using the scanner glass, press `Send` on the Touchscreen to send the fax.

Sending a fax at the end of a conversation

At the end of a conversation, you can send a fax to the other party before you both hang up.

- 1 Ask the other party to wait for fax tones (beeps) and then to press the `Start` or `Send` key before hanging up.
- 2 Load your document.
- 3 Press `Fax Start`.
 - If you are using the scanner glass, press `Send` to send the fax.
- 4 Replace the handset of the external phone.

Dual Access (Monochrome only)

You can dial a number and start scanning the fax into memory—even when the machine is sending from memory, receiving faxes or printing PC data. The Touchscreen shows the new job number.

The number of pages you can scan into the memory will vary depending on the data that is printed on them.

NOTE

If the `Out of Memory` message appears, press  to cancel or `OK` to send the pages scanned so far.

Broadcasting (Monochrome only)

Broadcasting is when the same fax message is automatically sent to more than one fax number. You can include Groups and Speed Dial numbers in the same broadcast.



After the broadcast is finished, a Broadcast Report will be printed.

Before you begin the broadcast

Speed Dial numbers must be stored in the machine's memory before they can be used in a broadcast. (See Basic User's Guide: *Storing Speed Dial numbers.*)

Group numbers must also be stored in the machine's memory before they can be used in a broadcast. Group numbers include many stored Speed Dial numbers for easier dialling. (See *Setting up Groups for Broadcasting* on page 31.)

How to broadcast a fax

- 1 Load your document.
- 2 Press  (Fax).
- 3 Press **Options**.
- 4 Press **^** or **v** on the Touchpanel to display **Broadcasting**.
- 5 Press **Broadcasting**.
- 6 Press **Add from Address Book**.
Press  to search by **Alphabetical Order** or **Numerical Order**. Press the check boxes of the numbers you want to add to the broadcast. After you have checked all the numbers you want to add, press **OK**.

NOTE

If you have downloaded Internet Fax:

You can broadcast to an E-mail address if you stored it as a Speed Dial number. (See Basic User's Guide: *Storing Speed Dial numbers.*)

- 7 Press **^** or **v** to review and confirm the displayed list of numbers for the broadcast, and then press **OK** to accept it.
- 8 If you have finished changing settings, press **OK**.
- 9 Press **Fax Start**.

NOTE

Broadcasting is not available when you select **Colour** in **Colour Setting**.

Faxing from the ADF (MFC-J4410DW and MFC-J4610DW)

- The machine starts scanning the document.

Faxing from the scanner glass

When the Touchscreen asks you **Next Page?**, do one of the following:

- To send a single page, press **No (Send)**.
The machine starts sending the document.
- To send more than one page, press **Yes** and place the next page on the scanner glass.



Press **OK**.

The machine starts scanning the page. (Repeat this step for each additional page.)

NOTE

- If you did not use up any of the numbers for Groups, you can “broadcast” faxes to as many as 200 different numbers.
- The machine’s available memory will vary depending on the types of jobs in the memory and the number of locations used for broadcasting. If you broadcast to the maximum numbers available, you will not be able to use dual access and delayed fax.
- If the `Out of Memory` message appears, press  to cancel or `OK` to send the pages scanned so far.

Cancelling a Broadcast in progress

- 1 Press .
- 2 Do one of the following:
 - To cancel the entire broadcast, press `Entire Broadcast`. Go to step 3.
 - To cancel the current job, press the number being dialled on the Touchscreen. Go to step 4.
 - To exit without cancelling, press .
- 3 When the Touchscreen asks if you want to cancel the entire broadcast, do one of the following:
 - Press `Yes` to confirm.
 - To exit without cancelling, press `No`.
- 4 Do one of the following:
 - To cancel the current job, press `Yes`.
 - To exit without cancelling, press `No`.

Real Time Transmission

When you are sending a fax, the machine will scan the documents into the memory before sending. Then, as soon as the telephone line is free, the machine will start dialling and sending.

Sometimes, you may want to send an important document immediately, without waiting for memory transmission. You can do this by turning on `Real Time TX`.

- 1 Load your document.
- 2 Press  (`Fax`).
- 3 Press `Options`.
- 4 Press `▲` or `▼` on the Touchpanel to display `Real Time TX`.
- 5 Press `Real Time TX`.
- 6 Press `On (or Off)`.
- 7 Press `OK`.
- 8 Enter the fax number.
- 9 Press `Fax Start`.

NOTE

- If you are sending a colour fax or if the memory is full and you are sending a monochrome fax from the ADF¹, the machine will send the document in real time (even if `Real Time TX` is set to `Off`).
- ¹ MFC-J4410DW and MFC-J4610DW only.
- In Real Time Transmission, the automatic redial feature does not work when you are using the scanner glass.

Overseas Mode

If you are having difficulty sending a fax overseas due to possible interference on the telephone line, we recommend that you turn on Overseas Mode. After you send a fax using this feature, the feature will automatically turn itself off.

- 1 Load your document.
- 2 Press  (Fax).
- 3 Press `Options`.
- 4 Press `^` or `v` on the Touchpanel to display `Overseas Mode`.
- 5 Press `Overseas Mode`.
- 6 Press `On (or Off)`.
- 7 Press `OK`.
- 8 Enter the fax number.
- 9 Press `Fax Start`.

Delayed Faxing (Monochrome only)

You can store up to 50 faxes in the memory to be sent within the next 24 hours. These faxes will be sent at the time of day you enter in step 7.

- 1 Load your document.
- 2 Press  (Fax).
- 3 Press `Options`.
- 4 Press `^` or `v` on the Touchpanel to display `Delayed Fax`.
- 5 Press `Delayed Fax`.
- 6 Press `On (or Off)`.
- 7 Enter the time you want the fax to be sent (in 24-hour format) using the keyboard on the Touchscreen.
(For example, enter 19:45 for 7:45 PM.)
Press `OK`.

NOTE

The number of pages you can scan into the memory depends on the amount of data that is printed on each page.



- 8 Press `OK`.
- 9 Enter the fax number.
- 10 Press `Fax Start`.

NOTE

Delayed Fax is not available when you select `Colour` in `Colour Setting`.



Delayed Batch Transmission (Monochrome only)

Before sending the delayed faxes, your machine will help you economize by sorting all the faxes in the memory by destination and scheduled time. All delayed faxes that are scheduled to be sent at the same time to the same fax number will be sent as one fax to save transmission time.

- 1 Press  (Fax).
- 2 Press *Options*.
- 3 Press **▲** or **▼** on the Touchpanel to display *Batch TX*.
- 4 Press *Batch TX*.
- 5 Press *On* (or *Off*).
- 6 Press .

Checking and cancelling waiting jobs

You can check which jobs are still waiting in the memory to be sent, or cancel a job. (If there are no jobs, the Touchscreen shows *No Jobs Waiting*.)

- 1 Press  (*Settings*).
- 2 Press **▲** or **▼** on the Touchpanel to display *Fax*.
- 3 Press *Fax*.
- 4 Press **▲** or **▼** to display *Remaining Jobs*.
- 5 Press *Remaining Jobs*. Any waiting jobs appear on the Touchscreen.
- 6 Press **▲** or **▼** to scroll through the jobs and press the job you want to cancel. Press *Cancel*.
- 7 Do one of the following:
 - To cancel, press *Yes*.
If you want to cancel another job, go to step 6.
 - To exit without cancelling, press *No*.
- 8 When you have finished, press .

Polling overview

Polling lets you set up your machine so other people can receive faxes from you, but they pay for the call. It also lets you call somebody else's fax machine and receive a fax from it, so you pay for the call. The polling feature needs to be set up on both machines for this to work. Not all fax machines support polling.

Polled Transmit (Monochrome only)

Polled transmit lets you set up your machine to wait with a document so another fax machine can call and retrieve it.

The document will be stored and can be retrieved by any other fax machine until you delete it from the memory. (See *Checking and cancelling waiting jobs* on page 15.)

Setup for polled transmit

- 1 Load your document.
- 2 Press  (Fax).
- 3 Press `Options`.
- 4 Press `^` or `v` on the Touchpanel to display `Polled TX`.
- 5 Press `Polled TX`.
- 6 Press `^` or `v` to display `Standard`.
- 7 Press `Standard`.
- 8 Press `Fax Start`.
- 9 If you are using the scanner glass, the Touchscreen will prompt you to choose one of the following options:
 - Press `Yes` to scan another page. Go to step 10.
 - Press `No (Send)` to store the document in memory. Other fax machines can now call your machine and retrieve the document.

- 10 Place the next page on the scanner glass and press `OK`. Repeat steps 9 and 10 for each additional page. The document will be stored in memory and will be sent when it is polled.

Setup for polled transmit with secure code

Secure Polling lets you restrict who can get the documents you set up to be polled.

Secure Polling only works with Brother fax machines. If another person wants to retrieve a fax from your machine, they will have to enter the secure code.

- 1 Load your document.
- 2 Press  (Fax).
- 3 Press `Options`.
- 4 Press `^` or `v` on the Touchpanel to display `Polled TX`.
- 5 Press `Polled TX`.
- 6 Press `^` or `v` to display `Secure`.
- 7 Press `Secure`.
- 8 Enter a four-digit number. Press `OK`.
- 9 Press `Fax Start`.
- 10 If you are using the scanner glass, the Touchscreen will prompt you to choose one of the following options:
 - Press `Yes` to scan another page. Go to step 11.
 - Press `No (Send)` to send the document.
- 11 Place the next page on the scanner glass and press `OK`.
- 12 Repeat steps 10 and 11 for each additional page. The document will be stored in memory and wait to be polled.

Receiving a fax (MFC models only)

Memory Receive (Monochrome only)



You can only use one Memory Receive operation at a time:

- Fax Forwarding
- Fax Storage
- PC-Fax Receive
- Off

You can change your selection at any time. If received faxes are still in the machine's memory when you change the Memory Receive operation, a message will appear on the Touchscreen. (See *Changing Memory Receive operations* on page 20.)

Fax Forwarding

When you choose Fax Forward, your machine stores the received fax in the memory. The machine will then dial the fax number you have programmed and forward the fax message.

- 1 Press  (Settings).
- 2 Press  or  on the Touchpanel to display Fax.
- 3 Press Fax.
- 4 Press  or  to display Setup Receive.
- 5 Press Setup Receive.
- 6 Press  or  to display Memory Receive.
- 7 Press Memory Receive.
- 8 Press  or  to display Fax Forward.

- 9 Press Fax Forward.
- 10 Enter the forwarding number (up to 20 digits) using the keyboard on the Touchscreen.
Press OK.
- 11 Press Backup Print:On or Backup Print:Off.

IMPORTANT

- If you choose Backup Print:On, the machine will also print the fax at your machine so you will have a copy. This is a safety feature in case there is a power failure before the fax is forwarded or a problem at the receiving machine.
- When you receive a colour fax, your machine prints the colour fax at your machine but does not forward the fax to the fax forwarding number you programmed.

- 12 Press .

Fax Storage

If you choose Fax Storage, your machine stores received faxes in the memory. You will be able to retrieve fax messages from another location using the remote retrieval commands.

If you have turned on Fax Storage, a backup copy will automatically be printed at the machine.

- 1 Press  (Settings).
- 2 Press **^** or **v** on the Touchpanel to display Fax.
- 3 Press Fax.
- 4 Press **^** or **v** to display Setup Receive.
- 5 Press Setup Receive.
- 6 Press **^** or **v** to display Memory Receive.
- 7 Press Memory Receive.
- 8 Press **^** or **v** to display Fax Storage.
- 9 Press Fax Storage.
- 10 Press .

NOTE

Colour faxes cannot be stored in the memory. When you receive a colour fax, your machine prints the colour fax at your machine.

Printing a fax from the memory

If you have chosen Fax Storage, you can still print a fax from the memory when you are at your machine.

- 1 Press  (Settings).
- 2 Press **^** or **v** on the Touchpanel to display Fax.
- 3 Press Fax.
- 4 Press **^** or **v** to display Print Document.
- 5 Press Print Document.
- 6 Press Start.
- 7 Press .

NOTE

When you print a fax from the memory, the fax data will be erased from your machine.

PC-Fax Receive (Windows® only)

If you turn on the PC-Fax Receive feature, your machine will store received faxes in the memory and send them to your PC automatically. You can then use your PC to view and store these faxes.

Even if you have turned off your PC (for example, at night or at the weekend), your machine will receive and store your faxes in its memory.

When you start your PC and the PC-FAX Receiving software runs, your machine transfers your faxes to your PC automatically.

To transfer the received faxes to your PC you must have the PC-FAX Receiving software running on your PC. (See Software User's Guide: *PC-FAX receiving*.)

If you choose `Backup Print:On`, the machine will also print the fax.

- 1 Press  (Settings).
- 2 Press **▲** or **▼** on the Touchpanel to display `Fax`.
- 3 Press `Fax`.
- 4 Press **▲** or **▼** to display `Setup Receive`.
- 5 Press `Setup Receive`.
- 6 Press **▲** or **▼** to display `Memory Receive`.
- 7 Press `Memory Receive`.
- 8 Press **▲** or **▼** to display `PC Fax Receive`.
- 9 Press `PC Fax Receive`.
- 10 The Touchscreen shows the message `Run PC-Fax on your computer`. Press `OK`.

- 11 Press `<USB>` or the name of the PC you want to receive faxes if you are on a network.
- 12 Press `Backup Print:On` or `Backup Print:Off`.
- 13 Press .

NOTE

- PC-Fax Receive is not supported by Mac OS.
- Before you can set up PC-Fax Receive, you must install the MFL-Pro Suite software on your PC. Make sure your PC is connected and turned on. (See Software User's Guide: *PC-FAX receiving*.)
- If you get an error message and the machine cannot print the faxes in the memory, you can use this setting to transfer your faxes to your PC. (See Basic User's Guide: *Transferring your faxes or Fax Journal report*.)
- When you receive a colour fax, your machine prints the colour fax at your machine but does not send the fax to your PC.
- To change the destination PC, repeat steps 1 to 13.

Turning off Memory Receive operations

- 1 Press  (Settings).
- 2 Press  or  on the Touchpanel to display Fax.
- 3 Press Fax.
- 4 Press  or  to display Setup Receive.
- 5 Press Setup Receive.
- 6 Press  or  to display Memory Receive.
- 7 Press Memory Receive.
- 8 Press Off.
- 9 Press .

NOTE

The Touchscreen will show you more options if there are received faxes still in the machine's memory. (See *Changing Memory Receive operations* on page 20.)

Changing Memory Receive operations

If there are received faxes in your machine's memory when you change the Memory Receive operations, the Touchscreen will ask you one of the following questions:

If all the received faxes have already been printed

- Erase All Doc?
 - If you press **Yes**, faxes in the memory will be erased before the setting changes.
 - If you press **No**, faxes in the memory will not be erased and the setting will be unchanged.

If unprinted faxes remain in the memory

- Print All Fax?
 - If you press **Yes**, faxes in the memory will be printed before the setting changes. If a backup copy has already been printed, it will not be printed again.
 - If you press **No**, faxes in the memory will not be printed and the setting will be unchanged.

If received faxes are left in the machine's memory when you change to PC Fax Receive from another option [Fax Forward or Fax Storage], press <USB> or the name of the PC if you are on a network.

The Touchscreen will ask you the following question:

- Send Fax to PC?
 - If you press **Yes**, faxes in the memory will be sent to your PC before the setting changes. You will be asked if you want to turn on Backup Print. (For more information, see *PC-Fax Receive (Windows® only)* on page 19.)
 - If you press **No**, faxes in the memory will not be erased or transferred to your PC and the setting will be unchanged.

Remote Retrieval

You can call your machine from any touch-tone telephone or fax machine and then use the remote access code and remote commands to retrieve fax messages.

Setting a Remote Access Code

The Remote Access Code lets you access the remote retrieval features when you are away from your machine. Before you can use the remote access and retrieval features, you have to set up your own code. The factory default code is the inactive code (---*).

- 1 Press  (Settings).
- 2 Press \wedge or \vee on the Touchpanel to display Fax.
- 3 Press Fax.
- 4 Press \wedge or \vee to display Remote Access.
- 5 Press Remote Access.
- 6 Enter a three-digit code using numbers 0 to 9, *, or # using the keyboard on the Touchscreen.
Press OK.
(The preset '*' cannot be changed.)

NOTE

Do not use the same code as your Remote Activation Code (* 5 1 (* 9 1 for New Zealand)) or Remote Deactivation Code (# 5 1 (# 9 1 for New Zealand)). (See Basic User's Guide: *Operation from external and extension telephones.*)

- 7 Press .

NOTE

You can change your code at any time by entering a new one. If you want to make your code inactive, press  in step 6 to restore the inactive setting (---*) and press OK.

Using your Remote Access Code

- 1 Dial your fax number from a touch-tone telephone or another fax machine.
- 2 When your machine answers, enter your remote access code (3 digits followed by *) at once.
- 3 The machine signals if it has received messages:
 - 1 long beep — Fax messages
 - No beeps — No messages
- 4 When the machine gives two short beeps, enter a command.
The machine will hang up if you wait longer than 30 seconds to enter a command.
The machine will beep three times if you enter an invalid command.
- 5 Press 9 0 to stop Remote Access when you have finished.
- 6 Hang up.

NOTE

If your machine is set to Manual mode and you want to use the remote retrieval features, wait for about 100 seconds after it starts ringing, and then enter the remote access code within 30 seconds. This function may not be available in some countries e.g. Australia.

Remote Fax commands

Follow the commands below to access features when you are away from the machine. When you call the machine and enter your remote access code (3 digits followed by *), the system will give two short beeps and you must enter a remote command.

Remote commands		Operation
95	Change the Fax Forwarding or Fax Storage settings	
	1 OFF	You can choose OFF after you have retrieved or erased all your messages.
	2 Fax Forwarding	One long beep means the change is accepted. If you hear three short beeps, the change was not accepted because something has not been set up (for example, a Fax Forwarding number has not been registered). You can register your Fax Forwarding number by entering 4. (See <i>Changing your Fax Forwarding number</i> on page 23.) Once you have registered the number, Fax Forwarding will work.
	4 Fax Forwarding number	
	6 Fax Storage	
96	Retrieve a fax	
	2 Retrieve all faxes	Enter the number of a remote fax machine to receive stored fax messages. (See <i>Retrieving fax messages</i> on page 23.)
	3 Erase faxes from the memory	If you hear one long beep, fax messages have been erased from the memory.
97	Check the receiving status	
	1 Fax	You can check whether your machine has received any faxes. If yes, you will hear one long beep. If no, you will hear three short beeps.
98	Change the Receive Mode	
	1 External TAD	If you hear one long beep, your change has been accepted.
	2 Fax/Tel	
	3 Fax Only	
90	Exit	Pressing 9 0 allows you to exit remote retrieval. Wait for the long beep, then replace the handset.

Retrieving fax messages

You can call your machine from any touch-tone telephone and have your fax messages sent to another machine. Before you use this feature, you have to turn on Fax Storage. (See *Fax Storage* on page 18.)

- 1 Dial your fax number.
- 2 When your machine answers, enter your remote access code (3 digits followed by *) at once. If you hear one long beep, you have messages.
- 3 When you hear two short beeps, press **9 6 2**.
- 4 Wait for a long beep, and then use the dial pad to enter the number of the remote fax machine where you want your fax messages sent, followed by **# #** (up to 20 digits).

NOTE

You cannot use * and # as dial numbers. However, press # if you want to create a pause.

- 5 Hang up after you hear your machine beep. Your machine will call the other fax machine, which will then print your fax messages.

Changing your Fax Forwarding number

You can change the default setting of your fax forwarding number from another touch-tone telephone or fax machine.

- 1 Dial your fax number.
- 2 When your machine answers, enter your remote access code (3 digits followed by *) at once. If you hear one long beep, you have messages.
- 3 When you hear two short beeps, press **9 5 4**.
- 4 Wait for the long beep, enter the new number (up to 20 digits) of the remote fax machine you want your fax messages forwarded to using the dial pad, then enter **# #**.

NOTE

You cannot use * and # as dial numbers. However, press # if you want to create a pause.

- 5 Press **9 0** to stop Remote Access when you have finished.
- 6 Hang up after you hear your machine beep.

Additional receiving operations

Out of Paper Reception

As soon as the paper tray becomes empty during fax reception, the Touchscreen shows **No Paper Fed**. Put some paper in the paper tray. (See Basic User's Guide: *Loading paper and other print media*.)

If you do not put paper in the paper tray, the machine will carry on receiving the fax, with the remaining pages being stored in the memory, if enough memory is available.

Further incoming faxes will also be stored in memory until the memory is full. To print the faxes, put fresh paper in the tray. When the memory is full, the machine will stop automatically answering calls.

Printing a reduced incoming fax

If you choose **On**, the machine automatically reduces each page of an incoming fax to fit on one page of A4 or Letter size paper. The machine calculates the reduction ratio by using the page size of the fax and your Paper Size setting.

(MFC-J2310 and MFC-J4410DW: See Basic User's Guide: *Paper Size*.)

(MFC-J4610DW: See Basic User's Guide: *Paper Size and Type (MFC-J4610DW)*.)

- 1 Press  (Settings).
- 2 Press **^** or **v** on the Touchpanel to display **Fax**.
- 3 Press **Fax**.
- 4 Press **^** or **v** to display **Setup Receive**.
- 5 Press **Setup Receive**.

- 6 Press **^** or **v** to display **Auto Reduction**.
- 7 Press **Auto Reduction**.
- 8 Press **On** (or **Off**).
- 9 Press .

Receiving a fax at the end of a conversation

At the end of a conversation, you can ask the other party to send you a fax before you both hang up.

- 1 Ask the other party to place the document in their machine and to press the **Start** or **Send** key.
- 2 When you hear the other machine's CNG tones (slowly repeating beeps), press **Fax Start**.

NOTE

If the Touchscreen has dimmed, touch it to display **Fax Start**.

- 3 Press **Receive** to receive the fax.
- 4 Replace the handset of the external telephone.



Temporary Fax Backup

When Memory Receive is turned off, your machine has a safety feature called Temporary Fax Backup that you can turn on. The machine reserves 2 MB of memory to temporarily store up to five of the last faxes you received. Faxes will remain in the memory up to 10 days or until faxes that are received later require the space, whichever comes first. If the memory becomes full, the oldest faxes will be deleted. The factory setting is *Off*.

NOTE



Colour faxes cannot be stored in the memory.

Turning Temporary Fax Backup On/Off

- 1 Press  (Settings).
- 2 Press **^** or **v** on the Touchpanel to display *Initial Setup*.
- 3 Press *Initial Setup*.
- 4 Press **^** or **v** to display *Miscellaneous*.
- 5 Press *Miscellaneous*.
- 6 Press *Temporary Fax Backup*.
- 7 Press *Backup*.
- 8 Press *On* (or *Off*).
- 9 Press .



Printing temporarily stored faxes

While the faxes are in the memory, you can print them as many times as you wish without deleting them.

- 1 Press  (Settings).
- 2 Press **^** or **v** on the Touchpanel to display *Initial Setup*.
- 3 Press *Initial Setup*.
- 4 Press **^** or **v** to display *Miscellaneous*.
- 5 Press *Miscellaneous*.
- 6 Press *Temporary Fax Backup*.
- 7 Press *Reprint*.
- 8 Press *OK*.
- 9 Press .

Deleting temporarily stored faxes

You can delete all the recovered faxes from the memory at any time.

- 1 Press  (Settings).
- 2 Press **^** or **v** on the Touchpanel to display *Initial Setup*.
- 3 Press *Initial Setup*.
- 4 Press **^** or **v** to display *Miscellaneous*.
- 5 Press *Miscellaneous*.
- 6 Press *Temporary Fax Backup*.
- 7 Press **^** or **v** to display *Delete*.
- 8 Press *Delete*.
- 9 Press *Yes* to confirm.
- 10 Press *OK*.
- 11 Press .

Polling overview

Polling lets you set up your machine so other people can receive faxes from you, but they pay for the call. It also lets you call somebody else's fax machine and receive a fax from it, so you pay for the call. The polling feature needs to be set up on both machines for this to work. Not all fax machines support polling.

Polling receive

Polling receive lets you call another fax machine to receive a fax.

Setup to receive polling

- 1 Press  (Fax).
- 2 Press **Options**.
- 3 Press **▲** or **▼** on the Touchpanel to display **Polling RX**.
- 4 Press **Polling RX**.
- 5 Press **▲** or **▼** to display **Standard**.
- 6 Press **Standard**.
- 7 Enter the fax number you are polling using **Speed Dial** or the dial pad on the Touchpanel.
- 8 Press **Fax Start**.

Setup to receive polling with secure code

Secure Polling lets you restrict who can get the documents you set up to be polled.

Secure Polling only works with Brother fax machines. If you want to get a fax from a secured Brother machine you have to enter the secure code.

- 1 Press  (Fax).
- 2 Press **Options**.

- 3 Press **▲** or **▼** on the Touchpanel to display **Polling RX**.
- 4 Press **Polling RX**.
- 5 Press **▲** or **▼** to display **Secure**.
- 6 Press **Secure**.
- 7 Enter a four-digit secure code using the keyboard on the Touchscreen. This is the same as the security code of the fax machine you are polling. Press **OK**.
- 8 Enter the fax number you are polling by either using **Speed Dial** or the dial pad on the Touchpanel.
- 9 Press **Fax Start**.



Setup to receive delayed polling

Delayed polling lets you set the machine to begin polling receive at a later time. You can only set up *one* delayed polling operation.

- 1 Press  (Fax).
- 2 Press **Options**.
- 3 Press **▲** or **▼** on the Touchpanel to display **Polling RX**.
- 4 Press **Polling RX**.
- 5 Press **Timer**.
- 6 Enter the time (in 24-hour format) you want to start polling. For example, enter 21:45 for 9:45 PM. Press **OK**.
- 7 Enter the fax number you are polling by either using **Speed Dial** or the dial pad on the Touchpanel.
- 8 Press **Fax Start**. The machine makes the polling call at the time you entered.

Sequential polling (Monochrome only)

Sequential polling lets you request documents from several fax machines in one operation.



- 1 Press  (Fax).
- 2 Press **Options**.
- 3 Press **^** or **v** on the Touchpanel to display **Polling RX**.
- 4 Press **Polling RX**.
- 5 Press **Standard**, **Secure** or **Timer**.
- 6 Do one of the following:
 - If you chose **Standard**, go to step 7.
 - If you chose **Secure**, enter a four-digit number, press **OK**, go to step 7.
 - If you chose **Timer**, enter the time (24-hour format) you want to begin polling and press **OK**, go to step 7.
- 7 Press **Options**. Press **^** or **v** to display **Broadcasting**.
- 8 Press **Broadcasting**.
- 9 Press **Add from Address Book**. Press  to choose alphabetical order or numerical order. Press the check boxes of the numbers you want to add to the broadcast. After you have checked all the numbers you want to add, press **OK**.
- 10 Press **^** or **v** to review and confirm the displayed list of numbers to be polled, and then press **OK** to accept it.
- 11 If you are finished changing settings, press **OK**.

- 12 Press **Fax Start**. The machine polls each number or group in turn for a document.

Press  while the machine is dialling to cancel the polling process.

To cancel all sequential polling receive jobs, see *Cancelling a Sequential Polling Job* on page 27.

Cancelling a Sequential Polling Job

- 1 Press .
- 2 Do one of the following:
 - To cancel the entire sequential polling job, press **Entire Seq. Poll**. Go to step 3.
 - To cancel the current job, press the number being dialled on the Touchscreen. Go to step 4.
 - To exit without cancelling, press .
- 3 When the Touchscreen asks if you want to cancel the entire sequential polling job, do one of the following:
 - Press **Yes** to confirm.
 - To exit without cancelling, press **No**.
- 4 Do one of the following:
 - To cancel the current job, press **Yes**.
 - To exit without cancelling, press **No**.

5



Dialling and storing numbers (MFC models only)

Additional dialling operations

Combining Speed Dial numbers

Sometimes, you may want to choose from several long-distance carriers when you send a fax. Rates may vary depending on the time of day you're sending the fax and the destination to which you're sending it. To take advantage of low rates, you can store the access codes of long-distance carriers and credit card numbers as Speed Dial numbers. You can store these long dialling sequences by dividing them and setting them up as separate Speed Dial numbers in any combination. You can even include manual dialling using the dial pad. (See Basic User's Guide: *Storing Speed Dial numbers.*)

For example, you might have stored '01632' on Address Book: 03 and '960555' on Address Book: 02. You can use them both to dial '01632-960555' if you press the following buttons on the Touchscreen:

- 1 Press  (Fax).
- 2 Press  (Address).
- 3 Press Numerical.
- 4 Press **^** or **v** on the Touchpanel to display #03.
- 5 Press #03.
- 6 Press Send a fax.
- 7 Press Options.
- 8 Press **^** or **v** to display Address Book.

- 9 Press Address Book.
- 10 Press Numerical.
- 11 Press **^** or **v** to display #02.
- 12 Press #02.
- 13 Press Send a fax.
- 14 Press Fax Start.
You will dial '01632-960555'.

To temporarily change a number, you can substitute part of the number with manual dialling using the dial pad. For example, to change the number to 01632-960556 you

could press  (Address), press **03**, press Send a fax, and then press **960556** using the dial pad.

NOTE

If you must wait for another dial tone or signal at any point in the dialling sequence, create a pause in the number by pressing **Pause**. Each key press adds a 3.5 second delay. You can press **Pause** as many times as needed to increase the length of the pause.

Additional ways to store numbers

Storing Speed Dial numbers from Outgoing Calls



You can also store Speed Dial numbers from the Outgoing Call history.

1 Press  (Fax).

2 Press  (History).

NOTE

You can also add numbers from the history in a different way by pressing Settings, Fax, Setup AddressBook, Set Speed Dial, and Add Number from History.

3 Press  or  on the Touchpanel to display the name or number you want to store.

4 Press the name or number you want to store.

5 Press More.

6 Press Add to Address Book.

7 Do one of the following:

- Enter the name (up to 16 characters) using the keyboard on the Touchscreen.

(To help you enter letters, see Basic User's Guide: *Entering Text*.)

Press OK.

- To store the number without a name, press OK.

8 Press OK to confirm the fax or telephone number you want to store.

9 Do one of the following:

- Enter the second fax or telephone number (up to 20 digits) using the keyboard on the Touchscreen.

Press OK.

- If you do not want to store a second number, press OK.

10 To choose where the number will be stored, do one of the following:

- To accept the next available Speed Dial location that is displayed, press OK.

- To enter a different Speed Dial location, press  and then enter a 2-digit number using the keyboard on the Touchscreen.

Press OK.

NOTE

If the 2-digit Speed Dial location you choose is already taken, the OK button on the Touchscreen will not work. Choose a different location.

11 When the Touchscreen displays your settings, press OK to confirm.

12 Press .

Storing Speed Dial numbers from the Caller ID history

If you have the Caller ID subscriber service from your telephone company, you can also store Speed Dial numbers from incoming calls in the Caller ID History. (See Basic User's Guide: *Caller ID*.)



1 Press  (Fax).

2 Press  (History).

NOTE

You can also add numbers from the history in a different way by pressing Settings, Fax, Setup AddressBook, Set Speed Dial, and Add Number from History.

3 Press  (Incoming).

4 Press  or  on the Touchpanel to display the number you want to store.

5 Press the number you want to store.

6 Press More.

7 Press Add to Address Book.

8 Do one of the following:

- Enter the name (up to 16 characters) using the keyboard on the Touchscreen.
(To help you enter letters, see Basic User's Guide: *Entering Text*)
Press OK.
- To store the number without a name, press OK.

9 Press OK to confirm the fax or telephone number you want to store.

10 Do one of the following:

- Enter a second fax or telephone number (up to 20 digits) using the keyboard on the Touchscreen.

Press OK.

- If you do not want to store a second number, press OK.

11 To choose where the number will be stored, do one of the following:

- To accept the next available Speed Dial location that is displayed, press OK.

- To enter a different Speed Dial location, press  and then enter a 2-digit number using the keyboard on the Touchscreen.

Press OK.

NOTE

If the 2-digit Speed Dial location you choose is already taken, the OK button on the Touchscreen will not work. Choose a different location.

12 When the Touchscreen displays your settings, press OK to confirm.

13 Press .

Setting up Groups for Broadcasting

A Group, which can be stored in a Speed Dial location, allows you to send the same fax message to many fax numbers by pressing



(Address), the two-digit location,

Send a fax and Fax Start.

First, you'll need to store each fax number in a Speed Dial location. (See Basic User's Guide: *Storing Speed Dial numbers*.) Then you can include them as numbers in the Group. Each Group uses up a Speed Dial location. You can have up to six Groups, or you can assign up to 198 numbers to a large Group.

(See *Broadcasting (Monochrome only)* on page 12.)

- 1 Press (Fax).
- 2 Press (Address).
- 3 Press **Alphabetical** or **Numerical**.
- 4 Press **More**.
- 5 Press **▲** or **▼** on the Touchpanel to display **Setup Groups**.
- 6 Press **Setup Groups**.
- 7 Enter the Group name (up to 16 characters) using the keyboard on the Touchscreen.
Press **OK**.
- 8 When the Touchscreen displays the next available Group number, press **OK**. This Group number and name will automatically be assigned to the next available Speed Dial location.

- 9 Add Speed Dial numbers to the Group by pressing them to display a red checkmark. Press **OK**.
If you want to list the numbers in alphabetical order, press .
- 10 When the Touchscreen displays the Group Name and numbers, press **OK** to confirm.
- 11 Do one of the following:
 - To store another Group for broadcasting, repeat steps 4 to 10.
 - To finish storing Groups for broadcasting, press .

NOTE

You can print a list of all the Speed Dial numbers. (See *Reports* on page 34.)

Changing a Group name

- 1 Press (Fax).
- 2 Press (Address).
- 3 Press **Alphabetical** or **Numerical**.
- 4 Press **More**.
- 5 Press **▲** or **▼** on the Touchpanel to display **Change**.
- 6 Press **Change**.
- 7 Press **▲** or **▼** to display the Group you want to change.
- 8 Press the Group.
- 9 Press **Name**.
- 10 Enter the new name (up to 16 characters) using the keyboard on the Touchscreen.
Press **OK**.
(For example, type NEW CLIENTS.)

NOTE

How to change the stored name:

If you want to change a character, press ◀ or ▶ to position the cursor under the character you want to change, and then press . Enter the new character.

(See Basic User's Guide: *Entering Text*.)

11 Press OK.

12 Press .

Deleting a Group

1 Press  (Fax).

2 Press  (Address).

3 Press **Alphabetical** or **Numerical**.

4 Press **More**.

5 Press ▲ or ▼ on the Touchpanel to display **Delete**.

6 Press **Delete**.

7 Press ▲ or ▼ to display the Group you want to delete.

8 Press the Group name.

9 Press OK.
Press **Yes** to confirm.

10 Press .

Adding or Deleting a number in a Group

1 Press  (Fax).

2 Press  (Address).

3 Press **Alphabetical** or **Numerical**.

4 Press **More**.

5 Press ▲ or ▼ on the Touchpanel to display **Change**.

6 Press **Change**.

7 Press ▲ or ▼ to display the Group you want to change.

8 Press the Group.

9 Press ▲ or ▼ to display **Change**.

10 Press **Change**.

11 Press ▲ or ▼ to display the number you want to add or delete.

12 Do the following for each number you want to change:

- To add a number to the Group, press the check box of the number to *add* a check mark.
- To delete a number from the Group, press the check box of the number to *remove* the check mark.

Press OK to confirm all your changes.

13 Press OK.

14 Press .

Fax reports (MFC models only)

Press  (Settings) on the Touchscreen to set up the Transmission Verification Report and the Journal Period.

Transmission Verification Report

You can use the Transmission Verification Report as proof that you sent a fax. (See Basic User's Guide: *Transmission Verification Report*.)

Fax Journal (activity report)

You can set the machine to print a journal at specific intervals (every 50 faxes, 6, 12 or 24 hours, 2 or 7 days). If you set the interval to **Off**, you can still print the report by following the steps in *How to print a report* on page 34. The factory default is **Every 50 Faxes**.

- 1 Press  (Settings).
- 2 Press **^** or **v** on the Touchpanel to display **Fax**.
- 3 Press **Fax**.
- 4 Press **^** or **v** to display **Report Setting**.
- 5 Press **Report Setting**.
- 6 Press **Journal Period**.
- 7 Press **^** or **v** to display the intervals.

- 8 Press the option you want to set. If you choose **Every 50 Faxes**, go to step 11.

- **6, 12, 24 hours, 2 or 7 days**

The machine will print the report at the chosen time and then erase all jobs from its memory. If the machine's memory is filled with the maximum 200 jobs before the time you chose has passed, the machine will print the Fax Journal report early and then erase all jobs from the memory. If you want an extra report before it is due to print, you can print it without erasing the jobs from the memory.

- **Every 50 Faxes**

The machine will print the Fax Journal report when the machine has stored 50 jobs.



- 9 Enter the time to start printing in 24-hour format. Press **OK**. (For example: enter 19:45 for 7:45 PM.)
- 10 If you choose **Every 7 Days**, choose the first day for the 7-day countdown.
- 11 Press .

Reports

The following reports are available:

- **XMIT Verify**
(MFC models only)
Prints a Transmission Verification Report for your last transmission.
- **Address Book**
(MFC models only)
Lists names and numbers stored in the Address Book memory, in alphabetical or numerical order.
- **Fax Journal**
(MFC models only)
Lists information about the last incoming and outgoing faxes.
(TX: Transmit.) (RX: Receive.)
- **User Settings**
Lists your settings.
- **Network Config**
Lists your Network settings.
- **WLAN Report**
Prints a WLAN connection report.
- **Caller ID hist.**
(MFC models only)
Lists the available Caller ID information about the last 30 received faxes and telephone calls.

How to print a report

- 1 Press  (Settings).
- 2 Press **^** or **v** on the Touchpanel to display **Print Reports**.
- 3 Press **Print Reports**.
- 4 Press the report you want to print.
- 5 (Address Book ¹ Only) Press **Alphabetical Order** or **Numerical Order**.
¹ MFC models only.
- 6 Press **Start**.
- 7 Press .

Copy options

You can change the copy settings temporarily for the next copy.

The machine returns to its default settings after being idle for one minute.

To change a setting, press **Copy, Options** and then press **▲** or **▼** on the Touchpanel to scroll through the copy settings. When the setting you want is displayed, press it and choose your preferred option.

When you have finished choosing settings, press **Mono Start** or **Colour Start**.

NOTE

- You can save some of the options that you use most often by setting them as the default settings. These settings will remain until you change them again. (See *Setting your changes as a new default* on page 44.)
- The **Ink Save Mode**, **Thin Paper Copy** and **Book Copy** features are supported by technology from Reallusion, Inc.



Stop copying

To stop copying, press **✖**.

Changing copy speed and quality

You can choose from a range of speed and quality. The factory default is **Normal**.

■ Normal

Normal is the recommended mode for ordinary print outs. This produces good copy quality with good copy speed.

NOTE

If you choose **Normal**, you can only choose **Plain Paper** in **Paper Type**.

■ Best

Use **Best** mode to copy precise images such as photographs. This provides the highest resolution and slowest speed.

- 1 Load your document.
- 2 Press  (**Copy**).
- 3 Enter the number of copies you want.
- 4 Press **Options**.
- 5 Press **▲** or **▼** on the Touchpanel to display **Quality**.
- 6 Press **Quality**.
- 7 Press **Normal** or **Best**.
- 8 Press **OK**.
- 9 If you do not want to change additional settings, press **Mono Start** or **Colour Start**.

Enlarging or reducing the copied image

You can choose an enlargement or reduction ratio. If you choose **Fit to Page**, your machine will adjust the size automatically to the paper size you set.

- 1 Load your document.
- 2 Press  (Copy).
- 3 Enter the number of copies you want.
- 4 Press **Options**.
- 5 Press **^** or **v** on the Touchpanel to display **Enlarge/Reduce**.
- 6 Press **Enlarge/Reduce**.
- 7 Press **^** or **v** to display the available options, and then press the option you want to change.
- 8 Do one of the following:
 - If you chose **Enlarge** or **Reduce**, press the enlargement or reduction ratio you want to use.
 - If you chose **Custom (25-400%)**, enter an enlargement or reduction ratio from 25% to 400%.
Press **OK**.
 - If you chose **100%** or **Fit to Page**, go to step 9.

198% 10x15cm→A4
186% 10x15cm→LTR
141% A4→A3, A5→A4
100%
97% LTR→A4
93% A4→LTR
83% (MFC-J2310 and DCP-J4110DW)
83% LGL→A4 (MFC-J4410DW and MFC-J4610DW)
69% A4→A5
47% A4→10x15cm
Fit to Page
Custom (25-400%)

- 9 Press **^** or **v** to review and confirm the displayed list of settings for this copy. If you do not want to change additional settings, press **OK**.
- 10 Press **Mono Start** or **Colour Start**.

NOTE

- Page Layout is not available with **Enlarge/Reduce**.
- Page Layout, 2-sided Copy, Book Copy, Sort, Thin Paper Copy and Remove Background are not available with **Fit to Page**.
- **Fit to Page** does not work correctly when the document on the scanner glass is skewed more than 3 degrees. Using the document guidelines on the left and top, place your document in the upper-left hand corner, with the document face down on the scanner glass.
- **Fit to Page** is not available when using the ADF ¹.
¹ MFC-J4410DW and MFC-J4610DW only.
- **Fit to Page** is not available for Legal-size documents.

Making N in 1 copies or a poster (Page Layout)

The N in 1 copy feature can help you save paper by letting you copy two or four pages onto one printed page.

You can also produce a poster. When you use the poster feature, your machine divides your document into sections, then enlarges the sections so you can assemble them into a poster. If you want to print a poster, use the scanner glass.

NOTE

- Book Copy, Sort, Thin Paper Copy, Ink Save Mode, Remove Background and Enlarge/Reduce are not available with Page Layout.
- 2-sided Copy is not available with Poster copy.

- 1 Load your document.
 - 2 Press  (Copy).
 - 3 Enter the number of copies you want.
 - 4 Press Options.
 - 5 Press **▲** or **▼** on the Touchpanel to display Page Layout.
 - 6 Press Page Layout.
 - 7 Press **▲** or **▼** to display Off (1in1), 2in1 (P), 2in1 (L), 2in1 (ID) ¹, 4in1 (P), 4in1 (L), Poster (2x1), Poster (2x2) or Poster (3x3). Press the option you want to set.
- ¹ For information about 2 in 1 (ID), see *2 in 1 ID Copy (Page Layout)* on page 38.
- 8 Press **▲** or **▼** to review and confirm the displayed list of settings for this copy. If you do not want to change additional settings, press OK.

- 9 Press Mono Start or Colour Start to scan the page.

If you placed the document in the ADF ¹ or are making a poster, the machine scans the document and starts printing.

¹ MFC-J4410DW and MFC-J4610DW only.

If you are using the scanner glass, go to step 10.

- 10 After the machine scans the page, press Yes to scan the next page.
- 11 Place the next page on the scanner glass. Press OK to scan the page. Repeat steps 10 and 11 for each page of the layout.
- 12 After all the pages have been scanned, press No to finish.

NOTE

- Make sure the paper size is set to A4, A3, Letter or Ledger.
- You can only make one colour copy at a time.
- You can only make one Poster copy at a time.
- 2in1 (ID), 4in1 (P), 4in1 (L), Poster (2x1) and Poster (3x3) are not available when using A3 or Ledger size paper.

Place the document face down in the direction shown below:

■ 2in1 (P)



■ 2in1 (L)



■ 4in1 (P)



■ 4in1 (L)



■ Poster (2x1)

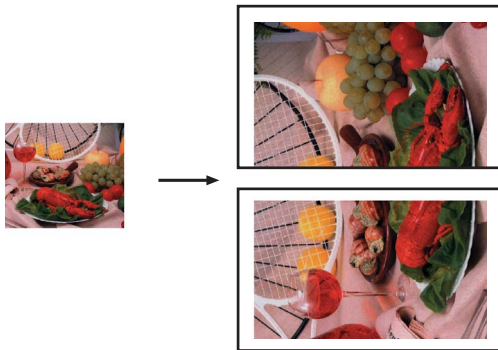

■ Poster (2x2)

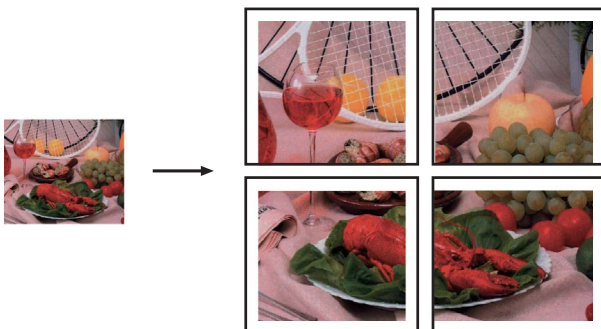

■ Poster (3x3)

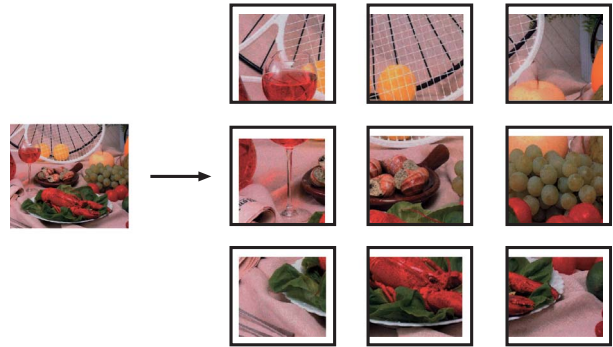

2 in 1 ID Copy (Page Layout)

You can copy both sides of your identification card onto one page, keeping the original card size. Make sure the paper size is set to A4 or Letter.

NOTE

You can copy an identification card to the extent permitted under applicable laws. (See Product Safety Guide: *Unlawful use of copying equipment.*)

- 1 Place your identification card *face down* near the left corner of the scanner glass as shown below.

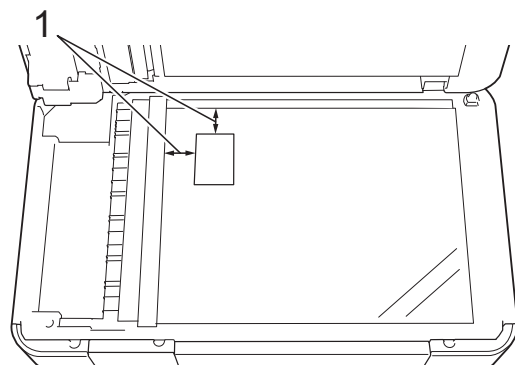

1 3 mm or greater (top, left)

- 2 Press  (Copy).
- 3 Enter the number of copies you want.
- 4 Press *Options*.

- 5 Press **▲** or **▼** on the Touchpanel to display **Page Layout**.
- 6 Press **Page Layout**.
- 7 Press **▲** or **▼** to display **2in1 (ID)**.
- 8 Press **2in1 (ID)**.
- 9 Press **OK**.
- 10 Press **Mono Start** or **Colour Start**. The machine scans the first side of the identification card.
- 11 After the machine has scanned the first side, press **Yes**. Turn over the identification card and place it at the left side of the scanner glass. Press **OK** to scan the other side.

NOTE

- **Book Copy, Sort, 2-sided Copy, Thin Paper Copy, Ink Save Mode, Remove Background and Enlarge/Reduce are not available with 2in1 (ID).**
- You can only make one colour copy at a time.

Sorting copies

You can sort multiple copies. Pages will be stacked in the order 123, 123, 123, and so on.

We recommend you load single-sided documents in the ADF¹ for sorting copies. For 2-sided documents and books use the scanner glass.

¹ MFC-J4410DW and MFC-J4610DW only.

- 1 Load your document.
- 2 Press  (Copy).
- 3 Enter the number of copies you want.
- 4 Press **Options**.

- 5 Press **▲** or **▼** on the Touchpanel to display **Stack/Sort**.
- 6 Press **Stack/Sort**.
- 7 Press **Sort**.
- 8 Press **OK**.
- 9 If you do not want to change additional settings, press **Mono Start** or **Colour Start**.
If you placed the document in the ADF¹, the machine scans the document and starts printing.

¹ MFC-J4410DW and MFC-J4610DW only.

If you are using the scanner glass, go to step 10.

- 10 After the machine scans the page, press **Yes** to scan the next page.
- 11 Place the next page on the scanner glass. Press **OK** to scan the page. Repeat steps 10 and 11 until all the pages have been scanned.
- 12 Press **No** to finish scanning. The machine starts printing.

NOTE

Fit to Page, Page Layout and Book Copy are not available with Sort.

Adjusting Density

You can adjust the copy density to make copies darker or lighter.

- 1 Load your document.
- 2 Press  (Copy).
- 3 Enter the number of copies you want.
- 4 Press `Options`.
- 5 Press `^` or `v` on the Touchpanel to display `Density`.
- 6 Press `Density`.
- 7 Press `◀` or `▶` to make a lighter or darker copy.
Press `OK`.
- 8 If you do not want to change additional settings, press `OK`, and then press `Mono Start` or `Colour Start`.

Ink Save Mode

Ink Save Mode can help you save ink. The machine prints the colours lighter and emphasises the outlines of the images as shown below:

The amount of ink saved will vary depending on the document.

Ink Save Mode: Off

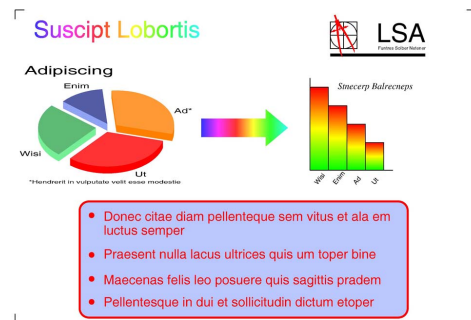

Ink Save Mode: On

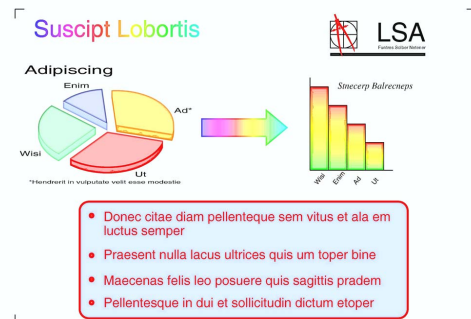

(The above screens are used in ISO/IEC 24712.)

- 1 Load your document.
- 2 Press  (Copy).
- 3 Enter the number of copies you want.
- 4 Press `Options`.
- 5 Press `^` or `v` on the Touchpanel to display `Advanced Settings`.

- 6 Press Advanced Settings.
- 7 Press Ink Save Mode.
- 8 Press OK.
- 9 If you do not want to change any additional settings, press Mono Start or Colour Start.

NOTE

- Book Copy, Thin Paper Copy, Page Layout and Remove Background are not available with Ink Save Mode.
- Ink Save Mode may make your printouts look different from your original document.

Thin Paper Copy

If your document is a 2-sided copy on thin paper, choose Thin Paper Copy so the print on the other side does not bleed through.

- 1 Load your document.
- 2 Press  (Copy).
- 3 Enter the number of copies you want.
- 4 Press Options.
- 5 Press **▲** or **▼** on the Touchpanel to display Advanced Settings.
- 6 Press Advanced Settings.
- 7 Press **▲** or **▼** to display Thin Paper Copy.
- 8 Press Thin Paper Copy.
- 9 Press OK.
- 10 Press Mono Start or Colour Start.

NOTE

Fit to Page, Page Layout, Ink Save Mode, Book Copy and Remove Background are not available with Thin Paper Copy.

Book Copy

Book Copy corrects dark borders and skew when copying from the scanner glass. Your machine can correct the data automatically.

- 1 Load your document.
- 2 Press  (Copy).
- 3 Enter the number of copies you want.
- 4 Press Options.
- 5 Press **▲** or **▼** on the Touchpanel to display Advanced Settings.
- 6 Press Advanced Settings.
- 7 Press **▲** or **▼** to display Book Copy.
- 8 Press Book Copy.
- 9 Press OK.
- 10 If you do not want to change additional settings, press Mono Start or Colour Start.

NOTE

Page Layout, Sort, 2-sided Copy, Ink Save Mode, Fit to Page, Thin Paper Copy and Remove Background are not available with Book Copy.

Remove Background Colour

Remove Background Colour removes the background colour of the document when copying. This can save ink and help you read the document clearly.

NOTE

This function is for use only when making colour copies. The background colour is automatically removed for all monochrome copies.

- 1 Load your document.
- 2 Press  (Copy).
- 3 Enter the number of copies you want.
- 4 Press **Options**.
- 5 Press **^** or **v** on the Touchpanel to display **Advanced Settings**.
- 6 Press **Advanced Settings**.
- 7 Press **^** or **v** to display **Remove Background**.
- 8 Press **Remove Background**.
- 9 Press **Low**, **Medium** or **High**.
- 10 Press **OK**.
- 11 Press **Colour Start**.

NOTE

Fit to Page, Page Layout, Ink Save Mode, Thin Paper Copy and Book Copy are not available with Remove Background.

2-sided copying

You can reduce the amount of paper used for copies by copying on both sides of the paper.

We recommend you load single-sided documents in the ADF ¹ for 2-sided copying. For 2-sided documents and books use the scanner glass.

¹ MFC-J4410DW and MFC-J4610DW only.

(Long edge flip)

Portrait

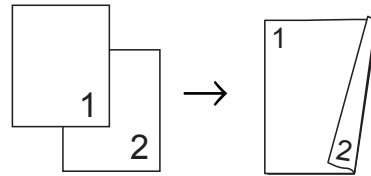

Landscape

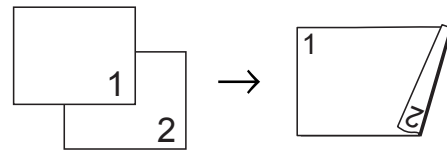

(Short edge flip)

Portrait

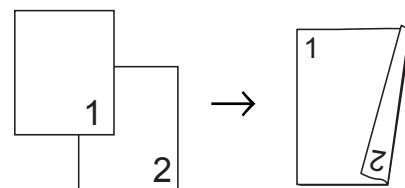

Landscape

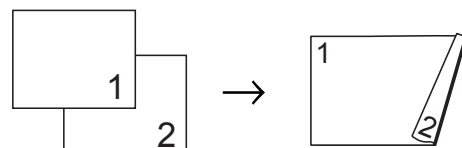

NOTE

- 2in1 (ID), Poster, Book Copy and Fit to Page are not available with 2-sided Copy.
- You can use only A4, A5 or Letter size plain paper.

- 1 Load your document.
- 2 Press  (Copy).
- 3 Enter the number of copies you want.
- 4 Press Options.
- 5 If you want to sort multiple copies, press **▲** or **▼** on the Touchpanel to display Stack/Sort.
- 6 Press Stack/Sort.
- 7 Press Sort.
- 8 Press **▲** or **▼** to display 2-sided Copy.
- 9 Press 2-sided Copy.
- 10 Press **▲** or **▼** to display the 2-sided copy layout you want to use, and press Portrait LongEdgeFlip, Landscape LongEdgeFlip, Portrait ShortEdgeFlip or Landscape ShortEdgeFlip.
- 11 (MFC-J4410DW and MFC-J4610DW) Press **OK** after reading the message on the Touchscreen.
- 12 Press **OK**.
- 13 Press Mono Start or Colour Start. If you placed the document in the ADF ¹, the machine scans the pages and starts printing.

¹ MFC-J4410DW and MFC-J4610DW only.

If you are using the scanner glass, go to step 14.

- 14 The Touchscreen shows:

Set the next page, then press Scan. When you finish, press Complete.

Place the next page on the scanner glass and press Scan.

Press **OK**.

The machine starts printing.

- 15 If you pressed Sort for multiple copies, repeat step 14 for each additional page. After all the pages have been scanned, press Complete. The machine starts printing.

DO NOT touch printed pages until they are ejected the second time. The machine will print and eject the first side, and then pull the paper back in to print the second side.

NOTE



If your document causes paper jams, try using one of the special 2-sided copy settings. Press Advanced after step 9. Press **▲** or **▼** to choose 2-sided1 or 2-sided2. 2-sided1 helps avoid paper jams when copying by allowing more time for the ink to dry. Choosing 2-sided2 allows more time for the ink to dry while also using less ink.

Setting your changes as a new default

You can save the settings for the copy options you use most often by setting them as default, such as Quality, Tray Select ¹, Enlarge/Reduce, Density, Page Layout, Ink Save Mode, Thin Paper Copy, Remove Background and 2-sided Copy.

These settings will remain until you change them again.



¹ MFC-J4610DW only.

- 1 Press  (Copy).
- 2 Press Options.
- 3 Press **^** or **v** on the Touchpanel to display the settings, and press on the setting you want to change. Then press the new option.
Repeat this step for each setting you want to change.
- 4 After changing the last setting, press **^** or **v** to display Set New Default.
- 5 Press Set New Default.
- 6 Press OK.
The Touchscreen asks you again to confirm if you want to set the changes as the new default settings.
Press Yes.
- 7 Press .

Restoring all settings to the factory default

You can restore the copy settings Quality, Tray Select ¹, Enlarge/Reduce, Density, Page Layout, Ink Save Mode, Thin Paper Copy, Remove Background and 2-sided Copy that you have changed to the factory default.

¹ MFC-J4610DW only.

- 1 Press  (Copy).
- 2 Press Options.
- 3 Press **^** or **v** on the Touchpanel to display Factory Reset.
- 4 Press Factory Reset.
- 5 Press Yes.
- 6 Press .

PhotoCapture Center™ operations

Memory cards, USB Flash memory drive and folder structures

Your machine is designed to be compatible with modern digital camera image files, memory cards and USB Flash memory drives; however, read the points below to avoid errors:

- The image file extension must be .JPG (other image file extensions like .JPEG, .TIF, .GIF and so on will not be recognised).
- Direct PhotoCapture Center™ printing must be performed separately from PhotoCapture Center™ operations using the PC. (Simultaneous operation is not available.)
- The machine can read up to 999 files ¹ on a memory card or USB Flash memory drive.
 - ¹ The folder inside memory cards or USB Flash memory drive is also counted.
- The DPOF file on the memory cards must be in a valid DPOF format. (See *DPOF printing* on page 48.)

Be aware of the following:

- When printing an index or image, the PhotoCapture Center™ will print all the valid images, even if one or more images have been corrupted. Corrupted images will not be printed.

■ (Memory card users)

Your machine is designed to read memory cards that have been formatted by a digital camera.

When a digital camera formats a memory card, it creates a special folder into which it copies image data. If you need to modify the image data stored on a memory card with your PC, we recommend that you do not modify the folder structure created by the digital camera. When saving new or modified image files to the memory card, we also recommend you use the same folder your digital camera uses. If the data is not saved to the same folder, the machine may not be able to read the file or print the image.

■ (USB Flash memory drive users)

This machine supports USB Flash memory drives that have been formatted by Windows®.

Movie printing

You can print images from movie files that are stored on a memory card or USB Flash memory drive.

Movie files are automatically split by duration into 9 parts, and placed in 3 rows so you can see and print the scenes.

NOTE

- You cannot choose a particular movie scene.
- You can use AVI or MOV movie file formats (Motion JPEG only). However, if an AVI file size is 1 GB or more (the shooting time is about 30 minutes) or a MOV file size is 2 GB or more (the shooting time is about 60 minutes), these files cannot be printed.
- If the data for a divided scene is corrupted, the part for that scene will be blank.

Print Images

Print Index (Thumbnails)

The PhotoCapture Center™ assigns numbers for images (such as No.1, No.2, No.3, and so on).



→ NO.1
DEI.JPG 01.01.2009
100KB

The PhotoCapture Center™ uses these numbers to identify each picture. You can print a thumbnail page to show all the pictures on the memory card or USB Flash memory drive.

NOTE

Only file names that are 20 characters or less will be printed correctly on the index sheet.

- 1 Open the media slot cover.
- 2 Put the memory card or USB Flash memory drive in the correct slot.
- 3 Press **▲** or **▼** on the Touchpanel to display `Index Print`.
- 4 Press `Index Print`.
- 5 Press `Index Sheet`.
- 6 Do one of the following:
 - Press `Options` to change the paper type or the paper size you are using. Go to step 7.
 - If you do not want to change the paper settings, press `Start` to print.

- 7 Press **Paper Type**. Press **▲** or **▼** to display the paper type you are using, and choose Plain Paper, Inkjet Paper, Brother BP71 or Other Glossy.
- 8 Press **Paper Size**.
- 9 Press **A4** or **Letter**.
- 10 Press **OK**.
- 11 Press **Start** to print.

Printing Photos

Before you can print an individual image, you have to know the image number.

- 1 Open the media slot cover.
- 2 Put the memory card or USB Flash memory drive in the correct slot.
- 3 Print the Index. (See *Print Index (Thumbnails)* on page 46.)
- 4 Press **▲** or **▼** to display  (Photo) and press it.
- 5 Press **▲** or **▼** on the Touchpanel to display **Index Print**.
- 6 Press **Index Print**.
- 7 Press **Print Photos**.
- 8 Enter the image number that you want to print from the thumbnails printed on the Index page. After you have chosen the image numbers, press **OK**.

- 9 Press **OK**.

NOTE

- You can enter multiple numbers at the same time by using a comma or hyphen to separate them. For example, Enter 1,3,6 to print images No.1, No.3 and No.6. Enter 1-5 to print images No.1 to No.5.
- You can enter up to 12 characters (including commas and hyphens) for the image numbers you want to print.

- 10 Do one of the following:
 - Press **Options** to change the print settings. (See page 48.)
 - If you do not want to change any settings, press **Start** to print.

Printing All Photos

You can print all the photos on your memory card or USB Flash memory drive.

- 1 Open the media slot cover.
- 2 Put the memory card or USB Flash memory drive in the correct slot.
- 3 Press **▲** or **▼** on the Touchpanel to display **Print All**.
- 4 Press **Print All**.
- 5 Do one of the following:
 - Press **Options** to change the print settings. (See page 48.)
 - If you do not want to change any settings, press **Start** to print.

DPOF printing

DPOF stands for Digital Print Order Format.

Major digital camera manufacturers (Canon Inc., Eastman Kodak Company, FUJIFILM Corporation, Panasonic Corporation and Sony Corporation) created this standard to make it easier to print images from a digital camera.

If your digital camera supports DPOF printing, you will be able to choose the images and the number of copies you want to print on the display of the digital camera.

When a memory card containing DPOF information is put into your machine, you can print the chosen image easily.

- 1 Open the media slot cover.
- 2 Put the memory card or USB Flash memory drive in the correct slot.
The machine will ask you if you want to use DPOF settings.
The DPOF file on the memory card or USB Flash memory drive must be in a valid DPOF format.
- 3 Press **Yes**.
- 4 Do one of the following:
 - Press **Options** to change the print settings. (See page 48.)
 - If you do not want to change any settings, press **Start** to print.

NOTE

A DPOF File error can occur if the print order that was created on the camera has been corrupted. Delete and recreate the print order using your camera to correct this problem. For instructions on how to delete or recreate the print order, refer to your camera manufacturer's support website or accompanying documentation.

PhotoCapture Center™ print settings

You can change the print settings temporarily for the next print job.

The machine returns to its default settings after being idle for one minute.

NOTE

You can save the print settings you use most often by setting them as the default. (See *Setting your changes as a new default* on page 53.)



Print Quality

- 1 Open the media slot cover.
- 2 Put the memory card or USB Flash memory drive in the correct slot.
- 3 Do one of the following:
 - Press **View Photos** and press **^** or **v** on the Touchpanel to display each photo. When the photo you want to print is displayed, press **OK**.
 - Press **Print All**.
- 4 Press **Options**.
- 5 Press **^** or **v** to display **Print Quality**.
- 6 Press **Print Quality**.
- 7 Press **Normal** or **Photo**.
- 8 If you do not want to change additional settings, press **↩** or **OK**.
- 9 Press **Start** to print.

Paper options

Paper Type

- 1 Open the media slot cover.
- 2 Put the memory card or USB Flash memory drive in the correct slot.
- 3 Do one of the following:
 - Press `View Photos` and press `▲` or `▼` on the Touchpanel to display each photo. When the photo you want to print is displayed, press `OK`.
 - Press `Print All`.
- 4 Press `Options`.
- 5 Press `▲` or `▼` to display `Paper Type`.
- 6 Press `Paper Type`.
- 7 Press `▲` or `▼` to display `Plain Paper`, `Inkjet Paper`, `Brother BP71` or `Other Glossy`. Press the option you want to set.
- 8 If you do not want to change additional settings, press `↩` or `OK`.
- 9 Press `Start` to print.







Paper Size and Print Size

- 1 Open the media slot cover.
- 2 Put the memory card or USB Flash memory drive in the correct slot.
- 3 Do one of the following:
 - Press `View Photos` and press `▲` or `▼` on the Touchpanel to display each photo. When the photo you want to print is displayed, press `OK`.
 - Press `Print All`.
- 4 Press `Options`.

- 5 Press `▲` or `▼` to display `Paper Size`.
- 6 Press `Paper Size`.
- 7 Press `▲` or `▼` to display `10x15cm`, `13x18cm`, `A4`, `A3`, `Letter` or `Ledger`. Press the option you want to set. Do one of the following:
 - If you chose `A4` or `Letter`, go to step 8.
 - If you chose `10x15cm` or `13x18cm`, go to step 9.
 - If you chose `A3` or `Ledger`, the Touchscreen will prompt you to put the paper in manual feed slot. Read the information on the Touchscreen, and then confirm it by pressing `OK`. (See *Basic User's Guide: Loading paper in the manual feed slot.*) Go to step 9.

- 8 Press the `Print Size`.

Example: Printed position for A4 size paper

1	2	3
8x10cm	9x13cm	10x15cm
		
4	5	6
13x18cm	15x20cm	Max. Size
		

- 9 If you do not want to change additional settings, press `↩` or `OK`.
- 10 Press `Start` to print.

Adjusting Brightness, Contrast and Colour

Brightness

- 1 Open the media slot cover.
- 2 Put the memory card or USB Flash memory drive in the correct slot.
- 3 Do one of the following:
 - Press `View Photos` and press `▲` or `▼` on the Touchpanel to display each photo. When the photo you want to print is displayed, press `OK`.
 - Press `Print All`.
- 4 Press `Options`.
- 5 Press `▲` or `▼` to display `Brightness`.
- 6 Press `Brightness`.
- 7 Press `◀` or `▶` to make the print darker or lighter.
Press `OK`.
- 8 If you do not want to change additional settings, press `↩` or `OK`.
- 9 Press `Start` to print.

Contrast

You can choose the contrast setting. Increasing the contrast will make an image look sharper and more vivid.

- 1 Open the media slot cover.
- 2 Put the memory card or USB Flash memory drive in the correct slot.
- 3 Do one of the following:
 - Press `View Photos` and press `▲` or `▼` on the Touchpanel to display each photo. When the photo you want to print is displayed, press `OK`.
 - Press `Print All`.
- 4 Press `Options`.
- 5 Press `▲` or `▼` to display `Contrast`.
- 6 Press `Contrast`.
- 7 Press `◀` or `▶` to change the contrast.
Press `OK`.
- 8 If you do not want to change additional settings, press `↩` or `OK`.
- 9 Press `Start` to print.

Colour Enhancement

You can turn on the colour enhancement feature to print more vivid images. Printing time will be slower with this feature and depending on the image you are printing, it may use more ink.

- 1 Open the media slot cover.
- 2 Put the memory card or USB Flash memory drive in the correct slot.
- 3 Do one of the following:
 - Press `View Photos` and press `▲` or `▼` on the Touchpanel to display each photo. When the photo you want to print is displayed, press `OK`.
 - Press `Print All`.
- 4 Press `Options`.
- 5 Press `▲` or `▼` to display `Colour Enhance`.
- 6 Press `Colour Enhance`.
- 7 Do one of the following:
 - If you want to adjust the `White Balance`, `Sharpness` or `Colour Density`, press `Colour Enhance` and then press `On`.
Go to step 8.
 - If you do not want to adjust the colour settings, press `Colour Enhance` and then press `Off`.
Press `↩`.
Go to step 11.
- 8 Press `▲` or `▼` to display `White Balance`, `Sharpness` or `Colour Density`, and then press the option you want to change.
- 9 Press `◀` or `▶` to adjust the degree of the setting.
Press `OK`.

- 10 Do one of the following:
 - If you want to adjust another colour setting, repeat steps 8 and 9.
Press `↩`.
 - If you want to change other settings, press `↩` to display the print setting menu and press the setting you want to change. (See page 48.)
- 11 If you do not want to change additional settings, press `↩` or `OK`.
- 12 Press `Start` to print.

NOTE

• White Balance

This setting adjusts the hue of the white areas of an image. Lighting, camera settings and other influences will affect the appearance of white. The white areas of a picture may be slightly pink, yellow or some other colour. By using this setting, you can correct that effect and bring the white areas back to pure white.

• Sharpness

This setting enhances the detail of an image, similar to adjusting the fine focus on a camera. If the image is not in true focus and you cannot see the fine details of the picture, then adjust the sharpness.

• Colour Density

This setting adjusts the total amount of colour in the image. You can increase or decrease the amount of colour in an image to improve a washed out or weak picture.

Cropping

If your photo is too long or too wide to fit the available space on your chosen layout, part of the image will automatically be cropped.

The default setting is *On*. If you want to print the whole image, turn this setting to *Off*. If you set *Cropping* to *Off*, also set *Borderless* to *Off*. (See *Borderless printing* on page 52.)

- 1 Open the media slot cover.
- 2 Put the memory card or USB Flash memory drive in the correct slot.
- 3 Do one of the following:
 - Press *View Photos* and press \blacktriangle or \blacktriangledown on the Touchpanel to display each photo. When the photo you want to print is displayed, press *OK*.
 - Press *Print All*.
- 4 Press *Options*.
- 5 Press \blacktriangle or \blacktriangledown to display *Cropping*.
- 6 Press *Cropping*.
- 7 Press *Off* (or *On*).
- 8 If you do not want to change additional settings, press \blackrightarrow or *OK*.
- 9 Press *Start* to print.

Cropping: On

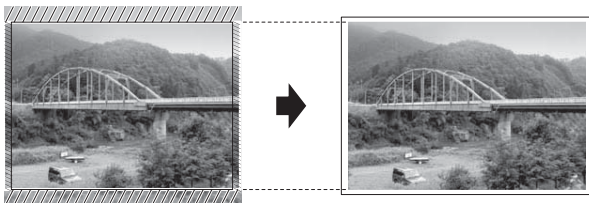

Cropping: Off

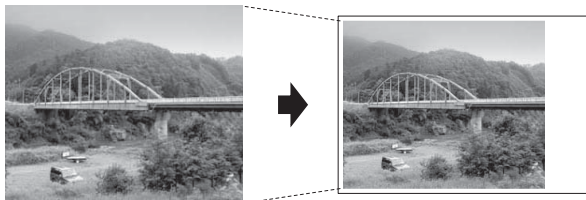

Borderless printing

This feature expands the printable area to the edges of the paper. Printing time will be slightly slower.

- 1 Open the media slot cover.
- 2 Put the memory card or USB Flash memory drive in the correct slot.
- 3 Do one of the following:
 - Press *View Photos* and press \blacktriangle or \blacktriangledown on the Touchpanel to display each photo. When the photo you want to print is displayed, press *OK*.
 - Press *Print All*.
- 4 Press *Options*.
- 5 Press \blacktriangle or \blacktriangledown to display *Borderless*.
- 6 Press *Borderless*.
- 7 Press *Off* (or *On*).
- 8 If you do not want to change additional settings, press \blackrightarrow or *OK*.
- 9 Press *Start* to print.

Date Print

You can print the date if it is already in the data on your photo. The date will be printed on the lower-right corner. If the data does not have the date information, you cannot use this function.

- 1 Open the media slot cover.
- 2 Put the memory card or USB Flash memory drive in the correct slot.
- 3 Do one of the following:
 - Press `View Photos` and press `▲` or `▼` on the Touchpanel to display each photo. When the photo you want to print is displayed, press `OK`.
 - Press `Print All`.
- 4 Press `Options`.
- 5 Press `▲` or `▼` to display `Date Print`.
- 6 Press `Date Print`.
- 7 Press `On` (or `Off`).
- 8 If you do not want to change additional settings, press `↩` or `OK`.
- 9 Press `Start` to print.

NOTE

The DPOF setting on your camera must be turned off to use the `Date Print` feature.

Setting your changes as a new default

You can save the print settings you use most often by setting them as the default settings, such as `Print Quality`, `Paper Type`, `Paper Size`, `Brightness`, `Contrast`, `Colour Enhance`, `Cropping`, `Borderless` and `Date Print`. These settings will remain until you change them again.

- 1 Open the media slot cover.
- 2 Put the memory card or USB Flash memory drive in the correct slot.
- 3 Do one of the following:
 - Press `View Photos` and press `▲` or `▼` on the Touchpanel to display each photo. When the photo you want to print is displayed, press `OK`.
 - Press `Print All`.
- 4 Press `Options`.
- 5 Press your new setting. Repeat this step for each setting you want to change.
- 6 After changing the last setting, press `▲` or `▼` to choose `Set New Default`.
- 7 Press `Set New Default`.
- 8 Press `OK`. The Touchscreen asks you again to confirm if you want to set the changes as the new default settings. Press `Yes`.
- 9 Press `Home`.

Restoring all settings to the factory default



You can restore the PhotoCapture settings you have changed back to the factory default for, Print Quality, Paper Type, Paper Size, Brightness, Contrast, Colour Enhance, Cropping, Borderless and Date Print.

- 1 Open the media slot cover.
- 2 Put the memory card or USB Flash memory drive in the correct slot.
- 3 Do one of the following:
 - Press **View Photos** and press **▲** or **▼** on the Touchpanel to display each photo. When the photo you want to print is displayed, press **OK**.
 - Press **Print All**.
- 4 Press **Options**.
- 5 Press **▲** or **▼** to display **Factory Reset**.
- 6 Press **Factory Reset**.
- 7 The Touchscreen asks you to confirm to change back to the factory default. Press **Yes** to confirm.
- 8 Press .

Scan to a memory card or USB Flash memory drive

How to set a new default

You can save the Scan to Media settings (Scan Type, Resolution, File Type and Remove Background) you use most often by setting them as the default settings. These settings will remain until you change them again.

- 1 Open the media slot cover.
- 2 Put the memory card or USB Flash memory drive in the correct slot.
- 3 Press .
- 4 Press  (Scan).
- 5 Press **▲** or **▼** on the Touchpanel to display **Scan to Media**.
- 6 Press **Scan to Media**.
- 7 Press **Options**.
- 8 Press **Scan Type**, **Resolution**, **File Type** or **Remove Background**. Then press the option you want to change. Repeat this step for each setting you want to change.
- 9 After you have finished choosing your preferred settings, press **▲** or **▼** to display **Set New Default**.
- 10 Press **Set New Default**.
- 11 Press **OK**. The Touchscreen asks you again to confirm if you want to set the change as the new default. Press **Yes**.
- 12 Press .

How to reset to the factory default

You can restore all of the Scan to Media settings (Scan Type, Resolution, File Type and Remove Background) that you have changed to the factory default.

- 1 Open the media slot cover.
- 2 Put the memory card or USB Flash memory drive in the correct slot.
- 3 Press .
- 4 Press  (Scan).
- 5 Press  or  on the Touchpanel to display Scan to Media.
- 6 Press Scan to Media.
- 7 Press Options.
- 8 Press  or  to display Factory Reset.
- 9 Press Factory Reset.
- 10 The Touchscreen asks you to confirm to change back to the factory default. Press Yes to confirm.
- 11 Press .

Printing photos directly from a PictBridge camera



Your Brother machine supports the PictBridge standard, allowing you to connect to and print photos directly from any PictBridge compatible digital camera.

If your camera is using the USB Mass Storage standard, you can also print photos from a digital camera without PictBridge. (See *Printing photos directly from a digital camera (without PictBridge)* on page 58.)

PictBridge requirements

To avoid errors, remember the following points:

- The machine and the digital camera must be connected using a suitable USB cable.
- The image file extension must be .JPG (other image file extensions like .JPEG, .TIF, .GIF and so on will not be recognised).
- PhotoCapture Center™ operations are not available when using the PictBridge feature.

Setting your digital camera

Make sure your camera is in PictBridge mode. The following PictBridge settings may be available from the LCD of your PictBridge compatible camera.

Depending on your camera, some of these settings may not be available.

Camera Menu Selections	Options
Paper Size	A3, A4, Ledger, Letter, 10 x 15 cm, Printer Settings (Default setting) ²
Paper Type	Plain Paper, Glossy Paper, Inkjet Paper, Printer Settings (Default setting) ²
Layout	Borderless: On, Borderless: Off, Printer Settings (Default setting) ²
DPOF Setting ¹	-
Print Quality	Normal, Fine, Printer Settings (Default setting) ²
Colour Enhancement	On, Off, Printer Settings (Default setting) ²
Date Print	On, Off, Printer Settings (Default setting) ²

¹ See *DPOF printing* on page 58 for more information.

² If your camera is set to use the Printer Settings (Default setting), the machine will print your photo using the following settings.

Settings	Options
Paper Size	10 × 15 cm
Paper Type	Other Glossy
Layout	Borderless: On
Print Quality	Photo
Colour Enhancement	Off
Date Print	Off

- When your camera does not have any menu selections, these settings are also used.
- The name and availability of each setting depends on the specification of your camera.

See the documentation supplied with your camera for more detailed information on changing PictBridge settings.

Printing Images

NOTE

Remove any memory cards or USB Flash memory drives from the machine before connecting a digital camera.

- 1 Open the media slot cover.
- 2 Make sure that your camera is turned off. Connect your camera to the USB direct interface (1) on the machine using the USB cable.

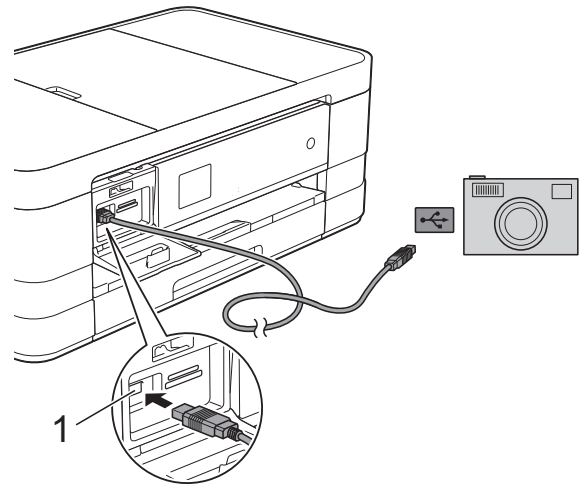

1 USB direct interface

- 3 Turn on the camera.
When the machine has recognised the camera, the Touchscreen shows `Camera Connected`.
- 4 Choose the photo you want to print, following the instructions from your camera.
When the machine starts printing a photo, the Touchscreen will show `Printing`.

IMPORTANT

To prevent damage to your machine, do not connect any device other than a digital camera or USB Flash memory drive to the USB direct interface.

DPOF printing

DPOF stands for Digital Print Order Format.

Major digital camera manufacturers (Canon Inc., Eastman Kodak Company, FUJIFILM Corporation, Panasonic Corporation and Sony Corporation) created this standard to make it easier to print images from a digital camera.

If your digital camera supports DPOF printing, you will be able to choose the images and the number of copies you want to print on the display of the digital camera.

NOTE

A DPOF File error can occur if the print order that was created on the camera has been corrupted. Delete and recreate the print order using your camera to correct this problem. For instructions on how to delete or recreate the print order, refer to your camera manufacturer's support website or accompanying documentation.

Printing photos directly from a digital camera (without PictBridge)

If your camera supports the USB Mass Storage standard, you can connect your camera in storage mode. This enables you to print photos from your camera.

(If you would like to print photos in PictBridge mode, see *Printing photos directly from a PictBridge camera* on page 56.)

NOTE

The name, availability and operation differ among digital cameras. See the documentation supplied with your camera for detailed information, such as how to switch from PictBridge mode to USB mass storage mode.

Printing Images

NOTE

Remove any memory cards or USB Flash memory drives from the machine before connecting a digital camera.

- 1 Open the media slot cover.
- 2 Make sure that your camera is turned off. Connect your camera to the USB direct interface (1) on the machine using the USB cable.

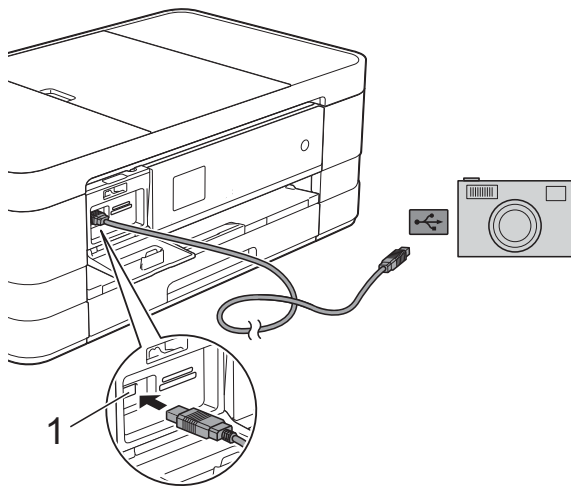

1 USB direct interface

- 3 Turn on the camera.
- 4 Follow the steps in *Print Images* on page 46.

IMPORTANT

To prevent damage to your machine, do not connect any device other than a digital camera or USB Flash memory drive to the USB direct interface.

A

Routine maintenance

Cleaning and checking the machine

Cleaning the outside of the machine

Clean the Touchscreen as follows:

IMPORTANT

- Unplug the machine from the electrical socket when cleaning the Touchscreen.
- DO NOT use any type of liquid cleaners (including ethanol).

- 1 Clean the Touchscreen with a *dry*, soft lint-free cloth.

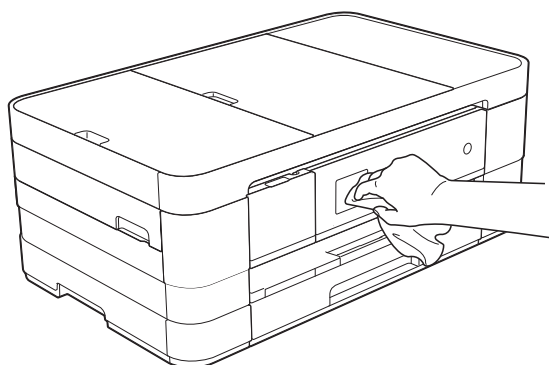

Clean the outside of the machine as follows:

IMPORTANT

- Use neutral detergents. Cleaning with volatile liquids such as thinner or benzine will damage the outside surface of the machine.
- DO NOT use cleaning materials that contain ammonia.
- DO NOT use isopropyl alcohol to remove dirt from the control panel. It may crack the panel.

- 1 (MFC-J2310, MFC-J4410DW and DCP-J4110DW)
Pull the paper tray (1) completely out of the machine.

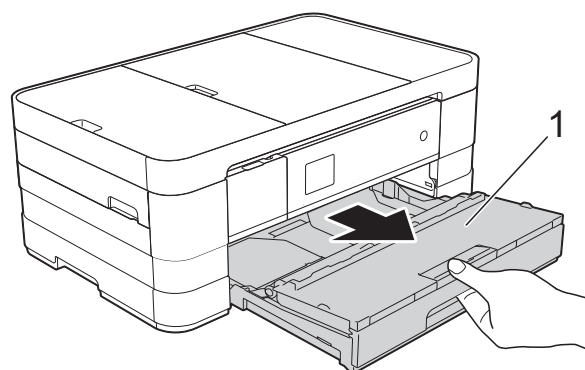

- (MFC-J4610DW)
Pull paper tray #1 and then tray #2 completely out of the machine.

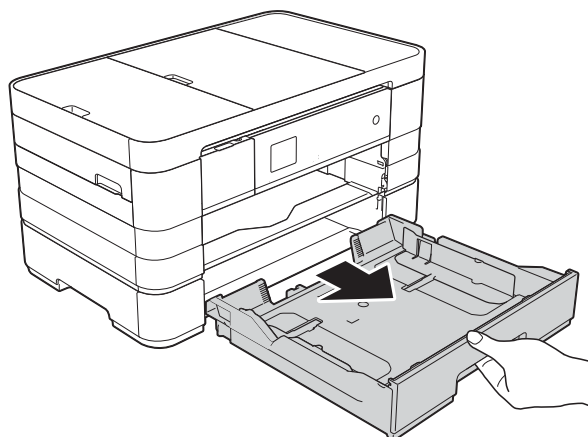

- Wipe the outside of the machine with a *dry*, soft lint-free cloth to remove dust.

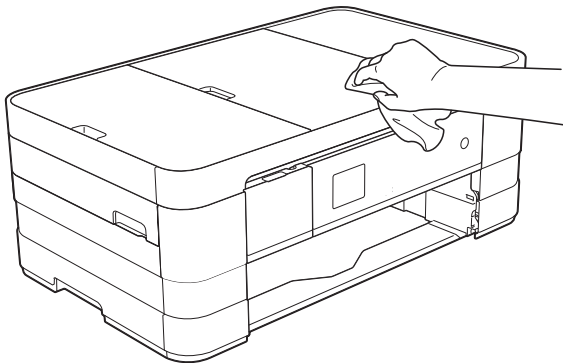

- Lift the output paper tray cover and remove anything that is stuck inside the paper tray.
- Wipe the inside and outside of the paper tray with a *dry*, soft lint-free cloth to remove dust.

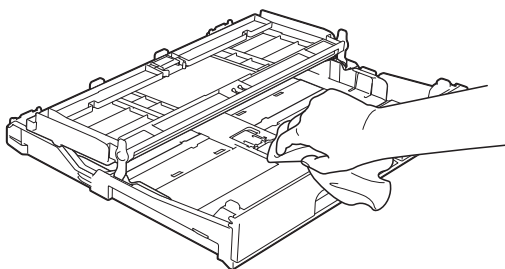

- Close the output paper tray cover and put the paper tray firmly back in the machine.

Cleaning the machine's printer platen

! WARNING



Be sure to unplug the machine from the electrical socket before cleaning the printer platen to avoid an electrical shock.

- Using both hands, use the finger holds on each side of the machine to lift the scanner cover into the open position.
- Clean the machine's printer platen (1) and the area around it, wiping off any scattered ink with a soft, *dry* lint-free cloth.

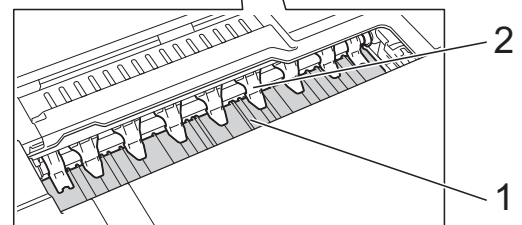
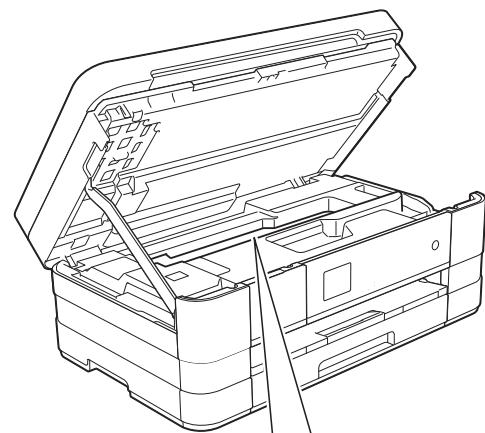

IMPORTANT

DO NOT bend or apply too much pressure on the nine tabs (2). This may cause damage.

3 Lift the scanner cover to release the lock. Gently push the scanner cover support down and close the scanner cover using both hands.

4 Re-connect the power cord.

Cleaning the paper feed rollers

If the paper feed rollers are stained with ink, it may cause paper feed problems.

1 Unplug the machine from the electrical socket. Pull the paper tray (1) completely out of the machine.

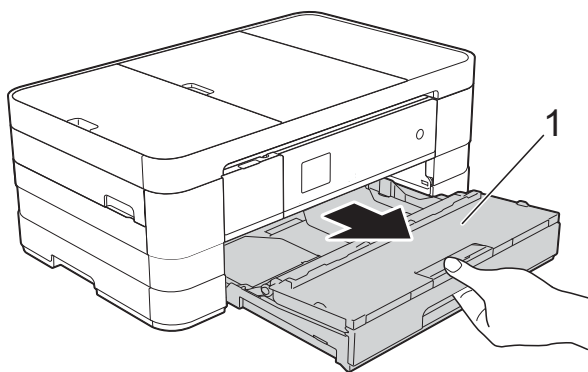

NOTE

If the paper support flap is open, close it, and then close the paper support.

2 Clean the front side of the Paper Feed Rollers (1) with a soft lint-free cloth slightly moistened with water, using a side-to-side motion.

After cleaning, wipe the rollers with a *dry*, soft lint-free cloth to remove all moisture.

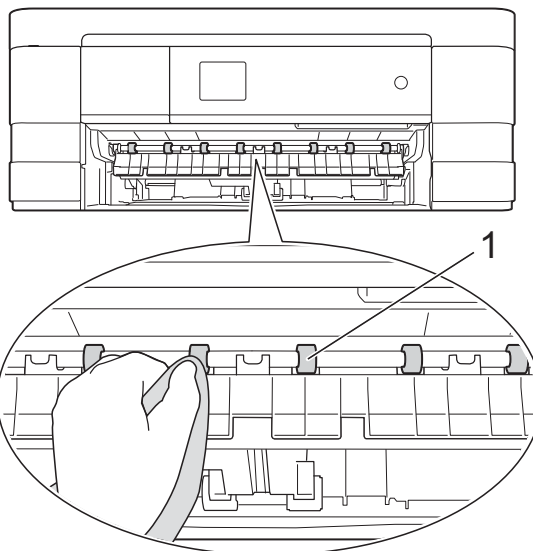

3 Lift the Jam Clear Flap (2), and then clean the back side of the Paper Feed Rollers (1) with a soft lint-free cloth slightly moistened with water.

After cleaning, wipe the rollers with a *dry*, soft lint-free cloth to remove all moisture.

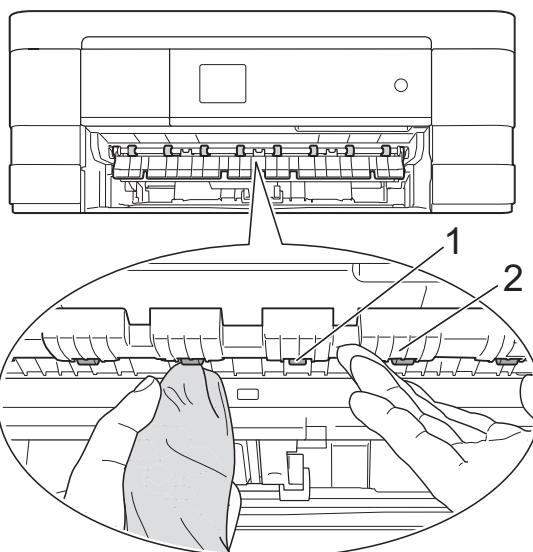

- 4 Put the paper tray firmly back in the machine.
- 5 Re-connect the power cord.

NOTE

Do not use the machine again until the rollers are completely dry. Using the machine before the rollers are dry may cause paper feed problems.

Cleaning the paper pick-up rollers

- 1 Unplug the machine from the electrical socket.
- 2 Pull the paper tray completely out of the machine.

NOTE

If the machine starts to multi-feed the last few sheets of paper in the tray, clean the Base Pad (1) with a soft lint-free cloth slightly moistened with water.

After cleaning, wipe the pad with a *dry*, soft lint-free cloth to remove all moisture.

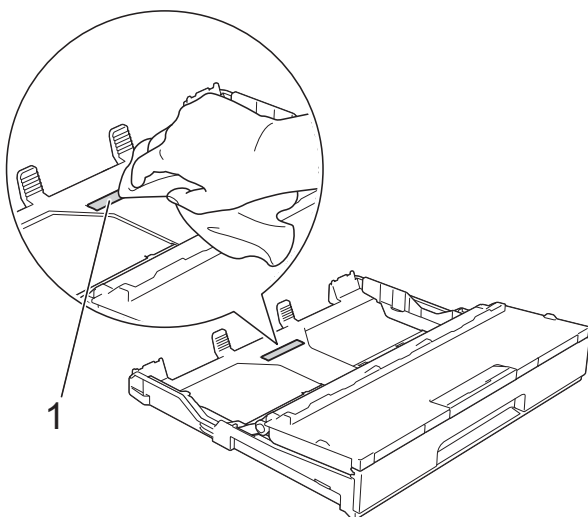

- 3 Clean the Paper Pick-up Rollers (1) with a soft lint-free cloth slightly moistened with water. Slowly turn the rollers so that the whole surface is cleaned. After cleaning, wipe the rollers with a *dry*, soft lint-free cloth to remove all moisture.

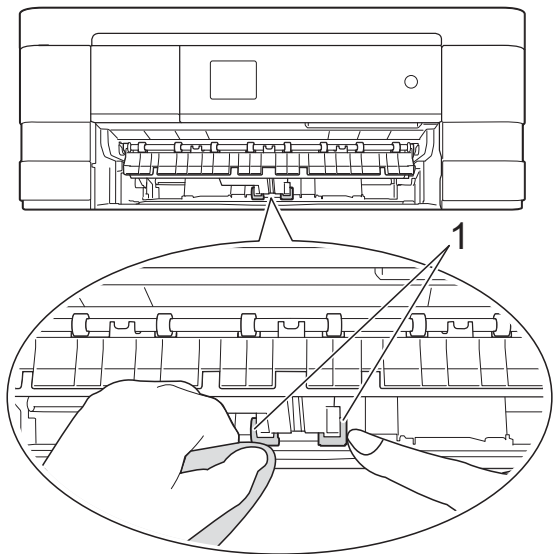

- 4 Put the paper tray firmly back in the machine.
- 5 Re-connect the power cord.

Cleaning the paper pick-up rollers for paper tray #2 (MFC-J4610DW)

- 1 Unplug the machine from the AC power outlet. Pull tray #2 completely out of the machine.

NOTE

If the paper support flap is open, close it, and then close the paper support.

- 2 Clean the paper pick-up rollers for tray #2 (1) with a soft lint-free cloth moistened with water. Slowly turn the rollers so that the whole surface is cleaned. After cleaning, wipe the rollers with a dry, soft lint-free cloth to remove all moisture.

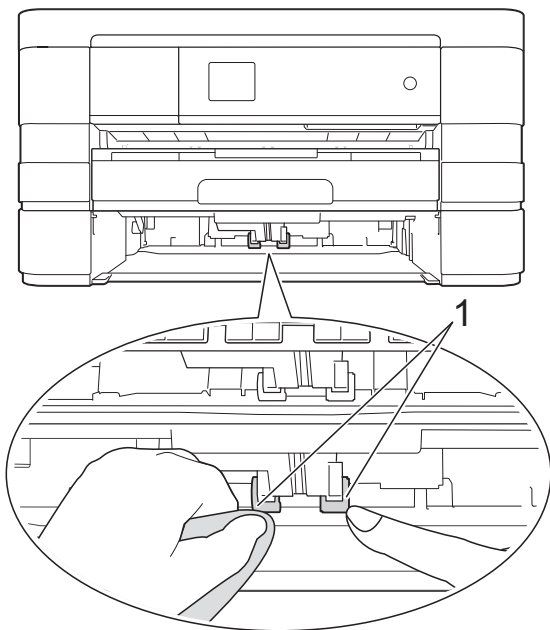

- 3 Put tray #2 firmly back in the machine.
- 4 Re-connect the power cord.

Checking the ink volume

You can use the ink menu to see a large graph showing the ink that is left in each cartridge.

- 1 Press  (Settings).

NOTE

If  is on the Touchscreen, you can press it, and then go to step 5.

- 2 Press **^** or **v** on the Touchpanel to display *General Setup*.
- 3 Press *General Setup*.
- 4 Press *Ink*.
- 5 Press **^** or **v** to display *Ink Volume*.
- 6 Press *Ink Volume*.
The Touchscreen shows the ink volume.
- 7 Press .

NOTE

You can check the ink volume from your computer.
(See *Software User's Guide: Printing (Windows®)*.)
(See *Software User's Guide: Printing and Faxing (Macintosh)*.)

Packing and shipping the machine

When you transport the machine, use the packing materials that came with your machine. Follow the instructions below to correctly package your machine. Damage caused to your machine during transit may not be covered by your warranty.

The machine should be adequately insured with the carrier.

IMPORTANT

It is important to allow the machine to “park” the print head after a print job. Listen carefully to the machine before unplugging it to make sure that all mechanical noises have stopped. Not allowing the machine to finish this process may lead to print problems and possible damage to the print head.

- 1 Unplug the machine from the electrical socket.
- 2 Using both hands, use the finger holds on each side of the machine to lift the scanner cover into the open position. Then unplug the machine from the telephone wall socket and take the telephone line cord out of the machine.
- 3 Unplug the interface cable from the machine, if it is connected.

- 4 Lift the scanner cover (1) to release the lock. Gently push the scanner cover support down (2) and close the scanner cover (3) using both hands.

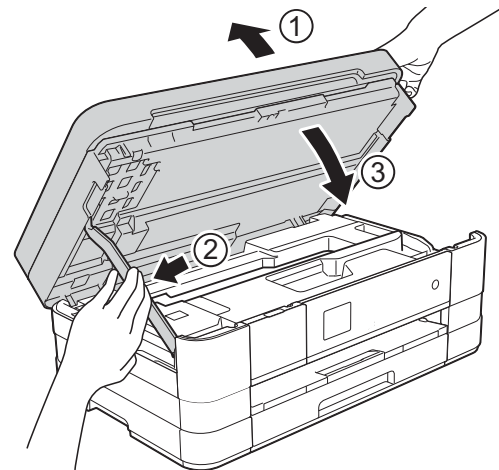

- 5 Open the ink cartridge cover.
- 6 Remove all four ink cartridges. Press the ink release lever above each cartridge to release it. (See Basic User's Guide: *Replacing the ink cartridges*.)
- 7 Install the orange protective part and then close the ink cartridge cover.

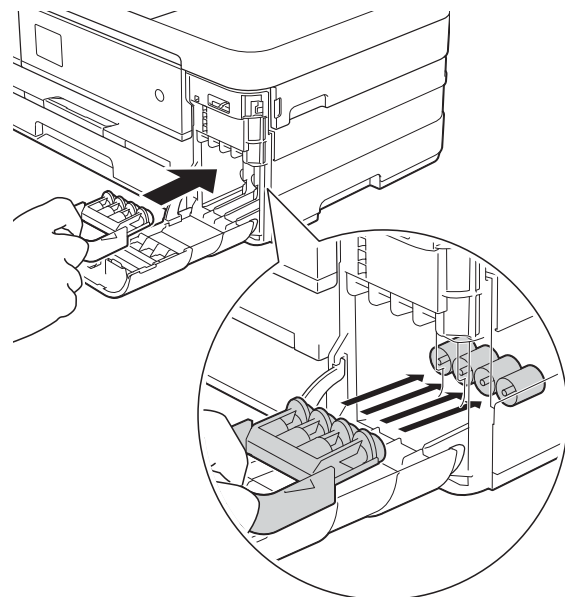

IMPORTANT

- Make sure the plastic tab on the left side of the orange protective part (1) clicks securely into place (2).

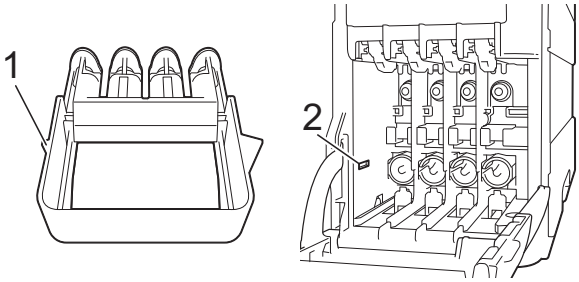

- If you are not able to find the orange protective part, ship the machine without it. DO NOT install the ink cartridges as an alternative before shipping.

- 8 Wrap the machine in the bag.

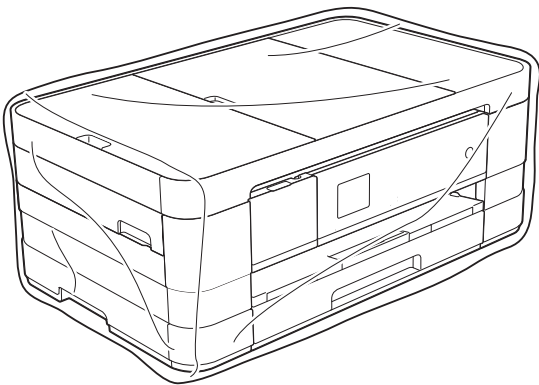

- 9 Pack the machine and the printed materials in the original carton with the original packing material as shown below.

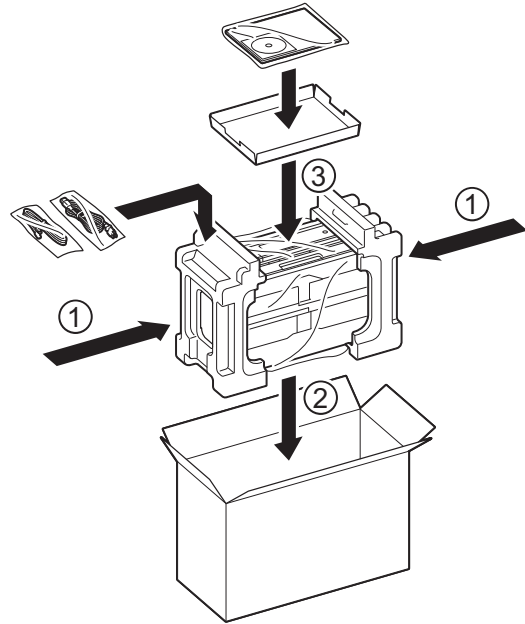

- 10 Close the carton and tape it shut.

B

Glossary

This is a comprehensive list of features and terms that appear in Brother manuals. Availability of these features depends on the model you purchased.

1.8" Touchscreen LCD and Touchpanel

The Touchscreen LCD (Liquid Crystal Display) on the machine shows interactive messages and prompts for using the machine. You can operate the Touchscreen by pressing the screen. The Touchpanel on the right side of the Touchscreen illuminates its LEDs when they are available for the current operation.

Address Book

Your list of Speed Dial names and numbers that you have stored for easy dialling.

ADF (automatic document feeder)

The document can be placed in the ADF and scanned one page at a time automatically.

Auto Reduction

Reduces the size of incoming faxes.

Automatic fax transmission

Sending a fax without picking up the handset of an external telephone.

Automatic Redial

A feature that enables your machine to redial the last fax number after five minutes if the fax did not go through because the line was busy.

Backup Print

Your machine prints a copy of every fax that is received and stored in its memory. This is a safety feature so you will not lose messages during a power failure.

Batch Transmission

(Monochrome faxes only) As a cost-saving feature, all delayed faxes to the same fax number can be sent as one transmission.

Beeper Volume

Volume setting for the beep when you press a key or make an error.

Brightness

Changing the Brightness makes the whole image lighter or darker.

Broadcasting

The ability to send the same fax message to more than one location.

Caller ID

A service purchased from the telephone company that lets you see the number (or name) of the party calling you.

CNG tones

The special tones (beeps) sent by fax machines during automatic transmission to tell the receiving machine that a fax machine is calling.

Coding method

Method of coding the information contained in the document. All fax machines must use a minimum standard of Modified Huffman (MH). Your machine is capable of greater compression methods (Modified Read (MR), Modified Modified Read (MMR) and JPEG) if the receiving machine has the same capability.

Colour Enhancement

Adjusts the colour in the image for better print quality by improving sharpness, white balance and colour density.

Communication error (Comm. Error)

An error during fax sending or receiving, usually caused by line noise or static.

Compatibility group

The ability of one fax unit to communicate with another. Compatibility is assured between ITU-T Groups.

Contrast

Setting to compensate for dark or light documents by making faxes or copies of dark documents lighter and light documents darker.

Delayed Fax

Sends your fax at a specified time later.

Density

Changing the Density makes the whole image lighter or darker.

Distinctive Ring (Not available in New Zealand and Taiwan)

A subscriber service purchased from the telephone company that gives you another telephone number on an existing telephone line. The Brother machine uses the new number to simulate a dedicated fax line.

Dual Access

Your machine can scan outgoing faxes or scheduled jobs into the memory at the same time it is sending a fax from memory or receiving or printing an incoming fax.

ECM (Error Correction Mode)

Detects errors during fax transmission and resends the pages of the fax that had an error.

Extension telephone

A telephone using the same line as your fax but plugged into a separate wall socket.

External telephone

A TAD (telephone answering device) or telephone that is connected to your machine.

F/T Ring Time

The length of time that the Brother machine rings (when the Receive Mode setting is Fax/Tel) to notify you to pick up a voice call that it answered.

FaxAbility (New Zealand only)

A subscriber service purchased from the telephone company that provides another phone number on an existing phone line. The Brother fax machine uses the new number to simulate a dedicated fax line.

Fax Detect

Enables your machine to respond to CNG tones if you interrupt a fax call by answering it.

Fax Forwarding

Sends a fax received into the memory to another pre-programmed fax number.

Fax Journal

Lists information about the last 200 incoming and outgoing faxes. TX means Transmit. RX means Receive.

Fax Storage

You can store received faxes in memory.

Fax tones

The signals sent by sending and receiving fax machines while communicating information.

Fax/Tel

You can receive faxes and telephone calls. Do not use this mode if you are using a telephone answering device (TAD).

Fine resolution

Resolution is 203 × 196 dpi. It is used for small print and graphs.

Greyscale

The shades of grey available for copying, scanning and faxing photographs.

Group number

A combination of Speed Dial numbers that are stored in a Speed Dial location for Broadcasting.

Innobella™

Innobella™ is a range of genuine consumables offered by Brother. For best quality results, Brother recommends Innobella™ ink and paper.

Journal Period

The pre-programmed time period between automatically printed Fax Journal reports. You can print the Fax Journal report on demand without interrupting the cycle.

Manual fax

You can press **Hook** to hear the receiving fax machine answer before you press **Fax Start** to begin sending the fax.

Memory Receive

Receives faxes into the machine's memory when the machine is out of paper.

Settings Tables

At-a-glance instructions that show all the available settings and options available for setting up your machine.

OCR (optical character recognition)

Nuance™ PaperPort™ 12SE or Presto! PageManager software application converts an image of text to text you can edit.

Overseas Mode

Makes temporary changes to the fax tones to accommodate noise and static on overseas telephone lines.

Pause

Allows you to place a 3.5 second delay in the dialling sequence while you are dialling using the dial pad or while you are storing Speed Dial numbers. Press the **Pause** on the Touchscreen as many times as needed for longer pauses.

PhotoCapture Center™

Allows you to print digital photos from your digital camera at high resolution for photo quality printing.

Photo resolution (Mono only)

A resolution setting that uses varying shades of grey for the best representation of photographs.

PictBridge

Allows you to print photos directly from your digital camera at high resolution for photo quality printing.

Polling

The process of a fax machine calling another fax machine to retrieve waiting fax messages.

Pulse (Not available in New Zealand)

A form of rotary dialling on a telephone line.

Quick Dial List

A listing of names and numbers stored in Address Book memory, in numerical order.

Real Time Transmission

When the memory is full, you can send faxes in real time.

Remaining jobs

You can check which jobs are waiting in memory and cancel jobs individually.

Remote Access Code

Your own four-digit code (---*) that allows you to call and access your machine from a remote location.

Remote Activation Code

Press this code (* 5 1 (* 9 1 for New Zealand)) when you answer a fax call on an extension or external telephone.

Remote Deactivation Code (For Fax/Tel mode only)

When the machine answers a voice call, it fast double-rings. You can pick up at an extension telephone by pressing this code (# 5 1 (# 9 1 for New Zealand)).

Remote Retrieval Access

The ability to access your machine remotely from a touch-tone telephone.

Resolution

The number of vertical and horizontal lines per inch. See: Standard, Fine, Super Fine and Photo.

Ring Delay

The number of rings before the machine answers in **Fax Only** and **Fax/Tel** modes.

Ring Volume

Volume setting for the machine's ring.

Scanning

The process of sending an electronic image of a paper document to your computer.

Scan to Media

You can scan a monochrome or colour document on to a memory card or USB Flash memory drive. Monochrome images will be in the TIFF or PDF file format and colour images may be in the PDF or JPEG file format.

Search

A numerical or alphabetical electronic listing of stored Speed Dial and Group numbers.

Speed Dial

You can set up names and numbers for easy dialling.

Standard resolution

203 × 98 dpi (monochrome).
203 × 196 dpi (colour). It is used for regular sized text and the quickest transmission.

Station ID

The stored information that appears on the top of faxed pages. It includes the sender's name and fax number.

Super Fine resolution (Mono only)

203 × 392 dpi. Best for very small print and line art.

TAD (telephone answering device)

You can connect an external TAD to your machine.

Temporary settings

You can choose certain options for each fax transmission and copy without changing the default settings.

Tone (Not available in New Zealand)

A form of dialling on the telephone line used for touch-tone telephones.

Transmission

The process of sending faxes over the phone lines from your machine to the receiving fax machine.

Transmission Verification Report

A listing for each fax sent that shows its date, time and number.

User Settings

A printed report that shows the current settings of the machine.

WLAN Report

A printed report that shows the result of the WLAN Connection.

Numerics

2 in 1 ID Copy	38
2-sided	
copy	42

A

Access codes, storing and dialling	28
Address Book	
Broadcasting	12
deleting Groups	32
using Groups	12
Group dial	
changing	31
setting up Groups for Broadcasting ...	31
setting up from Caller ID history	30
setting up from outgoing calls	29
Speed Dial	
setting up from Caller ID history	30
setting up from outgoing calls	29
Apple Macintosh	
See Software User's Guide.	

B

Broadcasting	12
setting up Groups for	31

C

Caller ID	
Caller ID History report	34
Cancelling	
Fax Forwarding	20, 22
Fax Storage	20
jobs awaiting redial	15
Cleaning	
paper feed rollers	62
paper pick-up rollers	63
printer platen	61
ControlCenter	
See Software User's Guide.	

Copy	
2 in 1 ID	38
2-sided	42
book	41
density	40
enlarge/reduce	36
ink save mode	40
page layout (N in 1)	37
poster	37
quality	35
remove background colour	42
set new default	44
sort	39
thin paper	41
using ADF	39

D

Dialling	
access codes and credit card	
numbers	28
dial prefix	3
Groups (Broadcasting)	12
Direct printing	
from a non-PictBridge camera	58
from a PictBridge camera	56
Dual Access	11

F

Fax codes	
changing	21
Remote Access Code	21
Fax Forwarding	
changing remotely	22, 23
programming a number	17
Fax Storage	18
printing from memory	18
turning off	20
turning on	18
Fax, from PC	
See Software User's Guide.	

Fax, stand-alone	
receiving	
at end of conversation	24
Fax Forwarding	22
into PC	19
into the memory	24
out of paper reception	24
printing from memory	18
recovery printing	25
reducing to fit on paper	24
retrieving from a remote site	22, 23
temporary fax backup	25
sending	8
at end of conversation	11
Broadcasting	12
cancelling from memory	15
contrast	8
delayed batch transmission	15
delayed fax	14
from memory (Dual Access)	11
manual	11
overseas	14
Real Time Transmission	13
Resolution	9
return to factory default	10
set new default	10
Function Lock	4

G

Groups for Broadcasting	31
-------------------------	----

I

ID Copy	38
Ink cartridges	
checking ink volume	64

L

LCD (Liquid Crystal Display)	
Dim Timer	3
Language	3

M

Macintosh	
See Software User's Guide.	
Manual	
transmission	11

Memory Storage	1
Movie printing	46

N

Network	
Printing	
See Network User's Guide.	
Scanning	
See Software User's Guide.	
Nuance™ PaperPort™ 12SE	
See Software User's Guide. Also see Help in the PaperPort™ 12SE application.	

P

Packing and shipping the machine	65
PhotoCapture Center™	
DPOF printing	48
from PC	
See Software User's Guide.	
Print settings	
Borderless	52
Brightness	50
Colour enhancement	51
Contrast	50
Cropping	52
Date Print	53
Paper type & size	49
Quality	48
Return to factory default	54
Set new default	53
Printing	
all photos	47
index	46
photos	47
Scan to Media	
memory card	54
USB Flash memory	54
PictBridge	
DPOF Printing	58
Power failure	1
Presto! PageManager	
See Software User's Guide. Also see Help in the Presto! PageManager application.	
Print	
fax from memory	18
report	34
Printing	
See Software User's Guide.	

R

Reducing	
copies	36
incoming faxes	24
Remote Retrieval	21
commands	22
getting your faxes	23
remote access code	21
Remote Setup	
See Software User's Guide.	
Reports	33
Caller ID History Report	34
Fax Journal	34
Journal Period	33
how to print	34
Network Configuration	34
Quick Dial List	34
Transmission Verification	33, 34
User Settings	34
WLAN Report	34
Resolution	
setting for next fax	9
Restricted users	6

S

Scanning	
See Software User's Guide.	
Security	
Secure function lock	
administrator password	5
restricted users	6
Shipping the machine	65
Sleep Mode	2

T

Troubleshooting	
checking ink volume	64

W

Windows®	
See Software User's Guide.	
Wireless Network	
See Quick Setup Guide and Network User's Guide.	

brother®

Visit us on the World Wide Web
<http://www.brother.com/>

These machines are approved for use in the country of purchase only. Local Brother companies or their dealers will only support machines purchased in their own countries.



www.brotherearth.com