

Please read the Product Safety Guide first, then read this Quick Setup Guide for the correct setup and installation procedure. To view the Quick Setup Guide in other languages, please visit <http://solutions.brother.com/>.

**NOTE**

Not all models are available in all countries.

# 1

## Unpack the machine and check the components

		<p><b>Drum Unit and Toner Cartridge Assemblies</b> (pre-installed) (Black, Cyan, Magenta and Yellow)</p>	
<p><b>Waste Toner Box</b> (pre-installed)</p>	<p><b>CD-ROM</b></p>	<p><b>AC Power Cord</b></p>	<p>(For U.K.) (For Others) <b>Telephone Line Cord</b></p>
<p><b>Belt Unit</b> (pre-installed)</p>	<p><b>Product Safety Guide</b></p>	<p><b>Basic User's Guide</b></p>	<p><b>Quick Setup Guide</b></p>

<b>⚠ WARNING</b>	<u>WARNING</u> indicates a potentially hazardous situation which, if not avoided, could result in death or serious injuries.
<b>⚠ CAUTION</b>	<u>CAUTION</u> indicates a potentially hazardous situation which, if not avoided, may result in minor or moderate injuries.

**⚠ WARNING**

- Plastic bags are used in the packing of your machine. To avoid danger of suffocation, keep these plastic bags away from babies and children. Plastic bags are not toys.
- This machine is heavy and weighs more than 20.0 kg. To prevent possible injuries, at least two people should lift the machine. One person should hold the front of the machine, and one person should hold the back, as shown in the illustration below. Be careful not to trap your fingers when you put the machine down.

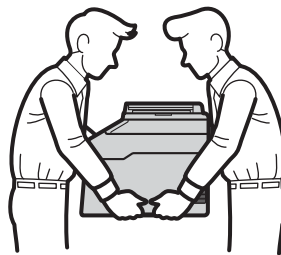

**NOTE**

- Keep a minimum gap around the machine as shown in the illustration.

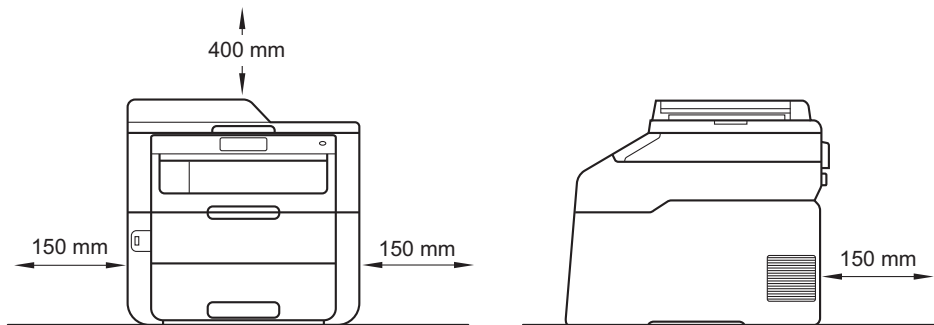

- The components included in the box may differ depending on your country.
- We recommend that you save the original packaging.
- If for any reason you must ship your machine, carefully repack the machine in the original packaging to avoid any damage during transit. The machine should be adequately insured with the carrier. For details on how to repack the machine: >> Advanced User's Guide: *Packing and shipping the machine*.
- Illustrations in this Quick Setup Guide are based on the MFC-9340CDW.
- The interface cable is not a standard accessory. Buy the appropriate interface cable for the connection you want to use (USB or Network).

**USB cable**

- We recommend using a USB 2.0 cable (Type A/B) that is no longer than 2 metres.
- DO NOT connect the interface cable at this time. Connecting the interface cable is done during the MFL-Pro Suite installation process.

**Network cable**

Use a straight-through Category 5 (or greater) twisted-pair cable for 10BASE-T or 100BASE-TX Fast Ethernet Network.

## 2 Remove the packing material from the machine

### ⚠ CAUTION

DO NOT eat the silica gel pack, please throw it away. If ingested, seek medical attention immediately.

### IMPORTANT

DO NOT connect the AC power cord yet.

**a** Remove the packing tape from the outside of the machine, the silica gel pack on the support flap and the film covering the scanner glass.

**b** Fully open the top cover by lifting the handle up **1**.

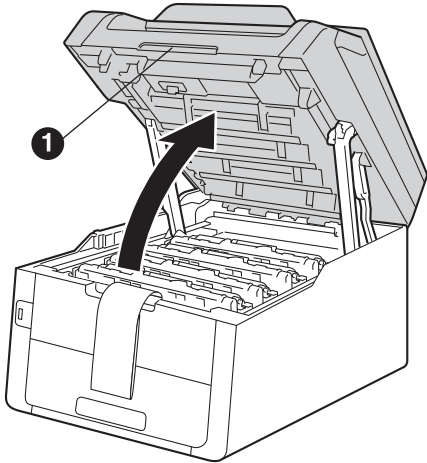

**c** Slide all eight yellow drum locks in the direction of the arrows (the locks may require a firm push).

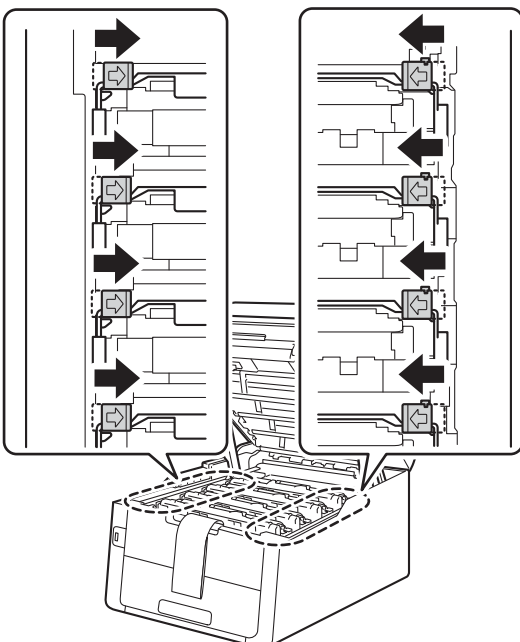

**d** Take out all four drum and toner cartridge assemblies.

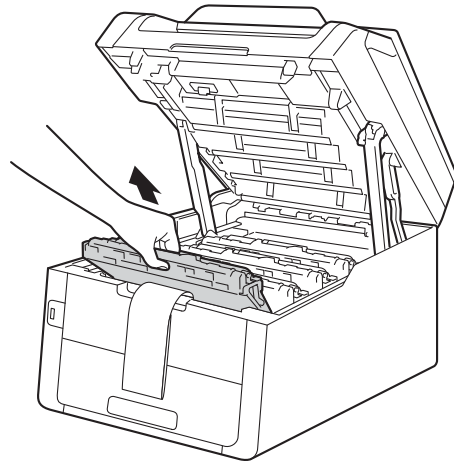

### IMPORTANT

To avoid print quality problems, DO NOT touch the shaded part shown in the illustration.

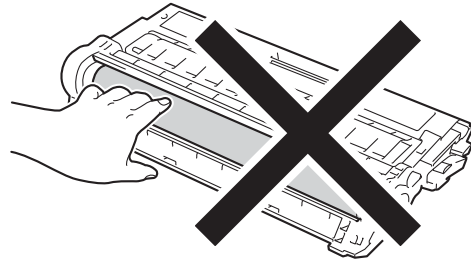

**e** Remove the orange packing piece from the belt unit.

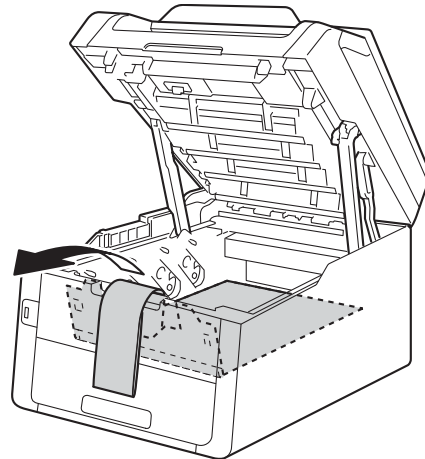

- f** Remove the orange packing piece from each drum and toner cartridge assembly.

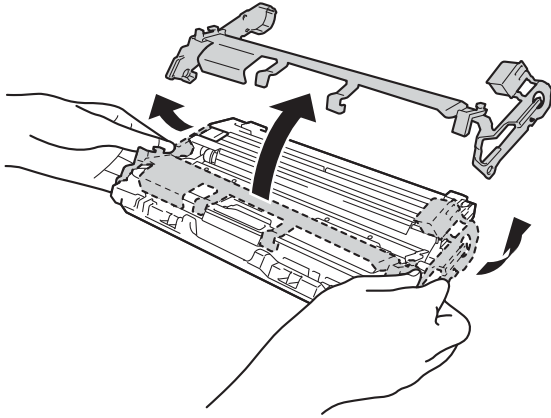

- g** Using both hands, hold each drum and toner cartridge assembly level, and gently shake it from side to side several times to distribute the toner evenly inside the assembly.

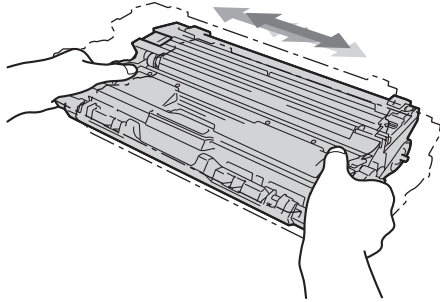

- h** Slide all four drum and toner cartridge assemblies into the machine. Make sure the toner cartridge colour matches the same colour label on the machine.

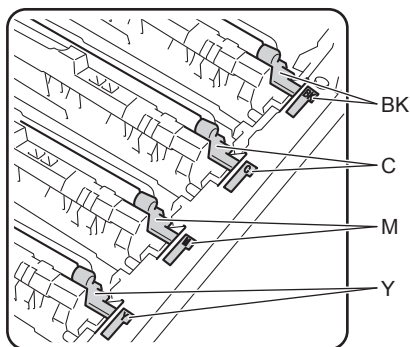

**BK - Black**  
**M - Magenta**

**C - Cyan**  
**Y - Yellow**

- i** Close the top cover of the machine.

## 3 Load paper in the paper tray

- a** Pull the paper tray completely out of the machine.

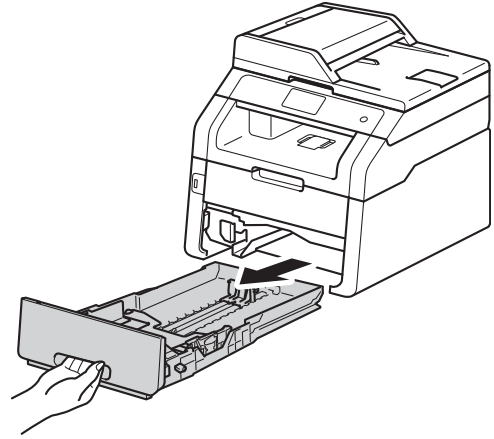

- b** While pressing the green paper-guide release lever ❶, slide the paper guides to fit the paper size you are loading in the tray. Make sure the guides are firmly in the slots.

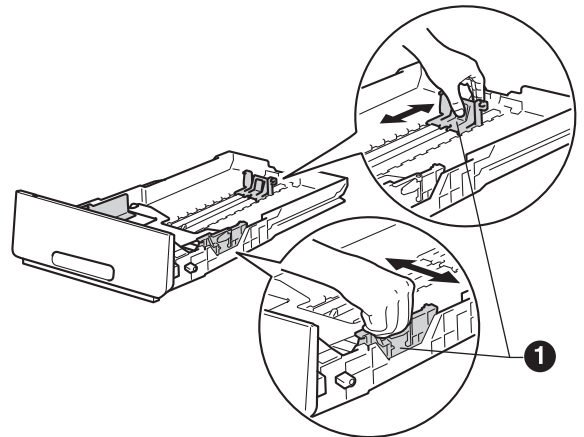

- c** Fan the stack of paper well to avoid paper jams and misfeeds.

- d** Load paper in the tray and make sure:
- The paper is below the maximum paper mark (▼▼▼) ❶. Overfilling the paper tray will cause paper jams.
  - The side to be printed on is face down.
  - The paper guides touch the sides of the paper so it will feed correctly.

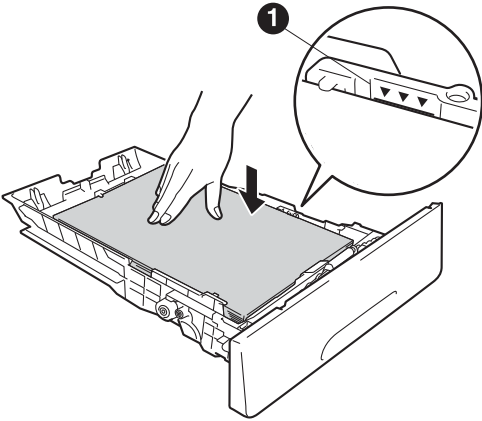

- e** Put the paper tray firmly back in the machine. Make sure it is completely inserted into the machine.

- f** Lift the support flap ❶ to prevent paper from sliding off the face-down output tray.

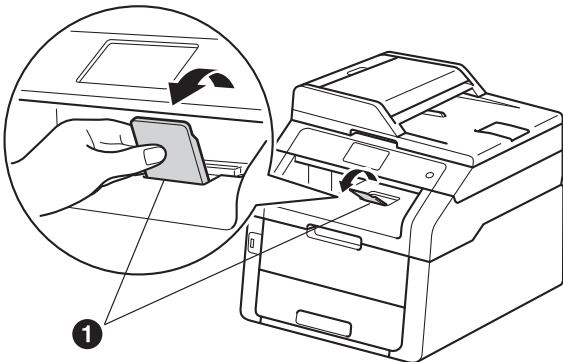

-  For information about recommended paper:  
 >> Basic User's Guide: *Recommended paper and print media.*

## 4 Connect the power cord and telephone line

### IMPORTANT

DO NOT connect the interface cable yet.



- a** Connect the AC power cord to the machine and then plug it into an electrical socket.

- b** Press  on the control panel.

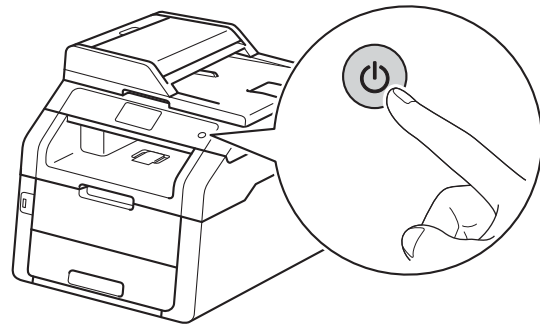

### IMPORTANT

DO NOT touch the Touchscreen immediately after plugging in the power cord or turning the machine on. Doing this may cause an error.

- c** Connect the telephone line cord: connect one end of the telephone line cord to the socket on the machine marked **LINE** and the other end to a telephone wall socket.

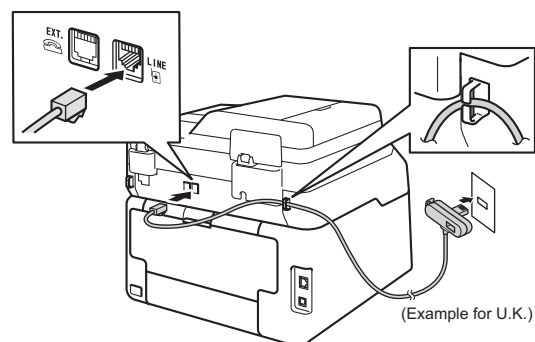

### IMPORTANT

The telephone line cord **MUST** be connected to the socket on the machine marked **LINE**.

## ⚠ WARNING

The machine must be grounded using an earthed plug.

Since the machine is grounded through the electrical socket, you can protect yourself from potentially hazardous electrical conditions on the telephone network by keeping the power cord connected to your machine when you connect it to a telephone line. Similarly, you can protect yourself when you want to move your machine by disconnecting the telephone line first and then disconnecting the power cord.

### NOTE

If you are sharing one telephone line with an external telephone, connect it as shown below.

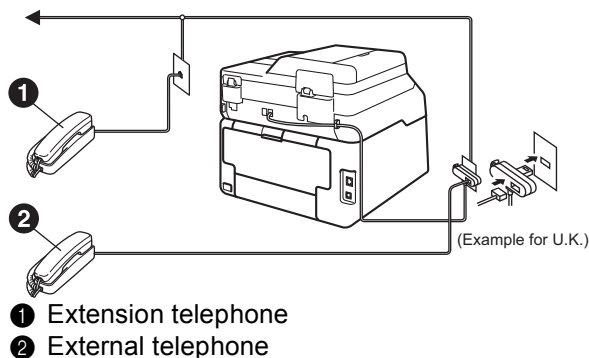

### NOTE

If you are sharing one telephone line with an external telephone answering machine, connect it as shown below.

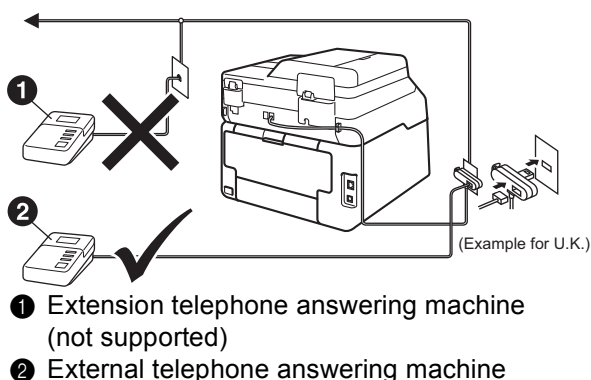



🔍 Set the receive mode to **External TAD** if you have an external answering machine (see *Choose a Receive Mode* >> page 6). For additional details: >> *Basic User's Guide: Connecting an external TAD*.

# 5

## Choose a Receive Mode

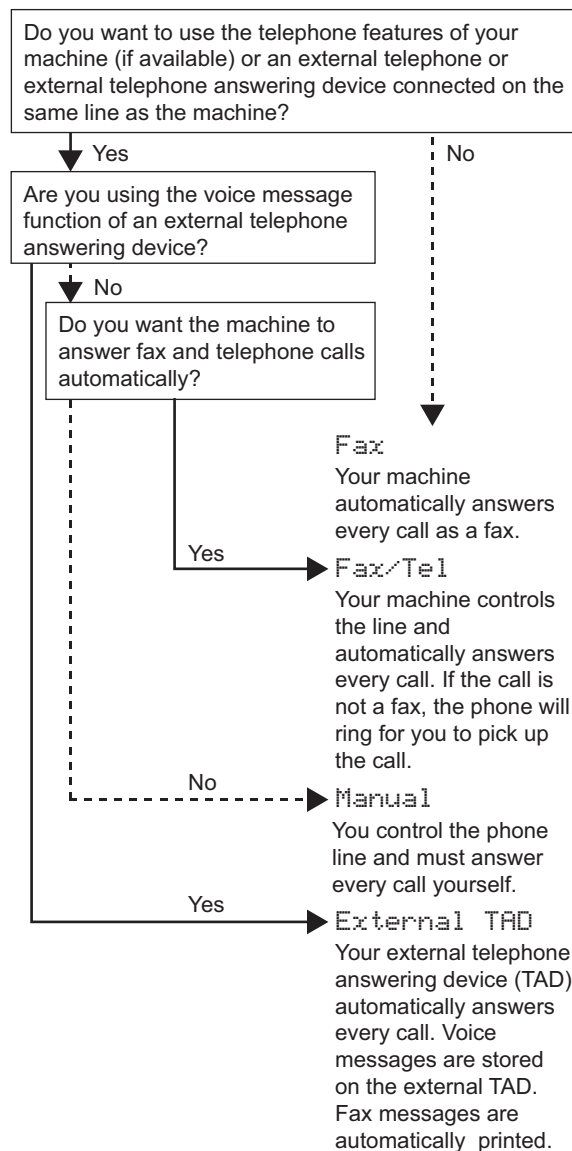
There are four possible receive modes: **Fax**, **Fax/Tel**, **Manual** and **External TAD**.



- a** Press .
- b** Press **All Settings**.
- c** Swipe up or down, or press **▲** or **▼** to display **Fax**.  
Press **Fax**.
- d** Swipe up or down, or press **▲** or **▼** to display **Setup Receive**.  
Press **Setup Receive**.
- e** Swipe up or down, or press **▲** or **▼** to display **Receive Mode**.  
Press **Receive Mode**.

**f** Press your preferred receive mode.

**g** Press .

 For more details: >> Basic User's Guide: *Receiving a fax.*

## 6 Set the date and time

The Touchscreen displays the date and time. You can also add the current date and time to each fax you send by setting your Station ID (see step 7).

**a** Press .

**b** Press  00:00 01.01.2014  
(Date & Time).

**c** Press Date.

**d** Enter the last two digits of the year using the numbers on the Touchscreen, and then press OK.

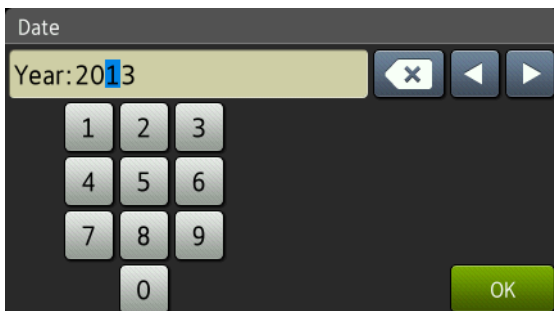

(e.g., Enter 1, 3 for 2013.)

**e** Enter the two digits for the month using the numbers on the Touchscreen, and then press OK.

**f** Enter the two digits for the day using the numbers on the Touchscreen, and then press OK.

**g** Press Time.

**h** Enter the time in 24-hour format using the numbers on the Touchscreen, and then press OK.

**i** Press .

## 7 Enter personal information (Station ID)

Set the machine's Station ID if you want the date and time to appear on each fax you send.

**a** Press .

**b** Press All Settings.

**c** Swipe up or down, or press ▲ or ▼ to display Initial Setup.  
Press Initial Setup.

**d** Swipe up or down, or press ▲ or ▼ to display Station ID.  
Press Station ID.

**e** Press Fax.

**f** Enter your fax number (up to 20 digits) using the numbers on the Touchscreen, and then press OK.



**g** Press Tel.

**h** Enter your telephone number (up to 20 digits) using the numbers on the Touchscreen, and then press OK. If your telephone number and fax number are the same, enter the same number again.

**i** Press Name.

**j** Use the Touchscreen to enter your name (up to 20 characters), and then press OK.

### NOTE

- To enter numbers or special characters, press  repeatedly until the character you want to enter appears, then press the character you want.
- If you entered a character incorrectly and want to change it, press ◀ or ▶ to move the cursor to the incorrect character, then press .
- To enter a space, press Space.
- For more details, see *Entering Text* >> page 33.

**k** Press .

# 8



## Fax Transmission Report

Your Brother machine is equipped with a Transmission Verification Report that can be used as confirmation that you sent a fax. This report lists the name or fax number of the receiving party, the date, time and duration of the transmission, the number of pages transmitted, and whether or not the transmission was successful. If you want to use the Fax Transmission Report feature: >> Advanced User's Guide: *Printing reports*.

# 9

## Set tone or pulse dialling mode

Your machine comes set for a Tone dialling service. If you have a Pulse dialling (rotary) service, you need to change the dialling mode.

- a** Press .
- b** Press `All Settings`.
- c** Swipe up or down, or press ▲ or ▼ to display `Initial Setup`.  
Press `Initial Setup`.
- d** Swipe up or down, or press ▲ or ▼ to display `Tone/Pulse`.  
Press `Tone/Pulse`.
- e** Press `Pulse (or Tone)`.
- f** Press .



# 10

## Set the telephone line compatibility

If you are connecting the machine to a VoIP service (over the Internet) you need to change the compatibility setting.

### NOTE

If you are using an analogue telephone line, skip this step.

- a** Press .
- b** Press `All Settings`.
- c** Swipe up or down, or press ▲ or ▼ to display `Initial Setup`.  
Press `Initial Setup`.
- d** Swipe up or down, or press ▲ or ▼ to display `Compatibility`.  
Press `Compatibility`.
- e** Press `Basic (for VoIP)`.
- f** Press .



# 11 Set the telephone line type

If you are connecting the machine to a line that features a PABX (PBX) or ISDN to send and receive faxes, it is also necessary to change the phone line type accordingly by completing the following steps.

- a** Press .
- b** Press **All Settings**.
- c** Swipe up or down, or press **▲** or **▼** to display **Initial Setup**.  
Press **Initial Setup**.
- d** Swipe up or down, or press **▲** or **▼** to display **Phone Line Set**.  
Press **Phone Line Set**.
- e** Press **Normal**, **ISDN** or **PBX**.  
Do one of the following:
  - If you choose **ISDN** or **Normal**, go to step **i**.
  - If you choose **PBX**, go to step **f**.
- f** Do one of the following:
  - If you want to change the current prefix number, press **On** or **Always** and go to step **g**.
  - If you do not want to change the current prefix number, go to step **i**.

## NOTE

- The default prefix setting is “!”.
- If you choose **On**, pressing **R** will let you access an outside line.
- If you choose **Always**, you can access an outside line without pressing **R**.

- g** Press **Dial Prefix**.
- h** Enter the prefix number (up to five digits) using the buttons on the Touchscreen, and then press **OK**.

## NOTE

- You can use the numbers 0 to 9, and the characters #, \* and !.
- You cannot use ! with any other numbers or characters.
- If your telephone system requires a timed break recall, press ! on the Touchscreen.

- i** Press .



## NOTE

### PBX and TRANSFER

The machine is initially set to **Normal**, which lets the machine connect to a standard PSTN (Public Switched Telephone Network) line. However, many offices use a central telephone system or Private Automatic Branch Exchange (PABX). Your machine can be connected to most types of PABX (PBX). The machine's recall feature supports timed break recall only (TBR). TBR will work with most PABX (PBX) systems allowing you to gain access to an outside line, or transfer calls to another extension. The feature works when **R** is pressed.

# 12 Automatic Daylight Saving Time

You can set the machine to change automatically for Daylight Saving Time. It will reset itself forward one hour in the spring and backward one hour in the autumn.

- a** Press .
- b** Press  **00:00 01.01.2014**  
(Date & Time).
- c** Press **Auto Daylight**.
- d** Press **On** (or **Off**).
- e** Press .

# 13

## Set the Time Zone

You can set the time zone on the machine for your location.

**a** Press .

**b** Press  00:00 01.01.2014  
(Date & Time).

**c** Press Time Zone.

**d** Enter your time zone.  
Press OK.

**e** Press .

# 14 Choose your connection type

These installation instructions are for Windows® XP Home/Windows® XP Professional, Windows® XP Professional x64 Edition, Windows Vista®, Windows® 7, Windows® 8, and Mac OS X v10.6.8, 10.7.x and 10.8.x.

## NOTE

- For Windows Server® 2003/2003 x64 Edition/2008/2008 R2/2012 and Linux®, visit your model page at <http://solutions.brother.com/>.
- You can visit us at <http://solutions.brother.com/> where you can get product support, the latest driver updates and utilities, and answers to frequently asked questions (FAQs).

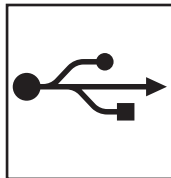
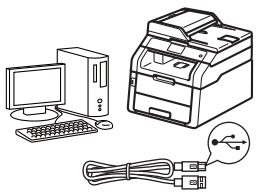

## For USB Interface Cables

Windows®, go to page 12  
Macintosh, go to page 14

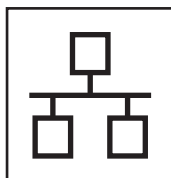
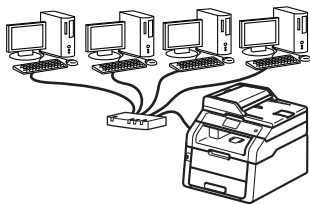

## For Wired Network

Windows®, go to page 16  
Macintosh, go to page 19

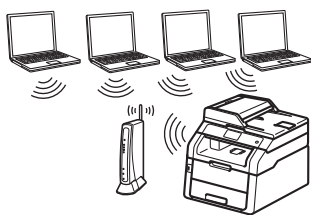

## For Wireless Network

Windows® and Macintosh,  
go to page 21

## NOTE

To connect your iOS device, Android™ device, or Windows® Phone to your Brother machine using Wi-Fi Direct™, please download the Wi-Fi Direct™ Guide at <http://solutions.brother.com/>.

Windows®  
Macintosh

Windows®  
Macintosh

Windows®  
Macintosh



## For Windows® USB Interface Users (Windows® XP/XP Professional x64 Edition/Windows Vista®/ Windows® 7/Windows® 8)

### 15 Before you install

#### IMPORTANT

- If there are any programs running, close them.
- The screens may differ depending on your operating system.

#### NOTE

The CD-ROM includes Nuance™ PaperPort™ 12SE. This software supports Windows® XP (SP3 or greater), XP Professional x64 Edition (SP2 or greater), Windows Vista® (SP2 or greater), Windows® 7 and Windows® 8. Update to the latest Windows® Service Pack before installing MFL-Pro Suite.

- Make sure your computer is ON and you are logged on with Administrator rights.
- Press and hold down  to turn off the machine, and make sure the USB interface cable is **NOT** connected. If you have already connected the cable, disconnect it.

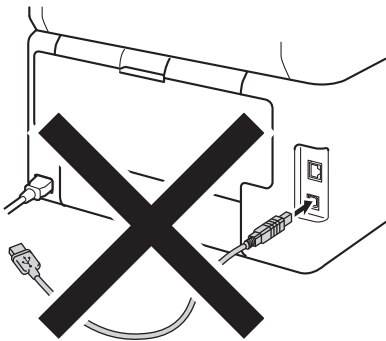

### 16 Install MFL-Pro Suite

- Put the CD-ROM into your CD-ROM drive. If the model name screen appears, choose your machine. If the language screen appears, choose your language.

#### NOTE

- If the Brother screen does not appear automatically, go to **Computer (My Computer)**.  
(For Windows® 8: click the  (**File Explorer**) icon on the taskbar, and then go to **Computer**.) Double-click the CD-ROM icon, and then double-click **start.exe**.
- If the **User Account Control** screen appears, click **Continue** or **Yes**.

- Click **Install MFL-Pro Suite**, and click **Yes** in the next two windows if you accept the license agreements.



#### NOTE

If the installation does not continue automatically, restart the installation by ejecting and then reinserting the CD-ROM or by double-clicking the **start.exe** program from the root folder. Continue from step **b** to install MFL-Pro Suite.

- Choose **Local Connection (USB)**, and then click **Next**.

#### NOTE

To install the PS driver (BR-Script3 printer driver), choose **Custom Install**, and then follow the on-screen instructions.



- d** Follow the on-screen instructions until the **Plug in the USB cable** screen appears.

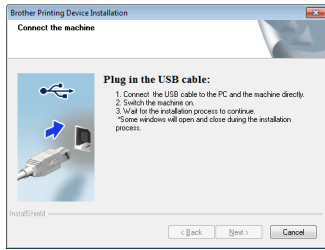

- e** Connect the USB cable to the USB port marked with the  symbol on your machine, and then connect the cable to your computer.

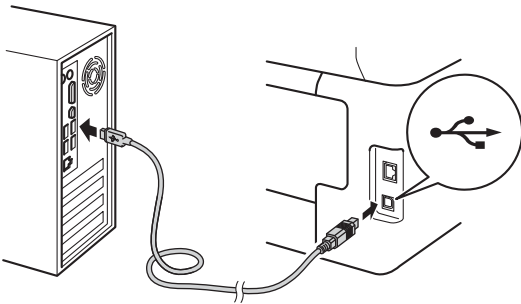

- f** Press  to turn on the machine.  
The installation will automatically continue. The installation screens appear one after another. If prompted, follow any on-screen instructions.

### IMPORTANT

DO NOT cancel any of the screens during the installation. It may take a few minutes for all screens to appear.

### NOTE



If the **Windows Security** screen appears, select the check box and click **Install** to complete the installation correctly.

- g** When the **On-Line Registration** screen appears, make your selection and follow the on-screen instructions. Once you have completed the registration process, click **Next**.
- h** When the **Setup is Complete** screen appears, make your selection, and then click **Next**.

## 17 Finish and restart

- a** Click **Finish** to restart your computer. After restarting the computer, you must log on with Administrator rights.

### NOTE

- If an error message appears during the software installation, do one of the following:
  - For Windows® XP, Windows Vista® and Windows® 7 users: run the **Installation Diagnostics** located in  (**Start**) > **All Programs** > **Brother** > **MFC-XXXX** (where MFC-XXXX is your model name).
  - For Windows® 8 users: to run **Installation Diagnostics**, double-click the  (**Brother Utilities**) icon on the desktop, and then click the drop-down list and select your model name (if not already selected). Click **Tools** in the left navigation bar.
- Depending on your security settings when using the machine or its software, a Windows® Security or antivirus software window may appear. Please allow or permit the window to continue.

## Finish

The installation is now complete.

### NOTE

- For Windows® 8 users: if the Brother manuals included on the CD-ROM are in PDF format, use Adobe® Reader® to open them. If Adobe® Reader® is installed on your computer but cannot open the files in Adobe® Reader®, change the file association for PDF (see *How to open a PDF file in Adobe® Reader® (Windows® 8)* >> page 40).
- XML Paper Specification Printer Driver**  
The XML Paper Specification Printer Driver is the most suitable driver for Windows Vista®, Windows® 7 and Windows® 8 when printing from applications that use the XML Paper Specification. Please download the latest driver from the Brother Solutions Center at <http://solutions.brother.com/>.



## For Macintosh USB Interface Users (Mac OS X v10.6.8, 10.7.x, 10.8.x)

### 15 Before you install

#### IMPORTANT

For Mac OS X v10.6.7 or lower users: upgrade to Mac OS X v10.6.8, 10.7.x, 10.8.x. (For the latest drivers and information for the Mac OS X you are using, visit <http://solutions.brother.com/>.)

- a** Make sure your machine is connected to an AC power source and your Macintosh is ON. You must be logged on with Administrator rights.
- b** Connect the USB cable to the USB port marked with the  symbol on your machine, and then connect the cable to your Macintosh.

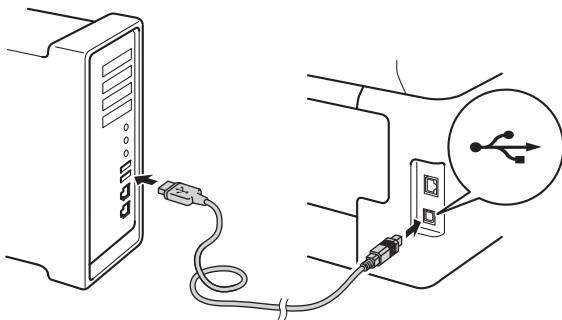

- c** Make sure your machine is turned on.

### 16 Install MFL-Pro Suite

- a** Put the CD-ROM into your CD-ROM drive, and then double-click the **BROTHER** icon on your desktop.
- b** Double-click the **Start Here OSX** icon. If prompted, select your model.



- c** (MFC-9330CDW / MFC-9340CDW) Choose **Local Connection (USB)**, and then click **Next**.
- d** The installation screens appear one after another. If prompted, follow any on-screen instructions.

#### IMPORTANT

DO NOT cancel any of the screens during the installation. It may take a few minutes for the installation to complete.

- e** Choose your machine from the list, and then click **Next**.

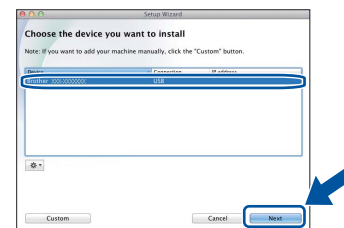

- f** When the **Add Printer** screen appears, click **Add Printer**.
- g** Choose your machine from the list, click **Add**, and then click **Next**.

#### NOTE

To add the PS driver (BR-Script3 printer driver), select it from the **Print Using (Use)** pop-up menu.

-  **The installation of MFL-Pro Suite is now complete. Go to step 17 on page 15.**



## 17 Download and install Presto! PageManager

When Presto! PageManager is installed, OCR capability is added to Brother ControlCenter2. You can easily scan, share and organize photos and documents using Presto! PageManager.

- a On the **Brother Support** screen, click **Presto! PageManager** and follow the on-screen instructions.



**Finish** The installation is now complete.

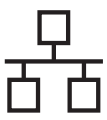

## For Windows® Wired Network Interface Users (Windows® XP/XP Professional x64 Edition/Windows Vista®/ Windows® 7/Windows® 8)

### 15 Before you install

#### IMPORTANT

- If there are any programs running, close them.
- The screens may differ depending on your operating system.

#### NOTE

- The CD-ROM includes Nuance™ PaperPort™ 12SE. This software supports Windows® XP (SP3 or greater), XP Professional x64 Edition (SP2 or greater), Windows Vista® (SP2 or greater), Windows® 7 and Windows® 8. Update to the latest Windows® Service Pack before installing MFL-Pro Suite.
- Disable all personal firewall software (other than Windows® Firewall), anti-spyware, or antivirus applications for the duration of the installation.

- a** Make sure your computer is ON and you are logged on with Administrator rights.
- b** Remove the protective cap from the Ethernet port marked with a  symbol on your machine.

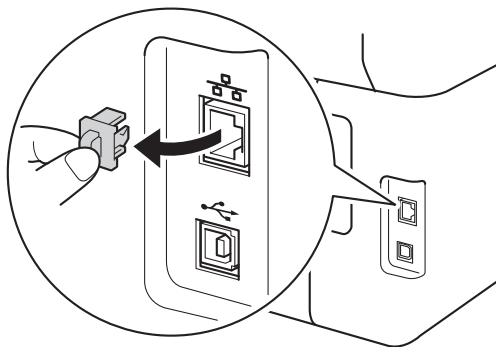

- c** Connect the network interface cable to the Ethernet port on your machine, and then connect it to a free port on your hub.

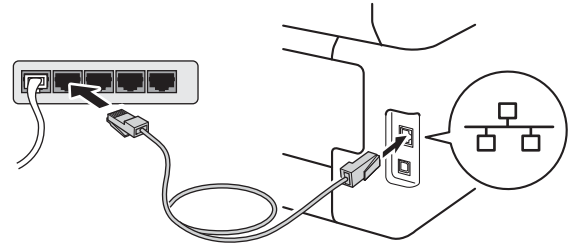

- d** Make sure your machine is turned on.

### 16 Install MFL-Pro Suite

- a** Put the CD-ROM into your CD-ROM drive. If the model name screen appears, choose your machine. If the language screen appears, choose your language.

#### NOTE

- If the Brother screen does not appear automatically, go to **Computer (My Computer)**.

(For Windows® 8: click the  (**File Explorer**) icon on the taskbar, and then go to **Computer**.) Double-click the CD-ROM icon, and then double-click **start.exe**.

- If the **User Account Control** screen appears, click **Continue** or **Yes**.

- b** Click **Install MFL-Pro Suite**, and click **Yes** in the next two windows if you accept the license agreements.

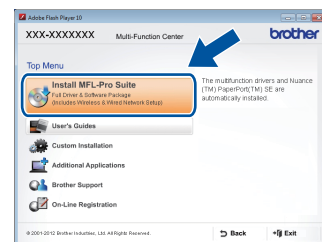

#### NOTE

If the installation does not continue automatically, restart the installation by ejecting and then reinserting the CD-ROM or by double-clicking the **start.exe** program from the root folder. Continue from step **b** to install MFL-Pro Suite.



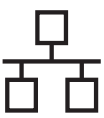

- c** Choose **Wired Network Connection (Ethernet)**, and then click **Next**.

## NOTE

To install the PS driver (BR-Script3 printer driver), choose **Custom Install**, and then follow the on-screen instructions.

- d** When the **Firewall/AntiVirus detected** screen appears, choose **Change the Firewall port settings to enable network connection and continue with the installation. (Recommended)** and click **Next**.

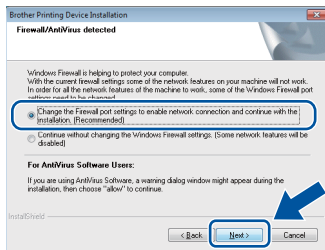

If you are not using the Windows® Firewall, see the user's guide for your software for information on how to add the following network ports:

- For network scanning, add UDP port 54925.
- For network PC-Fax receiving, add UDP port 54926.
- If you still have trouble with your network connection, add UDP ports 161 and 137.

- e** The installation will automatically continue. The installation screens appear one after another. If prompted, follow any on-screen instructions.

## IMPORTANT

DO NOT cancel any of the screens during the installation. It may take a few minutes for all screens to appear.

## NOTE

- If prompted, choose your machine from the list, and then click **Next**.
- If your machine is not found over the network, confirm your settings by following the on-screen instructions.
- If there is more than one of the same model connected on your network, the IP Address and Node Name will be displayed to help you identify the machine.
- You can find your machine's IP address and the Node Name by printing out the Network Configuration Report (see *Print the Network Configuration Report* >> page 39).
- If the **Windows Security** screen appears, select the check box and click **Install** to complete the installation correctly.

- f** When the **On-Line Registration** screen appears, make your selection and follow the on-screen instructions. Once you have completed the registration process, click **Next**.

- g** When the **Setup is Complete** screen appears, make your selection, and then click **Next**.

## 17 Finish and restart

- a** Click **Finish** to restart your computer. After restarting the computer, you must log on with Administrator rights.

## NOTE

- If an error message appears during the software installation, do one of the following:
  - For Windows® XP, Windows Vista® and Windows® 7 users: run the **Installation Diagnostics** located in **(Start) > All Programs > Brother > MFC-XXXX LAN** (where MFC-XXXX is your model name).
  - For Windows® 8 users: to run **Installation Diagnostics**, double-click the **(Brother Utilities)** icon on the desktop, and then click the drop-down list and select your model name (if not already selected). Click **Tools** in the left navigation bar.
- Depending on your security settings when using the machine or its software, a Windows® Security or antivirus software window may appear. Please allow or permit the window to continue.

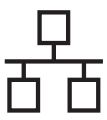

## 18

### Install MFL-Pro Suite on additional computers (if needed)

If you want to use your machine with multiple computers on the network, install MFL-Pro Suite on each computer. Go to step **15** on page 16.

#### NOTE

##### Network license (Windows®)

This product includes a PC license for up to five users. This license supports the installation of the MFL-Pro Suite including Nuance™ PaperPort™ 12SE on up to five PCs on the network. If you want to use more than five PCs with Nuance™ PaperPort™ 12SE installed, please purchase the Brother NL-5 pack which is a multiple PC license agreement pack for up to five additional users. To purchase the NL-5 pack, contact your authorized Brother dealer or contact Brother customer service.

## Finish

**The installation is now complete.**

#### NOTE

- For Windows® 8 users: if the Brother manuals included on the CD-ROM are in PDF format, use Adobe® Reader® to open them. If Adobe® Reader® is installed on your computer but cannot open the files in Adobe® Reader®, change the file association for PDF (see *How to open a PDF file in Adobe® Reader® (Windows® 8)* >> page 40).
- **XML Paper Specification Printer Driver**  
The XML Paper Specification Printer Driver is the most suitable driver for Windows Vista®, Windows® 7 and Windows® 8 when printing from applications that use the XML Paper Specification. Please download the latest driver from the Brother Solutions Center at <http://solutions.brother.com/>.

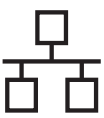

## For Macintosh Wired Network Interface Users (Mac OS X v10.6.8, 10.7.x, 10.8.x)

### 15 Before you install

#### IMPORTANT

For Mac OS X v10.6.7 or lower users: upgrade to Mac OS X v10.6.8, 10.7.x, 10.8.x. (For the latest drivers and information for the Mac OS X you are using, visit <http://solutions.brother.com/>.)

- a Make sure your machine is connected to an AC power source and your Macintosh is ON. You must be logged on with Administrator rights.
- b Remove the protective cap from the Ethernet port marked with a  symbol on your machine.

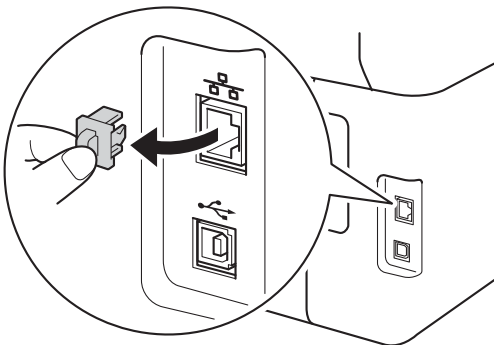

- c Connect the network interface cable to the Ethernet port on your machine, and then connect it to a free port on your hub.

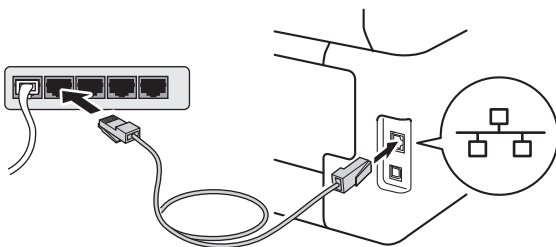

- d Make sure your machine is turned on.

### 16 Install MFL-Pro Suite

- a Put the CD-ROM into your CD-ROM drive, and then double-click the **BROTHER** icon on your desktop.
- b Double-click the **Start Here OSX** icon. If prompted, select your model.



- c (MFC-9330CDW / MFC-9340CDW)  
Choose **Wired Network Connection (Ethernet)**, and then click **Next**.

- d The installation screens appear one after another. If prompted, follow any on-screen instructions.

#### IMPORTANT

DO NOT cancel any of the screens during the installation. It may take a few minutes for the installation to complete.

- e Choose your machine from the list, and then click **Next**.

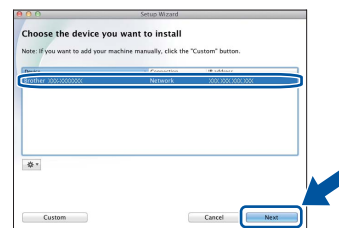

#### NOTE

If your machine is not found over the network, confirm your network settings (see *Before you install* >> page 19).

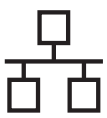

## NOTE

- If there is more than one of the same model connected on your network, the IP Address will be displayed to help you identify the machine.
- You can find your machine's IP Address by printing out the Network Configuration Report (see *Print the Network Configuration Report* >> page 39).
- If the **Setup Network "Scan to" name** screen appears, follow the instructions below:

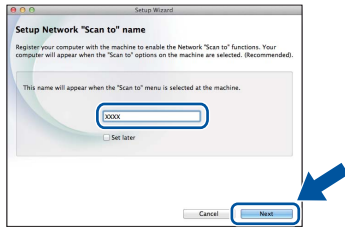

- 1) Enter a name for your Macintosh (up to 15 characters long).
- 2) Click **Next**. Go to **f**.

The name you enter will appear on the machine's Touchscreen when you press the **Scan** button and choose a scan option (for more information: >> *Software User's Guide*).

- f** When the **Add Printer** screen appears, click **Add Printer**.
- g** Choose your machine from the list, click **Add**, and then click **Next**.  
(OS X v10.8.x)  
Select **MFC-XXXX CUPS** driver from the **Use** pop-up menu (where XXXX is your model name).

## NOTE

To add the PS driver (BR-Script3 printer driver), select it from the **Print Using (Use)** pop-up menu.



**The installation of MFL-Pro Suite is now complete.**  
Go to step **17** on page 20.

# 17

## Download and install Presto! PageManager

When Presto! PageManager is installed, OCR capability is added to Brother ControlCenter2. You can easily scan, share and organize photos and documents using Presto! PageManager.

- a** On the **Brother Support** screen, click **Presto! PageManager** and follow the on-screen instructions.



# 18

## Install MFL-Pro Suite on additional computers (if needed)

If you want to use your machine with multiple computers on the network, install MFL-Pro Suite on each computer. Go to step **15** on page 19.

**Finish**

**The installation is now complete.**



## For Wireless Network Interface Users (MFC-9330CDW / MFC-9340CDW)

### 15 Before you begin

First you must configure the wireless network settings of your machine to communicate with your wireless access point/router. After the machine is configured to communicate with your wireless access point/router, the computers and mobile devices on your network will have access to the machine. To use the machine from a computer, you must install the drivers and software. The following steps will guide you through the configuration and installation process:

#### IMPORTANT

- If you are going to connect the machine to your network, we recommend that you contact your system administrator prior to installation. You must know your wireless network settings before you proceed with this installation.
- If you have previously configured the wireless settings of the machine, you must reset the network settings before you can configure the wireless settings again.
  1. On your machine, press , and **All Settings**.
  2. Swipe up or down, or press **▲** or **▼** to display **Network**, and press **Network**.
  3. Swipe up or down, or press **▲** or **▼** to display **Network Reset**, and press **Network Reset**.
  4. Press **Yes**.
  5. Press **Yes** for two seconds.

#### NOTE

- To achieve optimum results with normal everyday document printing, place the Brother machine as close to the wireless access point/router as possible, with minimal obstructions. Large objects and walls between the two devices and interference from other electronic devices can affect the data transfer speed of your documents.  
Due to these factors, wireless may not be the best method of connection for all types of documents and applications. If you are printing large files, such as multi-page documents with mixed text and large graphics, you may want to consider choosing wired Ethernet for a faster data transfer or USB for the fastest throughput speed.
- Although the Brother MFC-9330CDW and MFC-9340CDW can be used in both a wired and a wireless network, only one of the connection methods can be used at a time.
- If you use your machine in an IEEE 802.1x supported wireless network: **➤➤ Network User's Guide: Using IEEE 802.1x authentication.**

#### Infrastructure Mode

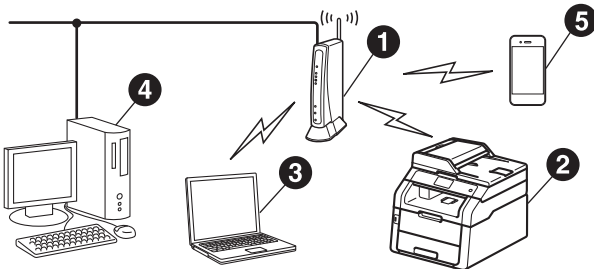

- 1 Wireless access point/router
- 2 Wireless Network machine (your machine)
- 3 Wireless capable computer connected to the wireless access point/router
- 4 Wired computer connected to the wireless access point/router
- 5 Mobile device connected to the wireless access point/router



## 16 Choose your wireless setup method

The following instructions will offer three methods for setting up your Brother machine on a wireless network. Choose the method you prefer for your environment.

For methods **b** and **c**, start your wireless setup by pressing the  button on the Touchscreen.

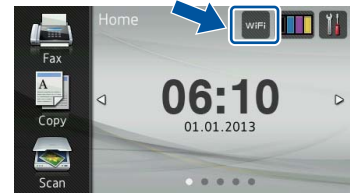

### **a** Setup using the CD-ROM and temporarily using a USB cable (Windows® and Macintosh)

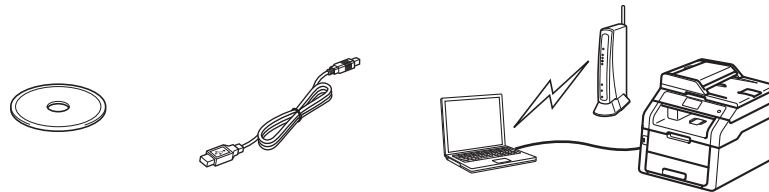

We recommend using a computer wirelessly connected to your network for this method.

#### **IMPORTANT**

- You need to temporarily use a USB cable during configuration (cable not included).
- If you are using Windows® XP, or using a network cable to connect your computer to your wireless access point/router, you need to know the SSID (Network Name) and Network Key of your wireless access point/router before you proceed. Please write down your wireless network settings in the area below.
- If you need assistance during setup and want to contact Brother Customer Service, make sure you have your SSID and Network Key ready. We cannot assist you in locating this information.

Item	Record the current wireless network settings
SSID (Network Name)	
Network Key* (Security Key/Encryption Key)	

\* The Network Key may also be described as the Password, Security Key, or Encryption Key.

#### **NOTE**

- If you do not know this information (SSID and Network Key), you cannot continue the wireless setup.
- To find this information (SSID and Network Key):
  1. Check the documentation provided with your wireless access point/router.
  2. The default SSID could be the access point/router manufacturer's name or the model name.
  3. If you do not know the security information, please consult the router manufacturer, your system administrator, or your internet provider.

**Now go to**

**page 24**



## **b** Manual setup from the control panel using the Setup Wizard (Windows®, Macintosh and mobile devices)

If your wireless access point/router does not support WPS (Wi-Fi Protected Setup™) or AOSS™, write down the wireless network settings of your wireless access point/router in the area below.

### **IMPORTANT**

If you need assistance during setup and want to contact Brother Customer Service, make sure you have your SSID (Network Name) and Network Key ready. We cannot assist you in locating this information.

Item	Record the current wireless network settings
SSID (Network Name)	
Network Key* (Security Key/Encryption Key)	

\* The Network Key may also be described as the Password, Security Key, or Encryption Key.

### **NOTE**

- If you do not know this information (SSID and Network Key), you cannot continue the wireless setup.
- To find this information (SSID and Network Key):
  1. Check the documentation provided with your wireless access point/router.
  2. The default SSID could be the access point/router manufacturer's name or the model name.
  3. If you do not know the security information, please consult the router manufacturer, your system administrator, or your internet provider.

Now go to

page 27

## **c** One-push setup using WPS or AOSS™ (Windows®, Macintosh and mobile devices)

Use this method if your wireless access point/router supports automatic wireless (one-push) setup (WPS or AOSS™).

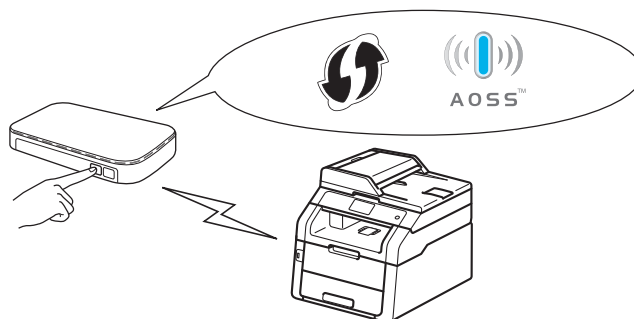

Now go to

page 29



## Setup using the CD-ROM and temporarily using a USB cable (Windows® and Macintosh)

### 17 Set up the wireless settings

#### IMPORTANT

- You need to temporarily use a USB cable during configuration (cable not included).
- If you are using Windows® XP, or using a network cable to connect your computer to your wireless access point/router, you need to know the SSID and Network Key of your wireless access point/router that you wrote down in step **16-a** on page 22 before you proceed.

#### NOTE

- If you use your machine in an IEEE 802.1x supported wireless network: >> Network User's Guide: *Using IEEE 802.1x authentication.*
- The screens in this step are from Windows®. The screens on your computer will vary depending on your operating system.

**a** Put the CD-ROM into your CD-ROM drive.

#### NOTE

(Windows®)

- If the model name screen appears, choose your machine. If the language screen appears, choose your language.
- If the Brother screen does not appear automatically, go to **Computer (My Computer)**.

(For Windows® 8: click the  (File Explorer) icon on the taskbar, and then go to **Computer**.) Double-click the CD-ROM icon, and then double-click **start.exe**.

- If the **User Account Control** screen appears, click **Continue** or **Yes**.

**b** (Windows®)

Click **Install MFL-Pro Suite**, and click **Yes** in the next two windows if you accept the license agreements.



#### NOTE

If the installation does not continue automatically, restart the installation by ejecting and then reinserting the CD-ROM or by double-clicking the **start.exe** program from the root folder. Continue from step **b** to install MFL-Pro Suite.

(Macintosh)

Double-click the **BROTHER** icon on your desktop, and then double-click the **Start Here OSX** icon on the screen. If prompted, select your model.



**c** Choose **Wireless Network Connection**, and then click **Next**.

- For Windows®, go to **d**
- For Macintosh, go to **e**

#### NOTE

(Windows®)

To install the PS driver (BR-Script3 printer driver), choose **Custom Install**, and then follow the on-screen instructions.





# For Wireless Network Users

**d** When the **Firewall/AntiVirus detected** screen appears, choose **Change the Firewall port settings to enable network connection and continue with the installation. (Recommended)** and click **Next**.

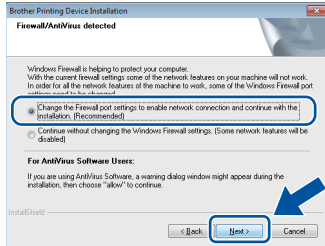

If you are not using the Windows® Firewall, see the user's guide for your software for information on how to add the following network ports:

- For network scanning, add UDP port 54925.
- For network PC-Fax receiving, add UDP port 54926.
- If you still have trouble with your network connection, add UDP ports 161 and 137.

**e** Choose **Yes, I have a USB cable to use for installation.**, and then click **Next**.

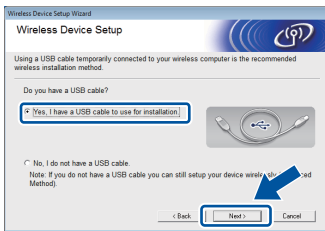

## NOTE

If the **Important Notice** screen appears, read the notice. Check the box after you confirm the SSID and Network Key, and then click **Next**.

**f** Temporarily connect the USB cable (not included) directly to the computer and the machine.

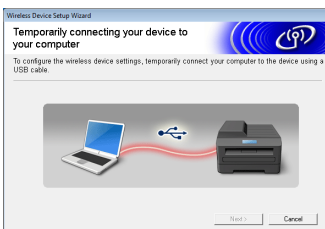

**g** Do one of the following:

- If the **Installation confirmation** screen appears, check the box and click **Next**, and then go to **h**.
- If the **Installation confirmation** screen does not appear, go to **i**.

**h** Check **Yes** if you want to connect with the listed SSID. Click **Next**, and then go to **k**.

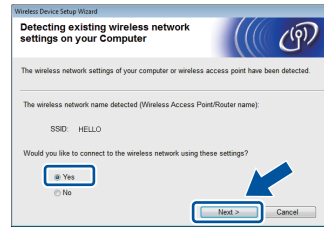

**i** The wizard will search for available wireless networks from your machine. Choose the SSID that you wrote down for your network in step **16-a** on page 22, and then click **Next**.

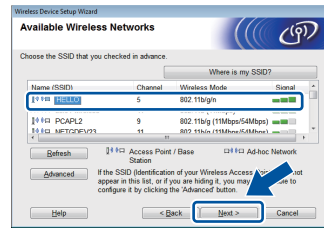

## NOTE

- If the list is blank, check that the wireless access point/router has power and is broadcasting the SSID. See if the machine and the wireless access point/router are within range for wireless communication. Click **Refresh**.
- If your wireless access point/router is set to not broadcast the SSID, manually add it by clicking the **Advanced** button. Follow the on-screen instructions for entering the **Name(SSID)**, and then click **Next**.

**j** Enter the **Network Key** you wrote down in step **16-a** on page 22, and then click **Next**.

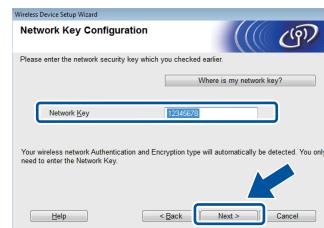

## NOTE

If your network is not configured for Authentication and Encryption, the **ATTENTION!** screen will appear. To continue configuration, click **OK**.



- k** Confirm the wireless network settings, and then click **Next**. The settings will be sent to your machine.

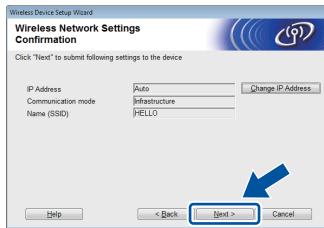

## NOTE

- The settings will remain unchanged if you click **Cancel**.
- To manually enter the IP address settings of your machine, click **Change IP Address** and enter the necessary IP address settings for your network.
- If the wireless setup failure screen appears, click **Retry**.

Disconnect the USB cable between the computer and the machine, and then click **Next**.



**Wireless setup is now complete.** A four-level indicator at the top right of your machine's Touchscreen will show the wireless signal strength of your wireless access point/router.

To install the MFL-Pro Suite, continue to **step 19**.

For Windows® Users:

**Now go to  
step 19-e on page 35**

For Macintosh Users:

**Now go to  
step 19-d on page 37**



## Manual setup from the control panel using the Setup Wizard (Windows®, Macintosh and mobile devices)

### 17 Set up the wireless settings

#### IMPORTANT

You must have the wireless settings you wrote down for your network in step **16-b** on page 23 before you proceed.

#### NOTE

If you use your machine in an IEEE 802.1x supported wireless network: >> Network User's Guide: *Using IEEE 802.1x authentication*.

- a** On your machine, press . Press **Setup Wizard**.
- b** When **Enable WLAN?** is displayed, press **Yes**. This will start the wireless setup wizard.
- c** The machine will search for available SSIDs. It will take a few minutes to display a list of available SSIDs.  
If a list of SSIDs is displayed, swipe up or down, or press **▲** or **▼** to choose the SSID you wrote down in step **16-b** on page 23.  
Press **OK**.

#### NOTE

- If the list is blank, check that the wireless access point/router has power and is broadcasting the SSID. Move your machine closer to the wireless access point/router and try starting from **a** again.
- If your wireless access point/router is set to not broadcast the SSID you will have to manually add the SSID name. For details: >> Network User's Guide: *Configuring your machine when the SSID is not broadcast*.

- d** Do one of the following:
  - If the wireless access point/router of the selected SSID supports WPS and the machine asks to use WPS, go to **e**.
  - If you are using an authentication and encryption method that requires a Network Key, go to **f**.
  - If your authentication method is Open System and your encryption mode is None, go to **g**.

- e** To connect your machine using the automatic wireless mode, press **Yes**. (If you choose **No (Manual)**, go to **f** to enter the Network Key.) When the Touchscreen instructs you to start WPS, press the WPS button on your wireless access point/router, and then press **Next** on the Touchscreen. Go to **g**.

- f** Enter the Network Key you wrote down in step **16-b** on page 23 using the numbers and characters on the Touchscreen.

#### NOTE

- To enter numbers or special characters, press repeatedly until the character you want to enter appears, then press the character you want.
- If you entered a character incorrectly and want to change it, press **◀** or **▶** to move the cursor to the incorrect character, then press .
- To enter a space, press **Space**.
- For more details, see *Entering Text* >> page 33.

Press **OK** when you have entered all the characters, and then press **Yes** to apply your settings.

- g** Your machine will now try to connect to your wireless network using the information you have entered.

A connection result message appears on the Touchscreen and a WLAN report will automatically print.

If the connection failed, check the error code on the printed report and refer to *Troubleshooting* >> page 30.

Press **OK**.



**Wireless setup is now complete.** A four-level indicator at the top right of your machine's Touchscreen will show the wireless signal strength of your wireless access point/router.



To install the MFL-Pro Suite, continue to step **18**.

For Windows® Users:

**Now go to**  
**page 34**

For Macintosh Users:

**Now go to**  
**page 37**

#### **NOTE**

For mobile device users, see the Advanced Network User's Guides for details on how to use your machine with your mobile device(s). To download the User's Guide for the application you are using, visit the Brother Solutions Center at <http://solutions.brother.com/> and click Manuals on your model's page.



## One-push setup using WPS (Wi-Fi Protected Setup) or AOSS™ (Windows®, Macintosh and mobile devices)

### 17 Configure the wireless settings

**a** Confirm that your wireless access point/router has the WPS or AOSS™ symbol as shown below.



**b** Place the Brother machine within range of your WPS or AOSS™ access point/router. The range may differ depending on your environment (see the instructions provided with your wireless access point/router).

**c** On your machine, press . Press WPS/AOSS.

**d** When `Enable WLAN?` is displayed, press `Yes`. This will start the wireless setup wizard.

**e** When the Touchscreen instructs you to start WPS or AOSS™, press the WPS or AOSS™ button on your wireless access point/router (for more information, see the instructions provided with your wireless access point/router), and then press `OK` on your machine.

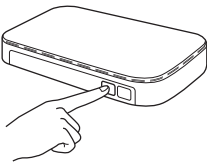

This feature will automatically detect which mode (WPS or AOSS™) your wireless access point/router uses to configure your machine.

#### NOTE

If your wireless access point/router supports WPS and you want to configure your machine using the PIN (Personal Identification Number) Method: >> Network User's Guide: *Configuration using the PIN Method of WPS (Wi-Fi Protected Setup)*.

**f** A connection result message appears on the Touchscreen and a WLAN report will automatically print.

If the connection failed, check the error code on the printed report and refer to *Troubleshooting* >> page 30.

Press `OK`.



**Wireless setup is now complete.** A four-level indicator at the top right of your machine's Touchscreen will show the wireless signal strength of your wireless access point/router.

**To install the MFL-Pro Suite, continue to step 18.**

**For Windows® Users:**

**Now go to page 34**

**For Macintosh Users:**

**Now go to page 37**

#### NOTE

For mobile device users, see the Advanced Network User's Guides for details on how to use your machine with your mobile device(s). To download the User's Guide for the application you are using, visit the Brother Solutions Center at <http://solutions.brother.com/> and click Manuals on your model's page.



## Troubleshooting

### IMPORTANT

If you need assistance during setup and want to contact Brother Customer Service, make sure you have your SSID (Network Name) and Network Key ready. We cannot assist you in locating this information.

### To find the wireless settings (SSID (Network Name) and Network Key)\*

1. Check the documentation provided with your wireless access point/router.
2. The default SSID could be the access point/router manufacturer's name or the model name.
3. If you do not know the security information, please consult the router manufacturer, your system administrator, or your internet provider.

- \* The Network Key may also be described as the Password, Security Key, or Encryption Key.
- \* If the wireless access point/router is set not to broadcast the SSID, the SSID will not be detected automatically. You must manually enter the SSID name (➤➤ Network User's Guide: *Configuring your machine when the SSID is not broadcast*).

### WLAN report

If the printed WLAN report shows that the connection failed, check the error code on the printed report and refer to the following instructions:

Error Code	Recommended Solutions
TS-01	<p>The wireless setting is not activated, turn the wireless setting to ON.</p> <ul style="list-style-type: none"> <li>- If a LAN cable is connected to your machine, disconnect it and turn the wireless setting of your machine to ON.               <ol style="list-style-type: none"> <li>1. On your machine, press .</li> <li>2. Press <code>Network</code>.</li> <li>3. Press <code>WLAN</code>, and then press <code>Setup Wizard</code>.</li> <li>4. When <code>Enable WLAN?</code> is displayed, press <code>Yes</code>. This will start the wireless setup wizard.</li> </ol> </li> </ul>
TS-02	<p>The wireless access point/router cannot be detected.</p> <ul style="list-style-type: none"> <li>- Check the following four points:               <ol style="list-style-type: none"> <li>1. Make sure the wireless access point/router is powered on.</li> <li>2. Move your machine to an obstruction-free area, or closer to the wireless access point/router.</li> <li>3. Temporarily place your machine within about one metre from the wireless access point/router when you are configuring the wireless settings.</li> <li>4. If your wireless access point/router is using MAC address filtering, confirm that the MAC address of the Brother machine is allowed in the filter (see <i>Print the Network Configuration Report</i> ➤➤ page 39).</li> </ol> </li> <li>- If you manually entered the SSID and security information (SSID/authentication method/encryption method/Network Key), the information may be incorrect. Confirm the SSID and security information (see <i>To find the wireless settings (SSID (Network Name) and Network Key)*</i> ➤➤ page 30). Re-enter the correct information, if necessary.</li> </ul>



Error Code	Recommended Solutions												
TS-03	<p>The wireless network and security setting you entered may be incorrect.</p> <p>Confirm that the wireless network settings are correct (see <i>To find the wireless settings (SSID (Network Name) and Network Key)</i>* &gt;&gt; page 30).</p> <p>* Check if the entered or selected SSID/authentication method/encryption method/Network Key are correct.</p>												
TS-04	<p>The Authentication/Encryption methods used by the selected wireless access point/router are not supported by your machine.</p> <p>For infrastructure mode, change the authentication and encryption methods of the wireless access point/router. Your machine supports the following authentication methods WPA™, WPA2™, OPEN and Shared key. WPA supports TKIP or AES encryption methods. WPA2 supports AES for the encryption method. OPEN and Shared key correspond to WEP encryption.</p> <p>If your problem is not solved, the SSID or network settings you entered may be incorrect. Confirm that the wireless network settings are correct (see <i>To find the wireless settings (SSID (Network Name) and Network Key)</i>* &gt;&gt; page 30).</p> <p><b>Combined table of authentication and encryption methods</b></p> <table border="1" data-bbox="331 943 1090 1240"> <thead> <tr> <th>Authentication method</th> <th>Encryption method</th> </tr> </thead> <tbody> <tr> <td rowspan="2">WPA-Personal</td> <td>TKIP</td> </tr> <tr> <td>AES</td> </tr> <tr> <td>WPA2-Personal</td> <td>AES</td> </tr> <tr> <td rowspan="2">OPEN</td> <td>WEP</td> </tr> <tr> <td>NONE (without encryption)</td> </tr> <tr> <td>Shared key</td> <td>WEP</td> </tr> </tbody> </table> <p>For ad-hoc mode, change the authentication and encryption methods of your computer for the wireless setting. Your machine supports OPEN authentication method only, with optional WEP encryption.</p>	Authentication method	Encryption method	WPA-Personal	TKIP	AES	WPA2-Personal	AES	OPEN	WEP	NONE (without encryption)	Shared key	WEP
Authentication method	Encryption method												
WPA-Personal	TKIP												
	AES												
WPA2-Personal	AES												
OPEN	WEP												
	NONE (without encryption)												
Shared key	WEP												
TS-05	<p>The security information (SSID/Network Key) is incorrect.</p> <p>Confirm that the SSID and security information (Network Key) are correct (see <i>To find the wireless settings (SSID (Network Name) and Network Key)</i>* &gt;&gt; page 30).</p> <p>If your router uses WEP encryption, enter the key used as the first WEP key. Your machine supports the use of the first WEP key only.</p>												
TS-06	<p>The wireless security information (Authentication method/Encryption method/Network Key) is incorrect.</p> <p>Confirm the wireless security information as shown in the “Combined table of authentication and encryption methods” table in error TS-04. If your router uses WEP encryption, enter the key used as the first WEP key. Your machine supports the use of the first WEP key only.</p> <p>Confirm the Network Key (see <i>To find the wireless settings (SSID (Network Name) and Network Key)</i>* &gt;&gt; page 30).</p>												

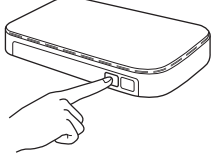

Error Code	Recommended Solutions
TS-07	<p>The machine cannot detect a wireless access point/router that has WPS or AOSS™ enabled.</p> <p>To configure your wireless settings using WPS or AOSS™, you must operate both your machine and the wireless access point/router. Confirm your wireless access point/router supports WPS or AOSS™ and try starting again.</p>  <p>If you do not know how to operate your wireless access point/router using WPS or AOSS™, see the documentation provided with your wireless access point/router, ask the manufacturer of your wireless access point/router, or ask your network administrator.</p>
TS-08	<p>Two or more wireless access points/routers that have WPS or AOSS™ enabled are detected.</p> <ul style="list-style-type: none"><li>- Confirm that only one wireless access point/router within range has WPS or AOSS™ active and try again.</li><li>- Try starting again after a few minutes in order to avoid interference from other wireless access points/routers.</li></ul>





## Entering Text

When you are setting certain menu selections, you may need to enter text into the machine.

Press  repeatedly to choose between letters, numbers and special characters.



Press  to change between upper case and lower case.



### Inserting spaces

To enter a space, press *Space*.

### Making corrections

If you entered a character incorrectly and want to change it, press  or  to move the cursor under the incorrect character, and then press . Enter the correct character.

### NOTE

- The characters available may differ depending on your country.
- The keyboard layout may differ depending on the function you are setting.



## Install the Drivers and Software (Windows® XP/XP Professional x64 Edition/Windows Vista®/ Windows® 7/Windows® 8) (MFC-9330CDW / MFC-9340CDW)

### 18 Before you install

#### IMPORTANT

- If there are any programs running, close them.
- The screens may differ depending on your operating system.

#### NOTE

- The CD-ROM includes Nuance™ PaperPort™ 12SE. This software supports Windows® XP (SP3 or greater), XP Professional x64 Edition (SP2 or greater), Windows Vista® (SP2 or greater), Windows® 7 and Windows® 8. Update to the latest Windows® Service Pack before installing MFL-Pro Suite.
- Disable all personal firewall software (other than Windows® Firewall), anti-spyware, or antivirus applications for the duration of the installation.

- a** Make sure your computer is ON and you are logged on with Administrator rights.

### 19 Install MFL-Pro Suite

- a** Put the CD-ROM into your CD-ROM drive. If the model name screen appears, choose your machine. If the language screen appears, choose your language.

#### NOTE

- If the Brother screen does not appear automatically, go to **Computer (My Computer)**.  
(For Windows® 8: click the  (**File Explorer**) icon on the taskbar, and then go to **Computer**.) Double-click the CD-ROM icon, and then double-click **start.exe**.
- If the **User Account Control** screen appears, click **Continue** or **Yes**.

- b** Click **Install MFL-Pro Suite**, and click **Yes** in the next two windows if you accept the license agreements.

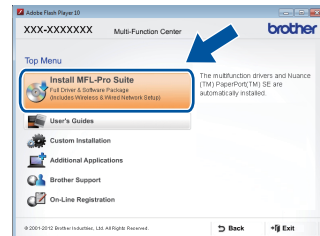

#### NOTE

If the installation does not continue automatically, restart the installation by ejecting and then reinserting the CD-ROM or by double-clicking the **start.exe** program from the root folder. Continue from step **b** to install MFL-Pro Suite.

- c** Choose **Wireless Network Connection**, and then click **Next**.

#### NOTE

To install the PS driver (BR-Script3 printer driver), choose **Custom Install**, and then follow the on-screen instructions.

- d** When the **Firewall/AntiVirus detected** screen appears, choose **Change the Firewall port settings to enable network connection and continue with the installation. (Recommended)** and click **Next**.

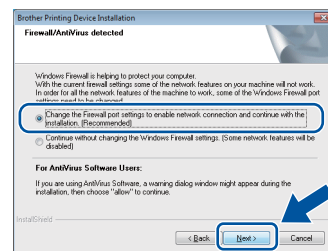

If you are not using the Windows® Firewall, see the user's guide for your software for information on how to add the following network ports:

- For network scanning, add UDP port 54925.
- For network PC-Fax receiving, add UDP port 54926.
- If you still have trouble with your network connection, add UDP ports 161 and 137.



- e Choose the machine from the list, and then click **Next**.

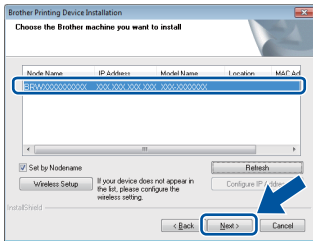

## NOTE

- If your wireless settings fail, click the **Wireless Setup** button and follow the on-screen instructions to complete the wireless configuration.
- If you are using WEP and the Touchscreen displays *Connected* but your machine is not found, make sure you entered the WEP key correctly. The WEP key is case-sensitive.

- f The installation will automatically continue. The installation screens appear one after another. If prompted, follow any on-screen instructions.

## IMPORTANT

DO NOT cancel any of the screens during the installation. It may take a few minutes for all screens to appear.

## NOTE

If the **Windows Security** screen appears, select the check box and click **Install** to complete the installation correctly.

- g When the **On-Line Registration** screen appears, make your selection and follow the on-screen instructions. Once you have completed the registration process, click **Next**.

- h When the **Setup is Complete** screen appears, make your selection, and then click **Next**.

## 20 Finish and restart

- a Click **Finish** to restart your computer. After restarting the computer, you must log on with Administrator rights.

## NOTE

- If an error message appears during the software installation, do one of the following:
  - For Windows® XP, Windows Vista® and Windows® 7 users: run the **Installation Diagnostics** located in (**Start**) > **All Programs > Brother > MFC-XXXX LAN** (where MFC-XXXX is your model name).
  - For Windows® 8 users: to run **Installation Diagnostics**, double-click the (**Brother Utilities**) icon on the desktop, and then click the drop-down list and select your model name (if not already selected). Click **Tools** in the left navigation bar.
- Depending on your security settings when using the machine or its software, a Windows® Security or antivirus software window may appear. Please allow or permit the window to continue.

## 21 Install MFL-Pro Suite on additional computers (if needed)

If you want to use your machine with multiple computers on the network, install MFL-Pro Suite on each computer. Go to step **18** on page 34.

## NOTE

### Network license (Windows®)

This product includes a PC license for up to five users. This license supports the installation of the MFL-Pro Suite including Nuance™ PaperPort™ 12SE on up to five PCs on the network. If you want to use more than five PCs with Nuance™ PaperPort™ 12SE installed, please purchase the Brother NL-5 pack which is a multiple PC license agreement pack for up to five additional users. To purchase the NL-5 pack, contact your authorized Brother dealer or contact Brother customer service.



## Finish

The installation is now complete.

### NOTE

- For Windows® 8 users: if the Brother manuals included on the CD-ROM are in PDF format, use Adobe® Reader® to open them. If Adobe® Reader® is installed on your computer but cannot open the files in Adobe® Reader®, change the file association for PDF (see *How to open a PDF file in Adobe® Reader® (Windows® 8)* >> page 40).
- **XML Paper Specification Printer Driver**  
The XML Paper Specification Printer Driver is the most suitable driver for Windows Vista®, Windows® 7 and Windows® 8 when printing from applications that use the XML Paper Specification. Please download the latest driver from the Brother Solutions Center at <http://solutions.brother.com/>.



## Install the Drivers and Software (Mac OS X v10.6.8, 10.7.x, 10.8.x) (MFC-9330CDW / MFC-9340CDW)

### 18 Before you install

#### IMPORTANT

For Mac OS X v10.6.7 or lower users: upgrade to Mac OS X v10.6.8, 10.7.x, 10.8.x. (For the latest drivers and information for the Mac OS X you are using, visit [http://solutions.brother.com/.](http://solutions.brother.com/))

- a Make sure your machine is connected to an AC power source and your Macintosh is ON. You must be logged on with Administrator rights.

### 19 Install MFL-Pro Suite

- a Put the CD-ROM into your CD-ROM drive, and then double-click the **BROTHER** icon on your desktop.
- b Double-click the **Start Here OSX** icon. If prompted, select your model.



- c Choose **Wireless Network Connection**, and then click **Next**.

#### NOTE

If your wireless settings fail, the **Wireless Device Setup Wizard** screen appears. Follow the on-screen instructions to complete the wireless configuration.

- d Choose your machine from the list, and then click **Next**.

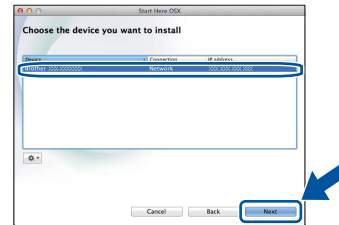

#### NOTE

- If there is more than one of the same model connected on your network, the IP Address will be displayed to help you identify the machine.
- You can find your machine's IP Address by printing out the Network Configuration Report (see *Print the Network Configuration Report* >> page 39).

- e The installation screens appear one after another. If prompted, follow any on-screen instructions.

#### IMPORTANT

DO NOT cancel any of the screens during the installation. It may take a few minutes for the installation to complete.

#### NOTE

If the **Setup Network "Scan to" name** screen appears, follow the instructions below:

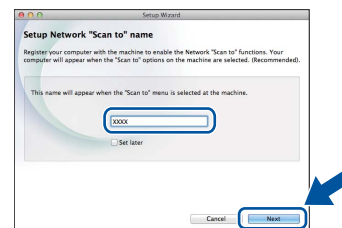

- 1) Enter a name for your Macintosh (up to 15 characters long).
- 2) Click **Next**. Go to **f**.

The name you enter will appear on the machine's Touchscreen when you press the **Scan** button and choose a scan option (for more information: >> *Software User's Guide*).



**f** When the **Add Printer** screen appears, click **Add Printer**.

**g** Choose your machine from the list, click **Add**, and then click **Next**.

(OS X v10.8.x)

Select **MFC-XXXX CUPS** driver from the **Use** pop-up menu (where XXXX is your model name).

## NOTE

To add the PS driver (BR-Script3 printer driver), select it from the **Print Using (Use)** pop-up menu.



The installation of MFL-Pro Suite is now complete.  
Go to step 20 on page 38.

## 20 Download and install Presto! PageManager

When Presto! PageManager is installed, OCR capability is added to Brother ControlCenter2. You can easily scan, share and organize photos and documents using Presto! PageManager.

**a** On the **Brother Support** screen, click **Presto! PageManager** and follow the on-screen instructions.

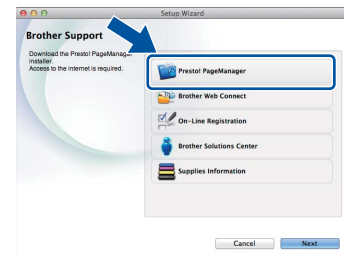

## 21 Install MFL-Pro Suite on additional computers (if needed)

If you want to use your machine with multiple computers on the network, install MFL-Pro Suite on each computer. Go to step 18 on page 37.

**Finish**

The installation is now complete.

## Web Based Management (web browser)

The Brother print server is equipped with a web server that allows you to monitor its status or change some of its configuration settings using HTTP (Hypertext Transfer Protocol).

### NOTE

We recommend Windows® Internet Explorer® 8.0/9.0 for Windows® and Safari 5.0 for Macintosh. Please also make sure JavaScript and cookies are always enabled in whichever browser you use. To use a web browser, you will need to know the IP address of the print server, which is listed on the Network Configuration Report.

- a** Open your browser.
- b** Type “http://machine’s IP address/” into your browser’s address bar (where “machine’s IP address” is the IP address of the Brother machine or the print server name).
  - For example: http://192.168.1.2/

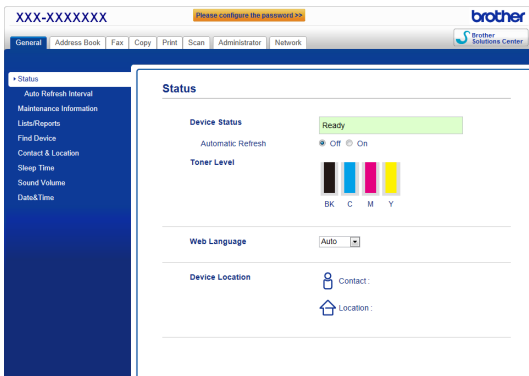

### NOTE

If you have configured an optional login password, you must enter it when prompted to access the Web Based Management.

 For more information: >> Network User's Guide: *Web Based Management*.

## Print the Network Configuration Report

You can print the Network Configuration Report to confirm the current network settings.

- a** Press .
- b** Press `All Settings`.
- c** Swipe up or down, or press ▲ or ▼ to display `Print Reports`.  
Press `Print Reports`.
- d** Swipe up or down, or press ▲ or ▼ to display `Network Configuration`.  
Press `Network Configuration`.
- e** Press `OK`.  
The machine will print the current network settings.

## Restore the network settings to the factory default

You can restore all network settings of the internal Print/Scan server to the factory default.

- a** Press .
- b** Press `All Settings`.
- c** Swipe up or down, or press ▲ or ▼ to display `Network`.  
Press `Network`.
- d** Swipe up or down, or press ▲ or ▼ to display `Network Reset`.  
Press `Network Reset`.
- e** Press `Yes`.
- f** Press `Yes` for two seconds.  
The machine will restart. Disconnect the cables, and after the machine has restarted, reconnect the cables.

## Colour Correction

The output density and print position of each colour may vary depending on the machine's environment. Factors like temperature and humidity can affect colour. Colour calibration and colour registration help you to improve the colour density and the print position of each colour.



## Colour Calibration

Calibration helps you to improve the colour density.

### NOTE

- If you print using the Direct Print feature (MFC-9330CDW / MFC-9340CDW) or the BR-Script printer driver, you need to perform the calibration from the control panel (see *Using the control panel* >> page 40).
- If you print using the Windows® printer driver, the driver will get the calibration data automatically if both **Use Calibration Data** and **Get Device Data Automatically** are on (>> *Software User's Guide*).
- If you print using the Macintosh printer driver, the driver will get the calibration data automatically.



## Using the control panel

- Press  (Toner).
- Press **Calibration**.
- Press **Calibrate**.
- Press **Yes**.
- Press .

## Colour Registration

### Auto Registration

Auto registration helps you to improve the print position of each colour.

- Press  (Toner).
- Press **Auto Regist..**
- Press **Yes**.
- Press .

## How to open a PDF file in Adobe® Reader® (Windows® 8)

- Move your mouse to the lower right corner of your desktop. When the menu bar appears, click **Settings**, and then click **Control Panel**.
- Click **Programs**, click **Default Programs**, and then click **Associate a file type or protocol with a program**.
- Select **.pdf**, and then click on the **Change program...** button.
- Click **Adobe Reader**. The icon next to **.pdf** changes to the '**Adobe Reader**' icon.  
Adobe® Reader® is now the default application for reading .pdf files until you change this file association.

## Brother CreativeCenter



Get inspired. If you're using Windows®, double-click the Brother CreativeCenter icon on your desktop to access our FREE website with many ideas and resources for personal and professional use.

For Windows® 8 users: click  (**Brother Utilities**), and then click the drop-down list and select your model name (if not already selected). Click **Use More** in the left navigation bar, and then click **Brother Creative Center**.



Mac users can access Brother CreativeCenter at this web address:

<http://www.brother.com/creativecenter/>



## Consumables

When the time comes to replace consumable items such as toner or drums, an error message will appear on your machine's Touchscreen. For more information about the consumables for your machine, visit us at <http://www.brother.com/original/> or contact your local Brother reseller.

### NOTE

The drum unit and toner cartridge are two separate parts.

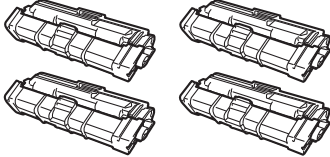
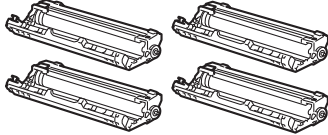
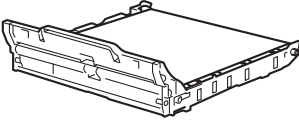
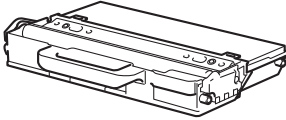
Toner Cartridges	Drum Units
Standard Toner: TN-241 (C/M/Y/BK) High Yield Toner: TN-245 (C/M/Y)	DR-241CL
	
Belt Unit	Waste Toner Box
BU-220CL	WT-220CL
	



For more information on replacing the consumable items: ►► Basic User's Guide: *Replacing the consumable items.*

## Trademarks

The Brother logo is a registered trademark of Brother Industries, Ltd.

Brother is a trademark of Brother Industries, Ltd.

Microsoft, Windows, Windows Vista, Windows Server and Internet Explorer are either registered trademarks or trademarks of Microsoft Corporation in the United States and/or other countries.

Apple, Macintosh, Safari and Mac OS are trademarks of Apple Inc., registered in the U.S. and other countries.

Linux is the registered trademark of Linus Torvalds in the U.S. and other countries.

Adobe and Reader are either registered trademarks or trademarks of Adobe Systems Incorporated in the United States and/or other countries.

Wi-Fi Direct, Wi-Fi Protected Setup (WPS), WPA and WPA2 are marks of the Wi-Fi Alliance.

AOSS is a trademark of Buffalo Inc.

Android is a trademark of Google Inc.

Nuance, the Nuance logo, PaperPort and ScanSoft are trademarks or registered trademarks of Nuance Communications, Inc. or its affiliates in the United States and/or other countries.

Each company whose software title is mentioned in this manual has a Software License Agreement specific to its proprietary programs.

**Any trade names and product names of companies appearing on Brother products, related documents and any other materials are all trademarks or registered trademarks of those respective companies.**

## Compilation and Publication

Under the supervision of Brother Industries, Ltd., this manual has been compiled and published, covering the latest product descriptions and specifications.

The contents of this manual and the specifications of this product are subject to change without notice.

Brother reserves the right to make changes without notice in the specifications and materials contained herein and shall not be responsible for any damages (including consequential) caused by reliance on the materials presented, including but not limited to typographical and other errors relating to the publication.

## Copyright and License

©2012 Brother Industries, Ltd. All rights reserved.

This product includes software developed by the following vendors:

©1983-1998 PACIFIC SOFTWARES, INC. ALL RIGHTS RESERVED.

©2008 Devicescape Software, Inc. All rights reserved.

This product includes the "KASAGO TCP/IP" software developed by ZUKEN ELMIC, Inc.



[www.brotherearth.com](http://www.brotherearth.com)

**brother**®