

brother®

# Advanced User's Guide

FAX-2840  
FAX-2950  
MFC-7240  
MFC-7290

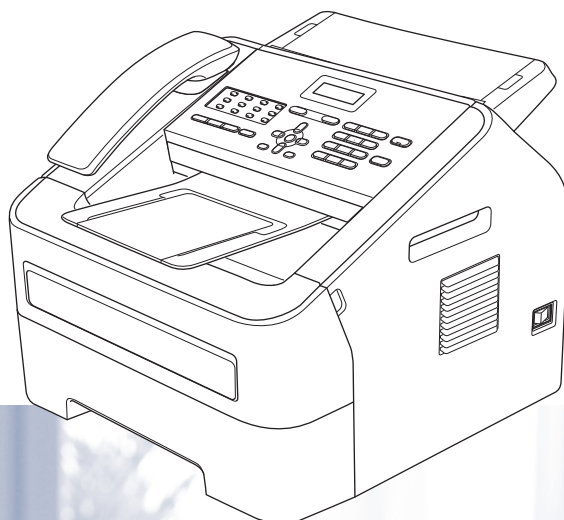

Not all models are available in all countries.

Version 0  
ARL/ASA/NZ

## User's Guides and where do I find them?

Which Guide?	What's in it?	Where is it?
<b>Product Safety Guide</b>	Read this Guide first. Please read the Safety Instructions before you set up your machine. See this Guide for trademarks and legal limitations.	Printed / In the Box
<b>Quick Setup Guide</b>	Follow the instructions for setting up your machine and installing the drivers and software for the operating system (for FAX-2950, MFC-7240 and MFC-7290) and connection type you are using.	Printed / In the Box
<b>Basic User's Guide</b>	Learn the basic Fax, Copy and Scan (for FAX-2950, MFC-7240 and MFC-7290) operations and how to replace consumables. See troubleshooting tips.	Printed / In the Box
<b>Advanced User's Guide</b>	Learn more advanced operations: Fax, Copy, security features, printing reports and performing routine maintenance.	PDF file / CD-ROM / In the Box
<b>Software User's Guide</b> (For FAX-2950, MFC-7240 and MFC-7290)	Follow these instructions for Printing, Scanning, Remote Setup, PC-Fax and using the Brother ControlCenter utility.	PDF file / CD-ROM / In the Box

## Download optional software from the Brother Solutions Center (FAX-2840 users only)

You can download a printer driver for free from the Brother Solutions Center, enabling you to use your Brother Fax machine as a printer. Visit us at <http://solutions.brother.com/>.

# Table of Contents

<b>1</b>	<b>General Setup</b>	<b>1</b>
	IMPORTANT NOTE.....	1
	Memory Storage .....	1
	Set Daylight Saving Time .....	2
	Ecology features .....	2
	Toner Save .....	2
	Sleep mode .....	2
	Deep Sleep mode.....	3
	Toner Settings .....	3
	Toner Setting (Continue mode) .....	3
	Receiving faxes in Continue Mode .....	4
	Toner End in Continue Mode.....	4
	LCD Contrast.....	4
	Mode Timer.....	5
	Dial Prefix .....	5
	Setting up the prefix number .....	5
	Changing the prefix number .....	6
<b>2</b>	<b>Security features</b>	<b>7</b>
	Security.....	7
	TX Lock	
	(FAX-2840 and MFC-7240).....	7
	Memory Security	
	(FAX-2950 and MFC-7290).....	8
	Setting Lock.....	9
	Restricting dialling .....	10
<b>3</b>	<b>Sending a fax</b>	<b>11</b>
	Additional sending options.....	11
	Sending faxes using multiple settings .....	11
	Contrast .....	11
	Changing Fax Resolution .....	12
	Additional sending operations.....	13
	Sending a fax manually .....	13
	Dual access .....	13
	Broadcasting.....	13
	Real Time Transmission.....	14
	Overseas Mode .....	15
	Delayed Fax .....	15
	Delayed batch transmission .....	15
	Checking and cancelling waiting jobs.....	15
	Electronic cover page .....	16
	Polling overview.....	18
	Polled transmit.....	18
<b>4</b>	<b>Receiving a fax</b>	<b>19</b>

Remote Fax Options .....	19
Fax Forwarding.....	19
Fax Storage .....	19
Changing Remote Fax Options .....	19
Remote retrieval .....	20
Remote fax commands.....	23
Additional receiving operations.....	24
Printing a reduced incoming fax .....	24
Setting the Fax Receive Stamp .....	24
Receiving faxes into memory (FAX-2840 and MFC-7240).....	24
Setting the Print Density .....	25
Printing a fax from the memory .....	25
Out of Paper Reception .....	25
Polling overview.....	26
Polling receive .....	26
Stop polling.....	27
<b>5 Dialling and storing numbers</b> .....	<b>28</b>
Telephone line services .....	28
Caller ID.....	28
Additional dialling operations .....	29
Combining quick dial numbers .....	29
Additional ways to store numbers.....	29
Setting up Groups for Broadcasting .....	29
Changing Group numbers .....	30
Deleting Group numbers .....	31
<b>6 Printing reports</b> .....	<b>32</b>
Fax reports.....	32
Transmission verification report.....	32
Fax Journal.....	32
Reports .....	33
How to print a report.....	33
<b>7 Making copies</b> .....	<b>34</b>
Copy settings .....	34
Stop copying.....	34
Using the Options key .....	35
Improving copy quality.....	37
Sorting copies using the ADF .....	37
Adjusting Contrast and Brightness .....	37
Enlarging or reducing the image copied .....	38
Making N in 1 copies (page layout) .....	39
Manual Duplex (two-sided) Copying.....	39
<b>A Routine maintenance</b> .....	<b>41</b>
Cleaning the machine .....	41
Checking the machine .....	41

Checking the Page Counters.....	41
Checking the remaining life of parts .....	41
Packing and shipping the machine .....	42

---

<b>B</b>	<b>Glossary</b>	<b>44</b>
----------	-----------------	-----------

---

<b>C</b>	<b>Index</b>	<b>48</b>
----------	--------------	-----------

---

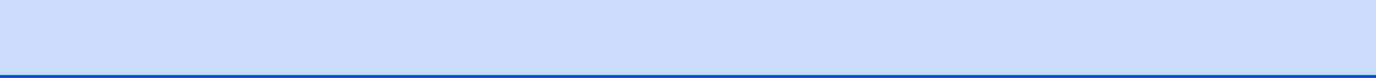

## IMPORTANT NOTE

- Most of the illustrations in this User's Guide show the FAX-2840.

## Memory Storage

Your menu settings are stored permanently, and in the event of a power failure will *not* be lost. Temporary settings (for example, Contrast and Overseas Mode) *will* be lost.

(For FAX-2950 and MFC-7290)

During a power failure the machine will retain the date and time and programmed fax timer jobs (e.g. Delayed Fax) for approximately 60 hours. Other fax jobs in the machine's memory will not be lost.

(For FAX-2840 and MFC-7240)

During a power failure the machine will retain the date and time for approximately 2 hours. The fax jobs in the machine's memory will be lost.

## Set Daylight Saving Time

You can set the machine to change for Daylight Saving Time. If you choose **On**, it will reset the time forward one hour, and if you choose **Off**, it will reset the time backward one hour.

- 1 Press **Menu, 0, 2, 2**.
- 2 Press **▲** or **▼** to choose **On** or **Off**. Press **OK**.
- 3 Press **1** or **2** to choose **1.Change** or **2.Exit**.
- 4 Press **Stop/Exit**.

## Ecology features

### Toner Save

---

You can save toner using this feature. When you set Toner Save to **On**, prints appear lighter. The default setting is **Off**.

- 1 Press **Menu, 1, 4, 1**.
- 2 Press **▲** or **▼** to choose **On** or **Off**. Press **OK**.
- 3 Press **Stop/Exit**.



#### Note

---

We do not recommend Toner Save for printing Photos or Greyscale images.

---

### Sleep mode

---

The Sleep Time setting can reduce power consumption. When the machine is in Sleep mode (Power Save mode) it acts as though it were turned off. Receiving data or starting an operation wakes the machine up from Sleep mode to Ready mode.

You can choose how long the machine must be idle before it goes into sleep mode. When the machine receives a fax, computer data or makes a copy, the timer will be reset. The default setting is 3 minutes.

While the machine is in sleep mode the LCD will show **Sleep**.

- 1 Press **Menu, 1, 4, 2**.
- 2 Enter the length of time the machine is idle before entering sleep mode. Press **OK**.
- 3 Press **Stop/Exit**.



## Deep Sleep mode

---

If the machine is in Sleep mode and does not receive any jobs for a certain length of time, the machine will automatically enter Deep Sleep mode, and the LCD will show `Deep Sleep`. Deep Sleep mode uses less power than Sleep mode. The machine will wake up and start warming up when the machine receives computer data or when you press a key on the control panel.

Lifting the handset will also wake up the machine from Deep Sleep mode.

## Toner Settings

### Toner Setting (Continue mode)

---

You can set the machine to continue printing after the LCD shows `Replace Toner`. The machine will continue printing until the LCD shows `Toner Ended`. The default setting is `Stop`.

- 1 Press **Menu**, **1**, **7**.
- 2 Press **▲** or **▼** to choose `Continue` or `Stop`. Press **OK**.
- 3 Press **Stop/Exit**.



#### Note

---

- If you continue printing in the Continue mode, we cannot guarantee the print quality.
  - While using Continue mode the print may appear faint.
  - After replacing the toner cartridge with a new one, the Continue mode will go back to the default setting (`Stop`).
-

## Receiving faxes in Continue Mode

---

The machine can store received faxes in the memory if you choose Continue mode when the LCD shows `Replace Toner`. When received faxes are printed in Continue mode the LCD will ask if the print quality of the fax is OK. If the quality is not good, choose `2.No.` The machine will keep the faxes stored in the memory so you can reprint them after you replace the toner cartridge with a new one. If the print quality is good, choose `1.Yes.` The LCD will ask if you want to delete the printed faxes from the memory. If you choose not to delete them, you will be asked again after you replace the toner cartridge with a new one.



### Note

---

- The FAX-2840 and MFC-7240 can store up to 400 faxes in memory and the FAX-2950 and MFC-7290 can store up to 500 faxes in memory.
- (FAX-2840 and MFC-7240)  
If you turn off the power switch faxes stored in memory will be lost.
- The machine will keep faxes stored in Continue Mode even if you change the `Continue` setting to `Stop`.
- If you install a new toner cartridge when the LCD shows `Toner Ended`, the machine will ask if you want to print the stored faxes. Choose `1.Print` to print stored faxes.

## Toner End in Continue Mode

---

When the LCD shows `Toner Ended` the machine will stop printing. If the memory is full and you want to continue receiving faxes, you must install a new toner cartridge.

## LCD Contrast

You can change the contrast to make the LCD look lighter or darker.

- 1 Press **Menu**, **1**, **5**.
- 2 Press **▶** to make the LCD darker. Or, press **◀** to make the LCD lighter. Press **OK**.
- 3 Press **Stop/Exit**.

## Mode Timer

The machine has two or three mode keys on the control panel: **FAX**, **SCAN** (for FAX-2950, MFC-7240 and MFC-7290) and **COPY**.

You can set how much time the machine takes after the last Copy or Scan operation to return to FAX mode default. If you choose **Off**, the machine will stay in the mode you used last.

### FAX-2950, MFC-7240 and MFC-7290



### FAX-2840

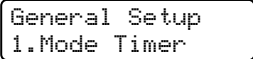

- 1 Press **Menu, 1, 1**.  

- 2 Press **▲** or **▼** to choose 0 Sec, 30 Secs, 1 Min, 2 Mins, 5 Mins or Off. Press **OK**.
- 3 Press **Stop/Exit**.

## Dial Prefix

The Dial Prefix setting will automatically dial a predefined number before every fax number you dial. For example: If your telephone system requires a 9 to dial an outside number use this setting to automatically dial 9 for every fax you send.

### Setting up the prefix number

- 1 Press **Menu, 0, 6**.  
(For New Zealand) Press **Menu, 0, 5**.
- 2 Enter the prefix number (up to 5 digits) on the dial pad. Press **OK**.



#### Note

- You can use the numbers 0 to 9, #, \* and !. (Press **Hook/Hold** to display "!".) You cannot use ! with any other numbers or characters.  
If your telephone system requires a timed break recall (hookflash), press **Hook/Hold** to enter the break.
- (Not available in New Zealand) If the pulse dialing mode is on, # and \* are not available to use.

- 3 Press **Stop/Exit**.

## Changing the prefix number

---

- 1 Press **Menu, 0, 6**.  
(For New Zealand) Press **Menu, 0, 5**.
- 2 Do one of the following:
  - To change the prefix number, press **1**.
  - To exit without making a change, press **2**. Go to step 4.
- 3 Enter a new prefix number using the dial pad (up to 5 digits), press **OK**.
- 4 Press **Stop/Exit**.

## Security

You can set up your machine with multiple levels of security using TX Lock (for FAX-2840 and MFC-7240), Memory Security (for FAX-2950 and MFC-7290) and Setting Lock.

### TX Lock (FAX-2840 and MFC-7240)



#### Note

(For FAX-2840)

You can download the printer driver from the Brother Solutions Center at <http://solutions.brother.com/>.

TX Lock lets you prevent unauthorized access to the machine. You will not be able to continue to schedule Delayed Faxes or Polling jobs. However, any prescheduled Delayed Faxes will be sent even if you turn on TX Lock, so they will not be lost.

While TX Lock is on, the following operations are available:

- Receiving telephone calls
- Receiving faxes
- Fax Forwarding  
(if Fax Forwarding was already on)
- Remote Retrieval  
(if Fax Storage was already on)
- PC Fax Receive (MFC-7240 only)  
(if PC Fax Receive was already on)

While TX Lock is on, the following operations are NOT available:

- Making telephone calls using the machine's handset
- Sending faxes
- Copying
- PC printing (MFC-7240 only)

- Scanning (MFC-7240 only)



#### Note

- To print the faxes in memory, turn off TX Lock.
- If you forget the TX Lock password, please call Brother Customer Service or your local Brother dealer.

### Setting up the password



#### Note

If you have already set the password, you will not need to set it again.

- 1 Press **Menu, 1, 6, 1**.
- 2 Enter a four-digit number for the password using numbers 0-9. Press **OK**.
- 3 If you are entering the password for the first time, the LCD will show *Verify:.*
- 4 Re-enter the password. Press **OK**.
- 5 Press **Stop/Exit**.

### Changing the TX Lock password

- 1 Press **Menu, 1, 6, 1**.
- 2 Press **▲** or **▼** to choose *Set Password*. Press **OK**.
- 3 Enter the registered four-digit password. Press **OK**.
- 4 Enter a four-digit number for the new password. Press **OK**.
- 5 If the LCD shows *Verify:.*, re-enter the new password. Press **OK**.

- 6 Press **Stop/Exit**.

### Turning TX Lock on/off

If you enter the wrong Password, the LCD shows `Wrong Password` and stays offline. The machine will stay in TX Lock Mode until the registered password is entered.

#### Turning TX Lock on

- 1 Press **Menu**, **1**, **6**, **1**.
- 2 Press **▲** or **▼** to choose `Set TX Lock`. Press **OK**.
- 3 Enter the registered four-digit password. Press **OK**.  
The machine goes offline and the LCD shows `TX Lock Mode`.

#### Turning TX Lock off

- 1 Press **Menu**.  
Enter the registered four-digit password.
- 2 Press **OK**.  
TX Lock is automatically turned off.

## Memory Security (FAX-2950 and MFC-7290)

Memory Security lets you prevent unauthorized access to the machine. You will not be able to continue to schedule Delayed Faxes or Polling jobs. However, any pre-scheduled Delayed Faxes will be sent even if you turn on Memory Security, so they will not be lost.

While Memory Security is on, the following operations are available:

- Receiving faxes into memory (limited by memory capacity)
- FAX Forwarding (if Fax Forwarding was already on)
- Remote Retrieval (if Fax Storage was already on)

While Memory Security is on, the following operations are NOT available:

- Printing received faxes
- Sending faxes
- Receiving telephone calls using the machine's handset
- Making telephone calls using the machine's handset
- Copying
- Scanning
- PC printing
- PC Fax Receive
- Operation from control panel



#### Note

To print the faxes in memory, turn off Memory Security.

### Setting up the password



#### Note

- If you have already set the password, you will not need to set it again.
- If you forget the Memory Security password, please call Brother Customer Service or your local Brother dealer.

- 1 Press **Menu**, **1**, **6**, **1**.
- 2 Enter a four-digit number for the password using numbers 0-9. Press **OK**.
- 3 Re-enter the password when the LCD shows `Verify:`. Press **OK**.
- 4 Press **Stop/Exit**.

### Changing your memory security password

- 1 Press **Menu**, **1**, **6**, **1**.

- 2 Press ▲ or ▼ to choose `Set Password`. Press **OK**.
- 3 Enter the registered four-digit password. Press **OK**.
- 4 Enter a four-digit number for the new password. Press **OK**.
- 5 If the LCD shows `Verify:`, re-enter the new password. Press **OK**.
- 6 Press **Stop/Exit**.

### Turning memory security on

- 1 Press **Menu, 1, 6, 1**.
- 2 Press ▲ or ▼ to choose `Set Security`. Press **OK**.
- 3 Enter the registered four-digit password. Press **OK**.  
The machine goes offline and the LCD shows `Secure Mode`.

### Turning memory security off

- 1 Press **Menu**.
- 2 Enter the registered four-digit password. Press **OK**.  
Memory Security is automatically turned off and the LCD shows the date and time.

## Setting Lock

---

Setting Lock lets you set a password to stop other people from accidentally changing your machine settings.

Make a careful note of your password. If you forget it, you will have to reset the passwords stored in the machine. Please call your administrator, Brother Customer Service or your local Brother dealer.

While Setting Lock is `On`, you cannot change the settings without a password. You can only change the following Fax transmission settings that are in the FAX menu.

- Contrast
- Fax Resolution
- Delayed Fax
- Real Time TX
- Polled TX
- Overseas Mode

(For FAX-2950, MFC-7240 and MFC-7290)  
Also, machine settings cannot be changed through the Remote Setup while Setting Lock is `On`.

### Setting up the password

- 1 Press **Menu, 1, 6, 2**.
- 2 Enter a four-digit number for the password using numbers 0-9. Press **OK**.
- 3 Re-enter your password when the LCD shows `Verify:`. Press **OK**.
- 4 Press **Stop/Exit**.

### Changing your Setting Lock password

- 1 Press **Menu, 1, 6, 2**.
- 2 Press ▲ or ▼ to choose `Set Password`. Press **OK**.
- 3 Enter your four-digit password. Press **OK**.
- 4 Enter a four-digit number for the new password. Press **OK**.
- 5 Re-enter your new password when the LCD shows `Verify:`. Press **OK**.
- 6 Press **Stop/Exit**.

## Turning Setting Lock on/off

If you enter the wrong password when following the instructions below, the LCD will show **Wrong Password**. Re-enter the correct password.

### Turning Setting Lock on

- 1 Press **Menu, 1, 6, 2**.
- 2 Press **▲** or **▼** to choose **On**. Press **OK**.
- 3 Enter your four-digit password. Press **OK**.
- 4 Press **Stop/Exit**.

### Turning Setting Lock off

- 1 Press **Menu, 1, 6, 2**.
- 2 Enter your four-digit password. Press **OK** twice.
- 3 Press **Stop/Exit**.

## Restricting dialling

This feature is to prevent users from sending a fax or call to a wrong number by mistake. You can set the machine to restrict dialling by using the dial pad, One Touch and Speed Dial.

If you choose **Off**, the machine does not restrict the dialling method.

If you choose **Enter # twice**, the machine will prompt you to re-enter the number, and then if you re-enter the same number correctly, the machine will start dialling. If you re-enter the wrong number, the LCD will show an error message.

If you choose **On**, the machine will restrict all fax sending and outbound calls for that dialling method.

## Dial pad restriction

- 1 Press **Menu, 2, 6, 1**.
- 2 Press **▲** or **▼** to choose **Off**, **Enter # twice** or **On**. Press **OK**.
- 3 Press **Stop/Exit**.

## One Touch restriction

- 1 Press **Menu, 2, 6, 2**.
- 2 Press **▲** or **▼** to choose **Off**, **Enter # twice** or **On**. Press **OK**.
- 3 Press **Stop/Exit**.

## Speed Dial restriction

- 1 Press **Menu, 2, 6, 3**.
- 2 Press **▲** or **▼** to choose **Off**, **Enter # twice** or **On**. Press **OK**.
- 3 Press **Stop/Exit**.



### Note

- The **Enter # twice** setting will not work if you lift a machine's handset or press **Hook/Hold** before entering the number.
- The Restricting dialling feature will not work if you use an external handset or an extension handset.
- The machine cannot restrict dialling when you use the **Redial/Pause** button.
- If you chose **On** or **Enter # twice**, you cannot use the Broadcasting feature and cannot combine quick dial numbers when dialling.



# 3

## Sending a fax

### Additional sending options

#### Sending faxes using multiple settings

Before you send a fax, you can change any combination of these settings: contrast, resolution, overseas mode, delayed fax timer, polling transmission, real time transmission or cover page settings.

- 1 Make sure you are in FAX mode . After each setting is accepted, the LCD asks if you want to enter more settings.

```
Next
1.Yes 2.No
```

- 2 Do one of the following:
  - To choose more settings, press **1**. The LCD returns to the `Setup Send` menu so you can choose another setting.
  - If you have finished choosing settings, press **2** and go to the next step for sending your fax.

#### Contrast

For most documents the default setting of `Auto` will give the best results. It automatically chooses the suitable contrast for your document.

If your document is very light or dark, changing the contrast may improve the quality of the fax.

Use `Dark` to make the faxed document lighter.

Use `Light` to make the faxed document darker.

- 1 Make sure you are in FAX mode .
- 2 Load your document.
- 3 Press **Menu**, **2**, **2**, **1**.
- 4 Press **▲** or **▼** to choose `Auto`, `Light` or `Dark`. Press **OK**.



#### Note

Even if you choose `Light` or `Dark`, the machine will send the fax using the `Auto` setting if you choose `Photo` as the Fax Resolution.

## Changing Fax Resolution

The quality of a fax can be improved by changing the Fax Resolution. Resolution can be changed for the next fax or for all faxes.

### To change the Fax Resolution setting for the *next* fax

- 1 Make sure you are in FAX mode .
- 2 Load your document.
- 3 Press **Resolution**, then ▲ or ▼ to choose the resolution.  
Press **OK**.

### To change the default Fax Resolution setting

- 1 Make sure you are in FAX mode .
- 2 Press **Menu, 2, 2, 2**.
- 3 Press ▲ or ▼ to choose the resolution you want.  
Press **OK**.



#### Note

You can choose four different resolution settings.

fax resolution	
Standard	Suitable for most typed documents.
Fine	Good for small print and transmits a little slower than Standard resolution.
S.Fine	Good for small print or artwork and transmits slower than Fine resolution.
Photo	Use when the document has varying shades of grey or is a photograph. This has the slowest transmission time.

The time taken to send will increase when selecting *S.Fine* or *Photo*.

## Additional sending operations

### Sending a fax manually

#### Manual transmission

Manual transmission lets you hear the dialling, ringing and fax-receiving tones while sending a fax.

- 1 Make sure you are in FAX mode .
- 2 Load your document.
- 3 Press **Hook/Hold** or pick up the handset of the machine and listen for a dial tone.
- 4 Dial the fax number you want to call.
- 5 When you hear the fax tone, press **Start**.
- 6 Press **Hook/Hold** or replace the machine's handset.

### Dual access

You can dial a number and start scanning the fax into memory—even when the machine is sending from memory, receiving faxes or printing PC data. The LCD will show the new job number.

The number of pages you can scan into the memory will vary depending on the data that is printed on them.

#### Note

If you get an **Out of Memory** message while scanning the first page of a fax, press **Stop/Exit** to cancel scanning. If you get an **Out of Memory** message while scanning a subsequent page, you can press **Start** to send the pages scanned so far, or press **Stop/Exit** to cancel the operation.

## Broadcasting

Broadcasting lets you send the same fax message to more than one fax number. You can include Groups, One Touch, Speed Dial numbers and up to 50 manually dialled numbers in the same broadcast.

You can broadcast up to 272 different numbers. This will depend on how many Groups, access codes or credit card numbers you have stored, and on how many delayed or stored faxes in memory.

### Before you begin the broadcast

One Touch and Speed Dial numbers must be stored in the machine's memory before they can be used in a broadcast. (See Basic User's Guide: *Storing One Touch Dial numbers* and *Storing Speed Dial numbers*.)

Group numbers must also be stored in the machine's memory before they can be used in a broadcast. Group numbers include many stored One Touch Dial and Speed Dial numbers for easier dialling. (See *Setting up Groups for Broadcasting* >> page 29.)

### How to broadcast a fax



#### Note

Use  (**Address Book**) to help you choose numbers easily.

- 1 Make sure you are in FAX mode .
- 2 Load your document.
- 3 Enter a number.  
Press **OK**.  
You can use either a One Touch, Speed Dial, a Group number, or a number manually entered using the dial pad. (See Basic User's Guide: *How to dial*.)
- 4 Repeat step 3 until you have entered all the fax numbers you want to broadcast to.

### 5 Press **Start**.

After the broadcast is finished the machine will print a broadcast report to let you know the results.

### Canceling a Broadcast in progress

While broadcasting you can cancel the fax currently being sent or the whole broadcast job.

#### 1 Press **Menu, 2, 7**.

The LCD will display the Broadcast job number followed by the fax number being dialled (for example, #001 123456789) and the broadcast job number (for example, Broadcast#001).

#### 2 Press **▲** or **▼** to choose one of the following:

- Choose the fax number being dialled, and press **OK**.
- Choose the broadcast job number, and press **OK**.

#### 3 Press **1** to cancel the fax number or Broadcast job number you chose in step 2, or press **2** to exit without cancelling.

- If you chose to only cancel the fax currently being sent in step 2, the LCD will ask you if you want to cancel the broadcast job. Press **1** to clear the whole broadcast job or **2** to exit.

#### 4 Press **Stop/Exit**.

## Real Time Transmission

When you are sending a fax, the machine will scan the documents into the memory before sending it. Then, as soon as the telephone line is free, the machine will start dialling and sending.

Sometimes, you may want to send an important document immediately, without waiting for memory transmission. You can set `Real Time TX` to `On` for all documents or `Next Fax:On` for the next fax only.



### Note

- If the memory is full, the machine will send the document in real time (even if `Real Time TX` is set to `Off`).
- `Next Fax:On` or `Next Fax:Off` can be selected only if a document is loaded.

### Sending in real time for all faxes

- 1 Make sure you are in FAX mode .
- 2 Press **Menu, 2, 2, 5**.
- 3 Press **▲** or **▼** to choose `On`. Press **OK**.

### Sending in real time for the next fax only

- 1 Make sure you are in FAX mode .
- 2 Press **Menu, 2, 2, 5**.
- 3 Press **▲** or **▼** to choose `Next Fax:On`. Press **OK**.

### Not sending in real time for the next fax only

- 1 Make sure you are in FAX mode .
- 2 Press **Menu, 2, 2, 5**.

- Press ▲ or ▼ to choose **Next Fax:Off**. Press **OK**.

## Overseas Mode

If you are having difficulty sending a fax overseas due to a bad connection, then turning on Overseas Mode may help.

This is a temporary setting, and will only be active for your next fax.

- Make sure you are in FAX mode .
- Load your document.
- Press **Menu, 2, 2, 9**.
- Press ▲ or ▼ to choose **On or Off**. Press **OK**.

## Delayed Fax

You can store up to 50 faxes in the memory to be sent within a twenty four hour period.

- Make sure you are in FAX mode .
- Load your document.
- Press **Menu, 2, 2, 3**.
- Enter the time you want the fax to be sent (in 24-hour format). Press **OK**.
- Press **1** to choose **1.Doc** to leave the paper document waiting in the ADF or press **2** to choose **2.Memory** to scan the document into the memory.



### Note

The number of pages you can scan into the memory depends on the amount of data printed on each page.

## Delayed batch transmission

Before sending the delayed faxes, your machine will help you economize by sorting all the faxes in the memory by destination and scheduled time.

All delayed faxes that are scheduled to be sent at the same time to the same fax number will be sent as one fax to save transmission time.

- Make sure you are in FAX mode .
- Press **Menu, 2, 2, 4**.
- Press ▲ or ▼ to choose **On or Off**. Press **OK**.
- Press **Stop/Exit**.

## Checking and cancelling waiting jobs

Check which jobs are still waiting in the memory to be sent. If there are no jobs, the LCD will show **No Jobs Waiting**. You can cancel a fax job that is stored and waiting in the memory.

- Press **Menu, 2, 7**.  
The number of jobs still to be sent will be displayed.
- Press ▲ or ▼ to scroll through the waiting jobs and press the job you want to cancel. Press **OK**.
- Do one of the following:
  - To cancel the job, press **1**.
  - To exit without cancelling, press **2**.
- When you have finished, press **Stop/Exit**.

## Electronic cover page

This feature will *not* work unless you have already programmed your Station ID. (See Quick Setup Guide.)

You can automatically send a cover page with every fax. Your cover page includes your Station ID, a comment, and the name stored in the One Touch or Speed Dial memory.

By choosing `Next Fax:On` you can also display the number of pages on the cover page.

You can choose one of the following preset comments.

1. Note Off
2. Please Call
3. Urgent
4. Confidential

Instead of using one of the preset comments, you can enter two personal messages of your own, up to 27 characters long. See Basic User's Guide: *Entering text*.

(See *Composing your own comments* >> page 16.)

5. (User Defined)
6. (User Defined)



### Note

`Next Fax:On` or `Next Fax:Off` can be selected only if a document is loaded.

## Composing your own comments

You can set up two comments of your own.

- 1 Make sure you are in FAX mode .
- 2 Press **Menu, 2, 2, 8**.
- 3 Press **▲** or **▼** to choose 5. or 6. to store your own comment.  
Press **OK**.
- 4 Enter your own comment using the dial pad. See Basic User's Guide: *Entering text*.  
Press **OK**.

## Send a cover page for the next fax

If you want to send a cover page only for the next fax, your machine will ask you to enter the number of pages you are sending so it can be printed on the cover page.

- 1 Make sure you are in FAX mode .
- 2 Load your document.
- 3 Press **Menu, 2, 2, 7**.
- 4 Press **▲** or **▼** to choose `Next Fax:On` (or `Next Fax:Off`).  
Press **OK**.
- 5 Press **▲** or **▼** to choose a comment.  
Press **OK**.
- 6 Enter two digits to show the number of pages you are sending.  
Press **OK**.  
For example, enter **0, 2** for 2 pages or **0, 0** to leave the number of pages blank. If you make a mistake, press **◀** or **Clear** to back up and re-enter the number of pages.

## Send a cover page for all faxes

You can set the machine to send a cover page whenever you send a fax.

- 1 Make sure you are in FAX mode .
- 2 Press **Menu**, **2**, **2**, **7**.
- 3 Press **▲** or **▼** to choose **On** (or **Off**).  
Press **OK**.
- 4 Press **▲** or **▼** to choose a comment.  
Press **OK**.

## Using a printed cover page

If you want to use a printed cover page that you can write on, you can print the sample page and attach it to your fax.

- 1 Make sure you are in FAX mode .
- 2 Press **Menu**, **2**, **2**, **7**.
- 3 Press **▲** or **▼** to choose **Print Sample**.  
Press **OK**.
- 4 Press **Start**.
- 5 After the machine prints a copy of your cover page, press **Stop/Exit**.

## Polling overview

Polling lets you set up your machine so other people can receive faxes from you, but they pay for the call. It also lets you call somebody else's fax machine and receive a fax from it, so you pay for the call. The polling feature needs to be set up on both machines for this to work. Not all fax machines support polling.

### Polled transmit

Polled transmit lets you set up your machine to wait with a document so another fax machine can call and retrieve it.

#### Setup for polled transmit

- 1 Make sure you are in FAX mode .
- 2 Load your document.
- 3 Press **Menu, 2, 2, 6**.
- 4 Press **▲** or **▼** to choose `Standard`. Press **OK**.
- 5 Press **1** to choose `1.Doc` to leave the paper document waiting in the ADF or press **2** to choose `2.Memory` to scan the document into the memory.



#### Note

- If you choose `Doc`, the document remains in the ADF until your machine is polled. If you must use your machine before the polled transmission occurs, you must first cancel this job.
- If you choose `Memory`, the document will be stored and can be retrieved from any other fax machine until you delete the fax in memory by using the `Cancelling a Job` menu setting.

To delete the fax from memory, press **Menu, 2, 7**. (See *Checking and cancelling waiting jobs* >> page 15.)

- 6 Press **2** to choose `2.No` if you do not want to enter more settings when the LCD asks you the following message:

```
Next
1.Yes 2.No
```

- 7 Press **Start**.

#### Setup for polled transmit with a secure code

Secure polling lets you restrict who can get the documents you set up to be polled. Secure polling only works with Brother fax machines. If another person wants to retrieve a fax from your machine they will have to enter the secure code.

- 1 Make sure you are in FAX mode .
- 2 Load your document.
- 3 Press **Menu, 2, 2, 6**.
- 4 Press **▲** or **▼** to choose `Secure`. Press **OK**.
- 5 Enter a four-digit number. Press **OK**.
- 6 Press **1** to choose `1.Doc` to leave the paper document waiting in the ADF or press **2** to choose `2.Memory` to scan the document into the memory.
- 7 Press **2** to choose `2.No` if you do not want to enter more settings when the LCD asks you the following message:

```
Next
1.Yes 2.No
```

- 8 Press **Start**.



## Remote Fax Options

Remote Fax Options let you receive faxes while you are away from the machine.

You can use *only one* Remote Fax Option at a time.

### Fax Forwarding

The Fax Forwarding feature lets you automatically forward your received faxes to another machine. If you choose Backup Print On, the machine will also print the fax.

- 1 Press **Menu**, **2**, **5**, **1**.
- 2 Press **▲** or **▼** to choose **Fax Forward**. Press **OK**.  
The LCD will ask you to enter the fax number you want your faxes to be forwarded to.
- 3 Enter the forwarding number (up to 20 digits). Press **OK**.



#### Note

If you store a Group on a One Touch key or a Speed Dial location, the faxes will be forwarded to multiple fax numbers.

- 4 Press **▲** or **▼** to choose **On** or **Off**. Press **OK**.

```
Backup Print
On
```

- 5 Press **Stop/Exit**.

### Important

If you choose Backup Print On, the machine will also print the fax at your machine so you will have a copy. This is a safety feature in case there is a power failure before the fax is forwarded or a problem at the receiving machine. (FAX-2840 and MFC-7240)

The faxes stored in the machine's memory will be deleted.

### Fax Storage

The Fax Storage feature lets you store your received faxes in the machine's memory. You can retrieve stored fax messages from a fax machine at another location using the remote retrieval codes. (See *Retrieving fax messages* >> page 21.) Your machine will automatically print a copy of the stored fax.

- 1 Press **Menu**, **2**, **5**, **1**.
- 2 Press **▲** or **▼** to choose **Fax Storage**. Press **OK**.
- 3 Press **Stop/Exit**.

### Changing Remote Fax Options

If received faxes are left in your machine's memory when you change to another Remote Fax Option, the LCD will ask you the following message:

```
Erase All Doc?
1.Yes 2.No
```

or

```
Print All Fax?
1.Yes 2.No
```

- If you press **1**, faxes in the memory will be erased or printed before the setting changes. If a backup copy has already been printed it will not be printed again.
- If you press **2**, faxes in the memory will not be erased or printed and the setting will be unchanged.

(For FAX-2950, MFC-7240 and MFC-7290)

If received faxes are left in the machine's memory when you change to PC Fax Receive from another remote fax option (Fax Forward or Fax Storage), the LCD will ask you the following message:

```
Send Fax to PC?
1.Yes 2.No
```

- If you press **1**, faxes in the memory will be sent to your PC before the setting changes. Faxes in the memory will be sent to your PC when the PC-Fax Receive icon is active on your PC. (See Software User's Guide.)
- If you press **2**, faxes in the memory will not be erased or transferred to your PC and the setting will be unchanged.

The LCD will ask you the following message:

```
Backup Print
On
```

Press **▲** or **▼** to choose **On** or **Off**.

Press **OK**.

Press **Stop/Exit**.

### ! Important

If you choose Backup Print On, the machine will also print the fax at your machine so you will have a copy. This is a safety feature in case if there is a power failure before the fax is forwarded or a problem at the receiving machine.

(FAX-2840 and MFC-7240)

The faxes stored in the machine's memory will be deleted.

## Turning off Remote Fax Options

- 1 Press **Menu, 2, 5, 1**.
- 2 Press **▲** or **▼** to choose **Off**. Press **OK**.



### Note

The LCD will give you options if there are received faxes still in your machine's memory. (See *Changing Remote Fax Options* >> page 19.)

- 3 Press **Stop/Exit**.

## Remote retrieval

The remote retrieval feature lets you retrieve your stored fax messages when you are not at the machine. You can call your machine from any touch tone phone or fax machine, then use the Remote Access Code to retrieve your messages.

### Setting a Remote Access Code

The Remote Access Code feature lets you access the remote retrieval features when you are away from your machine. Before you use the remote access and retrieval features, you have to set up your own code. The default code is an inactive code: -- --\*.

- 1 Press **Menu, 2, 5, 2**.

```
Remote Fax Opt
2.Remote Access
```

- 2 Enter a three-digit code using the numbers **0 – 9, \* or #**. Press **OK**.

- 3 Press **Stop/Exit**.

**Note**

DO NOT use the same code used for your Remote Activation code (\*51) (\*91 for New Zealand) or Remote Deactivation code (#51) (#91 for New Zealand). (See Basic User's Guide: *Using Remote Codes*.)

You can change your code at any time. If you want to make your code inactive, press **Clear** and **OK** in 2 to restore the default setting --\*.

**Using your Remote Access Code**

- 1 Dial your fax number from a telephone or another fax machine using touch tone.
- 2 When your machine answers, during a period of silence enter your Remote Access Code.
- 3 The machine signals if it has received messages:
  - *No beeps*  
No messages received.
  - *1 long beep*  
Fax messages received.
- 4 The machine gives two short beeps to tell you to enter a command. The machine will hang up if you wait longer than 30 seconds before entering a command. If you enter an invalid command the machine will beep three times.
- 5 Press **9 0** to reset the machine when you have finished.
- 6 Hang up.

**Note**

If your machine is set to **Manual** mode, you can still access the remote retrieval features. Dial the fax number as normal and let the machine ring. After 100 seconds you will hear a long beep to tell you to enter the remote access code. You will then have 30 seconds to enter the code. This function may not be available in some countries e.g. Australia.

4

**Retrieving fax messages**

- 1 Dial your fax number from a telephone or another fax machine using touch tone.
- 2 When your machine answers, during a period of silence enter your Remote Access Code (3 digits followed by \*). If you hear one long beep, you have messages.
- 3 When you hear two short beeps, use the dial pad to press **9 6 2**.
- 4 Wait for a long beep, and then use the dial pad to enter the number of the remote fax machine where you want your fax messages sent, followed by **##** (up to 20 digits).
- 5 Hang up after you hear your machine beep. Your machine will call the other machine, which will then print your fax messages.

**Note**

You can insert a pause in a fax number by using the # key.

## Changing the Fax Forwarding number

You can change the default setting of your fax forwarding number from another telephone or fax machine using touch tone.

- 1 Dial your fax number from a telephone or another fax machine using touch tone.
- 2 When your machine answers, enter your Remote Access Code (3 digits followed by \*) during a period of silence. If you hear one long beep, you have messages.
- 3 When you hear two short beeps, use the dial pad to press **9 5 4**.
- 4 Wait for a long beep, and then use the dial pad to enter the new number of the remote fax machine where you want your fax messages forwarded followed by **##** (up to 20 digits).
- 5 Press **9 0** to reset the machine when you have finished.
- 6 Hang up after you hear your machine beep.



### Note

---

You can insert a pause in a fax number by using the # key.

---

## Remote fax commands

Follow the commands below to access features when you are away from the machine. When you call the machine and enter your Remote Access Code (3 digits followed by \*), the system will give two short beeps and you must enter a remote command.

Remote commands		Operation details
95	<b>Change the fax forwarding or fax storage settings</b>	
	1 OFF	You can choose <code>OFF</code> after you have retrieved or erased all your messages.
	2 Fax Forwarding	One long beep means the change is accepted. If you hear three short beeps, you cannot make the change because the conditions have not been met (for example, registering a fax forwarding number). You can register your fax forwarding number by entering 4. (See <i>Changing the Fax Forwarding number</i> >> page 22.) Once you have registered the number, fax forwarding will work.
	4 Fax Forwarding number	
6 Fax Storage		
96	<b>Retrieve a fax</b>	
	2 Retrieve all faxes	Enter the number of a remote fax machine to receive stored fax messages. (See <i>Retrieving fax messages</i> >> page 21.)
	3 Erase faxes from the memory	If you hear one long beep, fax messages have been erased from the memory.
97	<b>Check the receiving status</b>	
	1 Fax	You can check whether your machine has received any faxes. If yes, you will hear one long beep. If no, you will hear three short beeps.
98	<b>Change the Receive Mode</b>	
	1 External TAD	If you hear one long beep, your change has been accepted.
	2 Fax/Tel	
	3 Fax Only	
90	<b>Exit</b>	Press <b>9 0</b> to exit remote retrieval. Wait for the long beep, then replace the handset.

## Additional receiving operations

### Printing a reduced incoming fax

If you choose **On**, the machine automatically reduces each page of an incoming fax to fit on one page of A4, Letter, Legal<sup>1</sup> or Folio<sup>1</sup> size paper.

<sup>1</sup> For Asia

The machine calculates the reduction ratio by using the page size of the fax and your Paper Size setting (**Menu, 1, 2, 2**).

- 1 Make sure you are in FAX mode .
- 2 Press **Menu, 2, 1, 5**.
- 3 Press **▲** or **▼** to choose **On** or **Off**. Press **OK**.
- 4 Press **Stop/Exit**.

### Setting the Fax Receive Stamp

You can set the machine to print the received date and time at the top of each received fax page.

- 1 Make sure you are in FAX mode .
- 2 For FAX-2840 and MFC-7240, press **Menu, 2, 1, 9**.  
For FAX-2950 and MFC-7290, press **Menu, 2, 1, 8**.
- 3 Press **▲** or **▼** to choose **On** or **Off**. Press **OK**.

- 4 Press **Stop/Exit**.



#### Note

Make sure you have set the current date and time in the machine. (See Quick Setup Guide.)

### Receiving faxes into memory (FAX-2840 and MFC-7240)

When the paper tray becomes empty while receiving a fax, the screen will display **No Paper**. Load some fresh paper in to the paper tray. (See Basic User's Guide: *Loading paper and print media*.) If you do not load paper in the tray, the machine will perform one of the following actions:

#### If Memory Receive is On:

The machine will carry on receiving the current fax, with the remaining pages being stored in memory, if enough memory is available. Further incoming faxes will not be stored in memory. Further incoming faxes will also be stored into memory until the memory is full. When the memory is full the machine will stop automatically answering calls. To print the faxes, put fresh paper in the tray and press **Start**.

#### If Memory Receive is Off:

The machine will carry on receiving the current fax, with the remaining pages being stored in memory, if enough memory is available. Further incoming faxes will not be stored in memory. The machine will then stop automatically answering calls until fresh paper is put in the paper tray. To print the last fax you received, put fresh paper in the tray and press **Start**.

- 1 Make sure you are in FAX mode .
- 2 Press **Menu, 2, 1, 6**.
- 3 Use **▲** or **▼** to choose **On** or **Off**. Press **OK**.

- 4 Press **Stop/Exit**.

## Setting the Print Density

You can adjust the Print Density setting to make your printed pages darker or lighter.

- 1 Make sure you are in FAX mode .
- 2 For FAX-2840 and MFC-7240, press **Menu, 2, 1, 7**.  
For FAX-2950 and MFC-7290, press **Menu, 2, 1, 6**.
- 3 Press **▶** to make the print darker.  
Or, press **◀** to make the print lighter.  
Press **OK**.
- 4 Press **Stop/Exit**.

## Printing a fax from the memory

If you are using the Fax Storage feature (**Menu, 2, 5, 1**), you can still print a fax from the memory when you are at your machine. (See *Fax Storage* >> page 19.)

- 1 Press **Menu, 2, 5, 3**.
- 2 Press **Start**.
- 3 Press **Stop/Exit**.

## Out of Paper Reception

As soon as the paper tray becomes empty during fax reception, the LCD shows **No Paper**. Put some paper in the paper tray. (See *Basic User's Guide: Loading paper and print media*.)

The machine will carry on receiving the fax, with the remaining pages being stored in memory, if enough memory is available.

Incoming faxes will continue to be stored in the memory until the memory becomes full or paper is loaded in the paper tray. When the memory is full the machine will stop automatically answering calls. To print the faxes, put fresh paper in the tray and press **Start**.

(For FAX-2840 and MFC-7240)  
For details on how to set the Memory Receive manually, see *Receiving faxes into memory (FAX-2840 and MFC-7240)* >> page 24.

## Polling overview

Polling lets you set up your machine so other people can receive faxes from you, but they pay for the call. It also lets you call somebody else's fax machine and receive a fax from it, so you pay for the call. The polling feature needs to be set up on both machines for this to work. Not all fax machines support polling.

### Polling receive

Polling receive lets you call another fax machine to receive a fax.

- 1 Make sure you are in FAX mode .
- 2 For FAX-2840 and MFC-7240, press **Menu, 2, 1, 8**.  
For FAX-2950 and MFC-7290, press **Menu, 2, 1, 7**.
- 3 Press **▲** or **▼** to choose *Standard*. Press **OK**.
- 4 Enter the fax number you are polling. Press **Start**.

### Secure polling

Secure polling lets you restrict who can get the documents you set up to be polled. Secure polling only works with Brother fax machines. If you want to get a fax from a secured Brother machine you have to enter the secure code.

- 1 Make sure you are in FAX mode .
- 2 For FAX-2840 and MFC-7240, press **Menu, 2, 1, 8**.  
For FAX-2950 and MFC-7290, press **Menu, 2, 1, 7**.
- 3 Press **▲** or **▼** to choose *Secure*. Press **OK**.
- 4 Enter a four-digit secure code. Press **OK**.

This is the security code of the fax machine you are polling.

- 5 Enter the fax number you are polling.
- 6 Press **Start**.

### Delayed polling

Delayed polling lets you set the machine to begin polling receive at a later time. You can only set up *one* delayed polling operation.

- 1 Make sure you are in FAX mode .
- 2 For FAX-2840 and MFC-7240, press **Menu, 2, 1, 8**.  
For FAX-2950 and MFC-7290, press **Menu, 2, 1, 7**.
- 3 Press **▲** or **▼** to choose *Timer*. Press **OK**.
- 4 Enter the time (in 24-hour format) you want to begin polling. Press **OK**.
- 5 Enter the fax number you are polling. Press **Start**.  
The machine makes the polling call at the time you entered.



#### Note

If the other fax machine that you are calling has not been set-up for Polling, you will receive the message *Connection Fail*.

### Sequential polling

Sequential polling lets you request documents from several fax machines in one operation.

- 1 Make sure you are in FAX mode .
- 2 For FAX-2840 and MFC-7240, press **Menu, 2, 1, 8**.  
For FAX-2950 and MFC-7290, press **Menu, 2, 1, 7**.



- 3 Press ▲ or ▼ to choose **Standard**, **Secure** or **Timer**. Press **OK**.
- 4 Choose one of the options below.
  - If you choose **Standard** go to step 5.
  - If you choose **Secure**, enter a four-digit number, press **OK**, go to step 5.
  - If you chose **Timer**, enter the time (in 24-hours format) you want to begin polling and press **OK**, go to step 5.

**Note**

If you did not enter the correct **Secure Code**, you will receive the message **Disconnected**.

- 5 Specify the destination fax machines you want to poll by using **One Touch**, **Speed Dial**, **Search**, a **Group** or the dial pad. You must press **OK** between each location.
- 6 Press **Start**.

## Stop polling

To cancel the polling process, press **Stop/Exit** while the machine is dialling, and then press **1**.

To cancel all sequential polling receive jobs, press **Menu**, **2**, **7**. (See *Checking and cancelling waiting jobs* >> page 15.)

## Telephone line services

### Caller ID

The Caller ID feature lets you use the Caller ID subscriber service offered by many local telephone companies. Call your telephone company for details. This service shows the telephone number, or name if it is available, of your caller as the line rings.

After a few rings, the LCD will show the telephone number of your caller (and name, if available). Once you answer a call, the Caller ID information disappears from the LCD, but the call information stays stored in the Caller ID memory.

- You will see the number (or name) on the LCD.
- The `ID Unknown` message means the call originated outside your Caller ID service area.
- The `ID Withheld` message means the caller has intentionally blocked transmission of information.

You can print a list of the Caller ID information received by your machine. (See *Printing the Caller ID List* >> page 28.)



#### Note

- The Caller ID service varies with different carriers. Call your local telephone company to find out about the kind of service available in your area.
- This feature may not be available in some countries.

### Viewing the Caller ID List

Your machine stores information for the last thirty calls in the Caller ID list. You can view or print this list. When the 31st call comes in to the machine, it replaces information about the first call.

- 1 Press **Menu, 2, 0, 3**.  
The screen displays the current setting.
- 2 Press **▲** or **▼** to choose `Display #`. Press **OK**.  
The Caller ID of the last call will appear on the display.  
If no ID is stored, the beeper will sound and `No Caller ID` will appear on the display, go to step 4.
- 3 Press **▲** or **▼** to scroll through the Caller ID memory to choose the Caller ID you want to view, and then press **OK**.  
The LCD will show the caller's number and the date and time of the call.
- 4 To finish viewing, press **Stop/Exit**.

### Printing the Caller ID List

- 1 Press **Menu, 2, 0, 3**.
- 2 Press **▲** or **▼** to choose `Print Report`. Press **OK**.  
If no ID is stored, the beeper will sound and `No Caller ID` will appear on the LCD, go to step 4.
- 3 Press **Start**.
- 4 After printing has finished, press **Stop/Exit**.

## Additional dialling operations

### Combining quick dial numbers

You can combine more than one Quick Dial number when you dial. This feature may be useful if you need to dial an access code for a cheaper rate from another long distance carrier.

For example, you might have stored '01632' on Speed Dial #003 and '960555' on Speed Dial #002. You can use them both to dial '01632-960555' if you press the following keys:

Press  ▲ (Address Book) 003.

Press  ▲ (Address Book) 002 and **Start**.

Numbers can be added manually by entering them on the dial pad:

Press  ▲ (Address Book) 003, 960556 (on the dial pad), and **Start**.

This would dial '01632-960556'. You can also add a pause by pressing **Redial/Pause** key.

## Additional ways to store numbers

### Setting up Groups for Broadcasting

If you often want to send the same fax message to many fax numbers you can set up a Group.

Groups are stored on to a One Touch key or a Speed Dial number. Each Group uses up a One Touch key or a Speed Dial location. You can then send the fax message to all the numbers stored in a Group just by pressing a One Touch key or entering a Speed Dial number, and then pressing **Start**.

Before you can add numbers to a Group, you need to store them as One Touch or Speed Dial numbers. You can have up to 8 small Groups, or you can assign up to 221 numbers to one large Group.

- 1 Press **Menu**, 2, 3, 3.

Address Book  
 3. Setup Groups

- 2 Choose the One Touch key or Speed Dial location where you want to store the Group.

- Press a One Touch key.

- Press  ▲ (Address Book) and then enter the three-digit Speed Dial location.

Press **OK**.



#### Note

Please select a One Touch key or a Speed Dial number that has not been used to store a number.

- 3 Use the dial pad to enter a Group number (1 to 8). Press **OK**.

- 4 To add One Touch or Speed Dial numbers follow the instructions below:

- For One Touch numbers, press the One Touch keys one after the other.
- For Speed Dial numbers, press  ▲ (**Address Book**) and then enter the three-digit Speed Dial location.

The LCD will display your chosen One Touch numbers with a \* and Speed Dial numbers with a # (for example \*006, #009).

- 5 Press **OK** when you have finished adding numbers.

- 6 Do one of the following:

- Enter the name using the dial pad (up to 15 characters). See Basic User's Guide: *Entering text*.  
Press **OK**.
- Press **OK** to store the Group without a name.

- 7 Do one of the following:

- To store another Group for broadcasting, go to step 2.
- To finish storing Groups for broadcasting, press **Stop/Exit**.

### Note

You can easily print a list of all your Speed-Dial numbers. Numbers that are part of a group will be marked in the Group column. (See *Reports* >> page 33.)

## Changing Group numbers

If you try to change a Group number, the LCD will show the Group name or numbers already stored there.

- 1 Press **Menu, 2, 3, 3**.

```
Address Book
3.Setup Groups
```

- 2 Choose the One Touch key or Speed Dial number where the Group number is stored.

Do one of the following:

- Press the One Touch key.
- Press  ▲ (**Address Book**) and then enter the three-digit Speed Dial number.  
Press **OK**.

### Note

If the Group number you are trying to change has been set to a fax forwarding number, the LCD will ask you if you want to change the name or number.

- 3 Do one of the following:

- To change the stored Group information, press **1**. Go to step 4.
- To exit without making a change, press **Stop/Exit**.

```
G01:*001*002#001
1.Change 2.Clear
```

- 4 Add or delete One Touch or Speed Dial numbers by following the instructions below:

- To add One Touch numbers, press ◀ or ▶ to position the cursor just after the last number. Then press the additional One Touch key.
- To add Speed Dial numbers, press ◀ or ▶ to position the cursor just after the last number. Then press  ▲ (**Address Book**) and then enter the additional three-digit Speed Dial number.
- To delete One Touch or Speed Dial numbers, press ◀ or ▶ to position the cursor under the number you want to delete, and then press **Clear**.

Press **OK**.

- 5 Edit the name by the following instruction. When you have finished editing the name, press **OK**.

- To edit the name, press ◀ or ▶ to position the cursor under the character you want to change. Then press **Clear** to delete it, and enter the correct character using the dial pad.

When you have finished editing, press **OK**.

- To exit without deleting the Group, press **2**.

```

Erase This Data?
1.Yes 2.No
  
```

- 5 Press **Stop/Exit**.

- 6 Press **Stop/Exit**.

## Deleting Group numbers

If you try to delete a Group number, the LCD will show the stored Group name or numbers.

- 1 Press **Menu, 2, 3, 3**.

```

Address Book
3.Setup Groups
  
```

- 2 Choose the One Touch key or Speed Dial number where the Group is stored. Do one of the following:

- Press the One Touch key.
- Press  **▲ (Address Book)** and then enter the three-digit Speed Dial number.

Press **OK**.

### Note

If the One Touch or Speed Dial number you are trying to delete has been set to a fax forwarding number, the LCD will ask you if you want to change the name or number.

- 3 To delete the Group, press **2**.

```

G01:*001*002#001
1.Change 2.Clear
  
```

- 4 Do one of the following:

- To delete the Group, press **1**.

# 6

## Printing reports

### Fax reports

Some fax reports (transmission verification and fax journal) can be printed automatically or manually.

### Transmission verification report

---

You can use the Transmission Verification Report as proof that you sent a fax. (For details about how to set up the type of report you want, see Basic User's Guide: *Transmission verification Report*.)

### Fax Journal

---

You can set the machine to print a fax journal (activity report) at specific intervals (every 50 faxes, 6, 12 or 24 hours, 2 or 7 days). The default setting is *Every 50 Faxes*, this means that your machine will print the journal when the machine has stored 50 jobs.

If you set the interval to *Off*, you can still print the report by following the steps on the next page.

- 1 Press **Menu**, **2**, **4**, **2**.
- 2 Press **▲** or **▼** to choose an interval. Press **OK**.  
If you choose 7 days, you will be asked to choose a day when you want the 7 day countdown to begin.  
If you choose *Every 50 Faxes*, the LCD shows *Accepted*. Then go to step 4.
- 3 Enter the time to begin printing, in 24 hour format. Press **OK**.
- 4 Press **Stop/Exit**.

If you choose 6, 12, 24 hours, 2 or 7 days, the machine will print the report at the selected time and then erase all jobs from its memory. If the machine's memory becomes full with 200 jobs before the time you chose has passed, the machine will print the journal early and then erase all jobs from memory.

If you want an extra report before it is due to print, you can print it manually without erasing the jobs from memory.

# Reports

The following reports are available:

- 1 **XMIT Verify**  
Displays the Transmission Verification Report for your last outgoing 200 faxes and prints the last report.
- 2 **Tel Index List**  
Prints a list of names and numbers stored in the One Touch and Speed Dial memory in numerical or alphabetical order.
- 3 **Fax Journal**  
Prints a list of information about your last 200 incoming and outgoing faxes. (TX: transmit.) (RX: receive.)
- 4 **User Settings**  
Prints a list of your current settings.

## How to print a report

---

- 1 Press **Menu**, **4**.
- 2 Do one of the following:
  - Press **▲** or **▼** to choose the report you want.  
Press **OK**.
  - Enter the number of the report you want to print. For example, press **2** to print the Tel Index List.
- 3 Press **Start**.
- 4 Press **Stop/Exit**.

# 7

## Making copies

### Copy settings

If you want to temporarily change the copy settings for the next copy, use the **Options** key. You can use different combinations.



The machine returns to its default settings one minute after copying, unless you have set the Mode Timer to 30 seconds or less. (See *Mode Timer* >> page 5.)

To change a setting, press the temporary **Options** key.

When you are finished choosing settings, press **Start**.

### Stop copying

---

To stop copying, press **Stop/Exit**.



## Using the Options key

Make sure you are in COPY mode. Use the **Options** key to quickly set the following copy settings temporarily for the next copy.

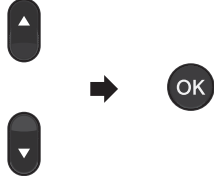
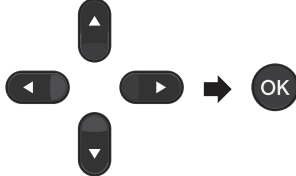
Press	Menu selections	Options	Page
<p>Options</p> 	<p>Press ▲ or ▼, then press OK</p> 	<p>Press ▲, ▼, ◀ or ▶, then press OK</p> 	
	<p>Quality</p>	<p><b>Auto*</b> Text Photo Graph</p>	37
	<p>Stack/Sort</p>	<p><b>Stack*</b> Sort</p>	37
	<p>Brightness</p>	<p>-■□□□+ -□■□□+ -□□■□+* -□□□■+ -□□□■+</p>	38
	<p>Contrast</p>	<p>-■□□□+ -□■□□+ -□□■□+* -□□□■+ -□□□■+</p>	37

	Enlarge/Reduce	<b>100%*</b> 97% LTR→A4 94% A4→LTR 91% Full Page 85% LTR→EXE 83% LGL→A4 (for Asia) 78% LGL→LTR (for Asia) 70% A4→A5 50% Custom (25-400%) Auto 200% 141% A5→A4 104% EXE→LTR	38
	Page Layout	<b>Off(1 in 1)*</b> 2 in 1 (P) 2 in 1 (L) 4 in 1 (P) 4 in 1 (L)	39
The factory settings are shown in Bold with an asterisk.			

## Improving copy quality

You can choose from a range of quality settings. The default setting is *Auto*.

### ■ Auto

Auto is the recommended mode for ordinary printouts. Suitable for documents that contain both text and photographs.

### ■ Text

Suitable for documents containing mainly text.

### ■ Photo

Better copy quality for photographs.

### ■ Graph

Suitable for copying receipts.

**To temporarily change the quality setting, follow the steps below:**

- 1 Make sure you are in COPY mode  

- 2 Load your document.
- 3 Use the dial pad to enter the number of copies (up to 99).
- 4 Press **Options**.  
Press ▲ or ▼ to choose *Quality*.  
Press **OK**.
- 5 Press ▲ or ▼ to choose *Auto*, *Text*, *Photo* or *Graph*.  
Press **OK**.
- 6 Press **Start**.

**To change the default setting, follow the steps below:**

- 1 Press **Menu**, **3**, **1**.
- 2 Press ▲ or ▼ to choose the copy quality.  
Press **OK**.
- 3 Press **Stop/Exit**.

## Sorting copies using the ADF

You can sort multiple copies. Pages will be stacked in the order 1 2 3, 1 2 3, 1 2 3, and so on.

- 1 Make sure you are in COPY mode  

- 2 Load your document in the ADF.
- 3 Use the dial pad to enter the number of copies (up to 99).
- 4 Press **Options**.  
Press ▲ or ▼ to choose *Stack/Sort*.  
Press **OK**.
- 5 Press ▲ or ▼ to choose *Sort*.  
Press **OK**.
- 6 Press **Start**.

## Adjusting Contrast and Brightness

### Contrast

Adjust the contrast to help an image look sharper and more vivid.

**To temporarily change the contrast setting, follow the steps below:**

- 1 Make sure you are in COPY mode  

- 2 Load your document.
- 3 Use the dial pad to enter the number of copies (up to 99).
- 4 Press **Options**.  
Press ▲ or ▼ to choose *Contrast*.  
Press **OK**.
- 5 Press ◀ or ▶ to increase or decrease the contrast.  
Press **OK**.

- 6 Press **Start**.

To change the *default* setting follow the steps below:

- 1 Press **Menu, 3, 3**.
- 2 Press ◀ or ▶ to increase or decrease the contrast.  
Press **OK**.
- 3 Press **Stop/Exit**.

## Brightness

Adjust the copy brightness to make copies darker or lighter.

**To temporarily change the copy brightness setting, follow the steps below:**

- 1 Make sure you are in COPY mode  
.
- 2 Load your document.
- 3 Use the dial pad to enter the number of copies (up to 99).
- 4 Press **Options**.  
Press ▲ or ▼ to choose *Brightness*.  
Press **OK**.
- 5 Press ◀ or ▶ to make a lighter copy or a darker copy.  
Press **OK**.
- 6 Press **Start**.

**To change the *default* setting follow the steps below:**

- 1 Press **Menu, 3, 2**.
- 2 Press ◀ or ▶ to make a lighter copy or a darker copy.  
Press **OK**.
- 3 Press **Stop/Exit**.

## Enlarging or reducing the image copied

You can choose the enlargement or reduction ratios.

*Auto* sets the machine to calculate the reduction ratio that best fits the size of paper.

*Custom (25–400%)* allows you to enter a ratio from 25% to 400% in 1% increments.

To enlarge or reduce the next copy follow the instructions below:

- 1 Make sure you are in COPY mode  
.
- 2 Load your document.
- 3 Use the dial pad to enter the number of copies (up to 99).
- 4 Press **Options**.  
Press ▲ or ▼ to choose *Enlarge/Reduce*.  
Press **OK**.
- 5 Do one of the following:
  - Press ▲ or ▼ to choose the enlargement or reduction ratio you want.  
Press **OK**.
  - Press ▲ or ▼ to choose *Custom (25–400%)*.  
Press **OK**.  
Use the dial pad to enter an enlargement or reduction ratio from 25% to 400%. (For example, press **5 3** to enter 53%.)  
Press **OK**.
- 6 Press **Start**.

**Note**

Page Layout Options 2 in 1 (P), 2 in 1 (L), 4 in 1 (P) and 4 in 1 (L) are *not* available with Enlarge/Reduce.

## Making N in 1 copies (page layout)

You can reduce the amount of paper used when copying by using the N in 1 copy feature. This allows you to copy two or four pages onto one page.

### Important

- Please make sure the paper size is set to A4, Letter, Legal<sup>1</sup> or Folio<sup>1</sup>.
  - <sup>1</sup> For Asia
- (P) means Portrait and (L) means Landscape.
- You cannot use the Enlarge/Reduce setting with the N in 1 feature.

- 1 Make sure you are in COPY mode .
- 2 Load your document.
- 3 Use the dial pad to enter the number of copies (up to 99).
- 4 Press **Options**. Press **▲** or **▼** to choose `Page Layout`. Press **OK**.
- 5 Press **▲** or **▼** to choose `2 in 1 (P)`, `2 in 1 (L)`, `4 in 1 (P)`, `4 in 1 (L)` or `Off(1 in 1)`. Press **OK**.
- 6 Press **Start** to scan the page.

Insert your document *face down* in the direction shown below:

#### ■ 2 in 1 (P)



#### ■ 2 in 1 (L)



#### ■ 4 in 1 (P)



#### ■ 4 in 1 (L)



## Manual Duplex (two-sided) Copying

If you want to copy two sided documents manually, use the manual feed slot.

- 1 Make sure you are in COPY mode .
- 2 Place the first page of the document in the ADF. (See Basic User's Guide: *How to load documents*.)
- 3 Load a sheet of paper into the manual feed slot. (See Basic User's Guide: *Loading paper in the manual feed slot*.)
- 4 Press **Start** to copy the first page.
- 5 After the machine scans the first page, place the second document in the ADF.
- 6 Turn over the printed paper and load it into the manual feed slot again to copy onto the other side.

- 7 Press **Start** to copy the other side.



**Note**

Place the document in the ADF and load paper into the manual feed slot in the direction shown in the following illustration:

- If your document is flipped on the Long edge

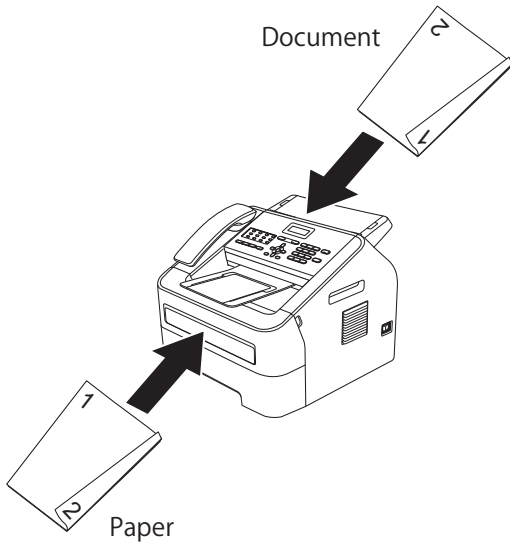

- If your document is flipped on the Short edge

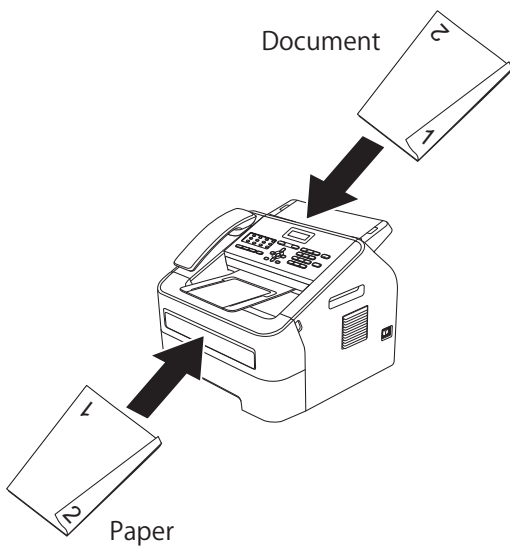

## Cleaning the machine

Clean the outside and inside of the machine regularly with a dry, lint-free cloth. When you replace the toner cartridge or the drum unit, make sure that you clean the inside of the machine. For details about cleaning the machine, see Basic User's Guide.

### **⚠ WARNING**

DO NOT use flammable substances, any type of spray, or an organic solvent/liquid containing alcohol or ammonia to clean the inside or outside of the machine. Doing so could cause a fire. Instead, use only a dry, lint-free cloth. (See Product Safety Guide: *General precautions.*)



Be careful not to inhale toner.

### **ⓘ Important**

Use neutral detergents. Cleaning with volatile liquids such as thinner or benzine will damage the surface of the machine.

## Checking the machine

### Checking the Page Counters

You can see the machine's Page Counters for copies, printed pages, reports and lists, faxes or a summary total.

- 1 Press **Menu**, **5**, **2**.
- 2 Press **▲** or **▼** to see **Total**, **Fax/List**, **Copy** or **Print**.
- 3 Press **Stop/Exit**.

### Checking the remaining life of parts

You can see the machine's parts life on the LCD.

- 1 Press **Menu**, **5**, **3**.
- 2 Press **Stop/Exit**.

# Packing and shipping the machine



## Note

- If for any reason you must ship your machine, carefully repack the machine in the original packaging to avoid any damage during transit. The machine should be adequately insured with the carrier.
- If you are returning your machine to Brother as part of the Exchange Service, pack only the machine. Keep all separate parts, including the drum unit, the toner cartridge, and printed materials to use with your 'Exchange' machine.

- 1 Turn off the machine's power switch. Disconnect all the cables, and then unplug the power cord from the AC power outlet and remove the ADF Document Output Support. Leave the machine turned off for at least 10 minutes to cool down.
- 2 Open the front cover.
- 3 Remove the drum unit and toner cartridge assembly. Leave the toner cartridge installed in the drum unit.

- 4 Put the protective material (1) in the machine with the "REMOVE" text to the left, as shown in the illustration.

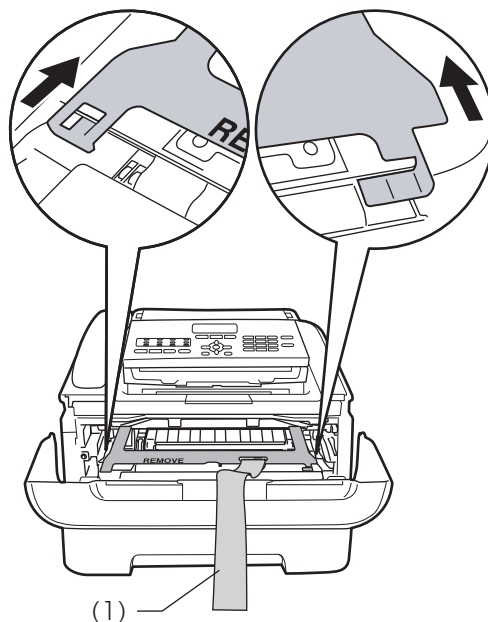

- 5 If you are not returning the machine as part of an Exchange Service, put the drum unit and toner cartridge assembly back into the machine.
- 6 Put the elastic band over the handle of the drum unit, as shown in the illustration.

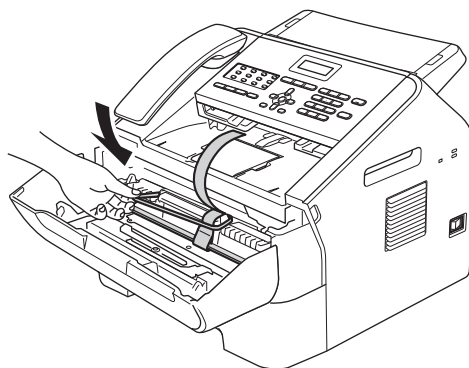



- 7 Close the front cover.  
Remove the handset and the handset's curled cord.
- 8 Put the machine into the bag it originally came in.

- 9 Pack the AC power cord and printed materials in the original carton as shown below:

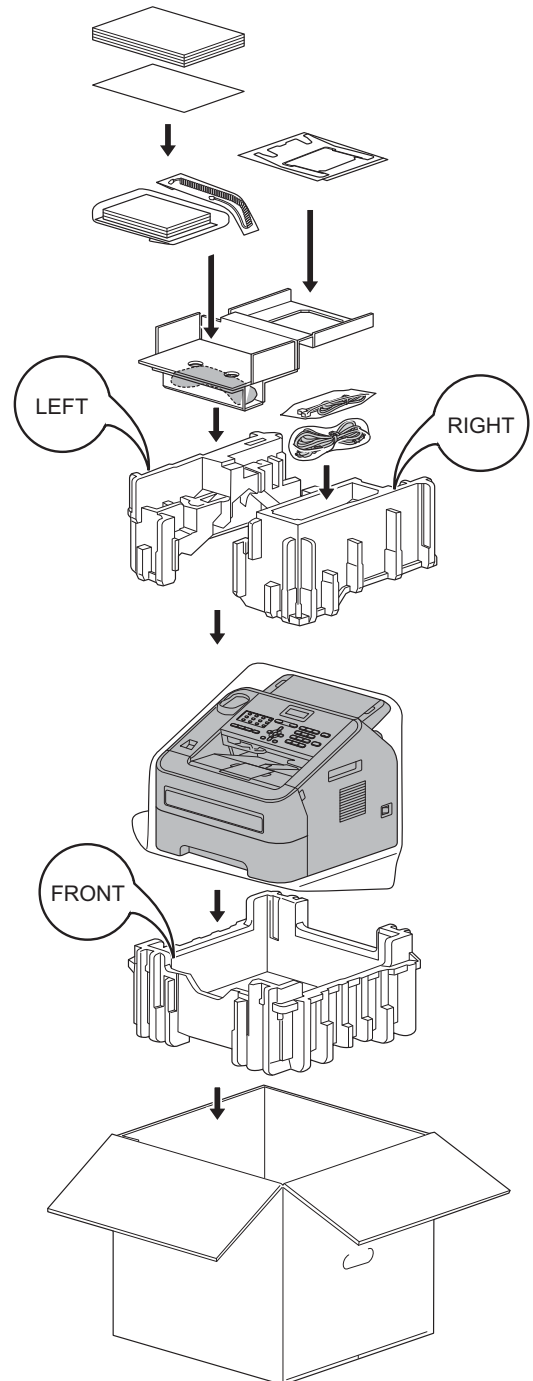

- 10 Close the carton and tape it shut.

# B

## Glossary

This is a comprehensive list of features and terms that appear in Brother manuals. Availability of these features depends on the model you purchased.

### **ADF (automatic document feeder)**

The document can be placed in the ADF and scanned one page at a time automatically.

### **Address Book** ▲

A pre-programmed number for easy

dialling. You must press  ▲ (**Address Book**), then enter the three digit Speed Dial location and press **Start** to begin the dialling process.

An electronic, alphabetical listing of stored One Touch, Speed Dial and Group numbers.

### **Auto Reduction**

Reduces the size of incoming faxes.

### **Automatic fax transmission**

Sending a fax without picking up machine's handset or pressing **Hook/Hold**.

### **Automatic Redial**

A feature that enables your machine to redial the last fax number after five minutes, if the fax did not go through because the line was busy.

### **Backup Print**

Your machine prints a copy of every fax that is received and stored in memory. This is a safety feature so you will not lose messages during a power failure.

### **Batch Transmission**

As a cost saving feature, all delayed faxes to the same fax number will be sent as one transmission.

### **Beeper Volume**

Volume setting for the beep when you press a key or make an error.

### **Broadcasting**

The ability to send the same fax message to more than one location.

### **Cancel Job**

Cancels a programmed print job and clears the machine's memory.

### **CNG tones**

The special tones (beeps) sent by fax machines during automatic transmission to tell the receiving machine that a fax machine is calling.

### **Coding method**

Method of coding the information contained in the document. All fax machines must use a minimum standard of Modified Huffman (MH). Your machine is capable of greater compression methods, Modified Read (MR), Modified Modified Read (MMR) and JBIG (not for MFC-7240), if the receiving machine has the same capability.

### **Communication error (or Comm. Error)**

An error during fax sending or receiving, usually caused by line noise or static.

### **Compatibility group**

The ability of one fax unit to communicate with another. Compatibility is assured between ITU-T Groups.

### **Contrast**

Setting to compensate for dark or light documents, by making faxes or copies of dark documents lighter and light documents darker.

### **Delayed Fax**

Sends your fax at a specified later time that day.

**Distinctive Ring**

A subscriber service purchased from the telephone company that gives you another telephone number on an existing telephone line. The Brother machine uses the new number to simulate a dedicated fax line.

**Dual Access**

Your machine can scan outgoing faxes or scheduled jobs into memory at the same time it is sending a fax or receiving or printing an incoming fax.

**ECM (Error Correction Mode)**

Detects errors during fax transmission and resends the pages of the fax that had an error.

**Extension telephone**

A telephone on the fax number that is plugged into a separate wall socket.

**External phone**

A TAD (telephone answering device) or telephone that is connected to your machine.

**F/T Ring Time**

The length of time that the Brother machine fast/double-rings (when the Receive Mode setting is Fax/Tel) to notify you to pick up a voice call that it answered.

**Fax Ability**

A subscriber service purchased from the telephone company that provides another telephone number on an existing telephone line. The Brother fax machine uses the new number to simulate a dedicated fax line.

**Fax Detect**

Enables your machine to respond to CNG tones if you interrupt a fax call by answering it.

**Fax Forwarding**

Sends a fax received into the memory to another pre-programmed fax number.

**Fax Journal**

Lists information about the last 200 incoming and outgoing faxes. TX means Transmit. RX means Receive.

**Fax Storage**

You can store faxes in the memory.

**Fax tones**

The signals sent by sending and receiving fax machines while communicating information.

**Fax/Tel**

You can receive faxes and telephone calls. Do not use this mode if you are using a telephone answering device (TAD).

**Fine resolution**

Resolution is 203 × 196 dpi. It is used for small print and graphs.

**Greyscale**

The shades of grey available for copying and faxing photographs.

**Group number**

A combination of One Touch and Speed Dial numbers that are stored to a One Touch key or in a Speed Dial location for Broadcasting.

**Journal Period**

The pre-programmed time period between automatically printed Fax Journal Reports. You can print the Fax Journal on demand without interrupting the cycle.

**LCD (liquid crystal display)**

The display screen on the machine that shows interactive messages during On-Screen Programming and shows the date and time when the machine is idle.

**Manual fax**

A manual fax is when you press **Hook/Hold** to hear the receiving fax machine answer before you press **Start** to begin transmission.

### Menu mode

Programming mode for changing your machine's settings.

### OCR (optical character recognition)

Nuance™ PaperPort™ 12SE or Presto! PageManager software application converts an image of text to text you can edit.

### One Touch

Keys on the machine's control panel where you can store numbers for easy dialling. You can store a second number on each key if you press **Shift** and then the One Touch key.

### Out of Paper Reception

Receives faxes into the machine's memory when the machine is out of paper.

### Overseas Mode

Makes temporary changes to the fax tones to accommodate noise and static on overseas telephone lines.

### Pause

Allows you to place a 3.5 second delay in the dialling sequence while you are dialling using the dial pad or while you are storing One Touch and Speed Dial numbers. Press **Redial/Pause** as many times as needed for longer pauses.

### Polling

The process of a fax machine calling another fax machine to retrieve waiting fax messages.

### Pulse

A form of rotary dialling on a telephone line.

### Real Time Transmission

When memory is full, you can send faxes in real time.

### Remaining Jobs

You can check which programmed fax jobs are waiting in the memory and cancel the jobs individually.

### Remote Access Code

Your own four-digit code (— — —\*) that allows you to call and access your machine from a remote location.

### Remote Activation code

Press this code (\*51) (\*91 for New Zealand) when you answer a fax call on an extension or external telephone.

### Remote Retrieval Access

The ability to access your machine remotely from a touch tone telephone.

### Resolution

The number of vertical and horizontal lines per inch.

### Ring Delay

The number of rings before the machine answers in Fax Only and Fax/Tel modes.

### Ring Volume

Volume setting for the machine's ring.

### Scanning

The process of sending an electronic image of a paper document into your computer.

### Speed Dial

A pre-programmed number for easy dialling. Press  **(Address Book)**, then enter the three-digit Speed Dial location and press **Start** to begin the dialling process.

### Station ID

The stored information that appears on the top of faxed pages. It includes the sender's name and fax number.

### TAD (telephone answering device)

You can connect an external TAD to your machine.

### Tel Index List

A listing of names and numbers stored in One Touch and Speed Dial memory, in numerical order.

**Temporary settings**

You can choose certain options for each fax transmission and copy without changing the default settings.

**Tone**

A form of dialling on the telephone line used for Touch Tone telephones.

**Transmission**

The process of sending faxes over the telephone lines from your machine to the receiving fax machine.

**User Settings List**

A printed report that shows the current settings of the machine.

**Xmit Report (Transmission Verification Report)**

A listing for each transmission, that shows its date, time and number.

# C

## Index

- 
- B**
- 
- Broadcasting ..... 13  
  cancelling ..... 14  
  setting up Groups for ..... 29
- C**
- 
- Cancelling  
  broadcast in process ..... 14  
  fax jobs in memory ..... 15  
  fax storage ..... 19  
  jobs awaiting redial ..... 15  
  remote fax options ..... 20
- Copy  
  contrast ..... 37  
  Duplex (two-sided) Copying ..... 39  
  enlarging or reducing ..... 38  
  keys ..... 34  
  N in 1 (page layout) ..... 39  
  Options key ..... 35  
  quality ..... 37  
  sort (ADF only) ..... 37  
  temporary settings ..... 34  
  using ADF ..... 37
- Cover page ..... 16  
  custom comments ..... 16  
  for all faxes ..... 17  
  for next fax only ..... 16  
  printed form ..... 17
- D**
- 
- Deep Sleep mode ..... 3  
Delayed batch transmission ..... 15
- Dialling  
  dial prefix ..... 5  
  Groups (broadcasting) ..... 13  
  restricting dialling ..... 10
- Drum unit  
  checking (remaining life) ..... 41
- Dual access ..... 13
- F**
- 
- Fax codes  
  changing ..... 20  
  remote access code ..... 20
- Fax forwarding  
  changing remotely ..... 22, 23  
  programming a number ..... 19
- Fax storage ..... 19  
  printing from memory ..... 25  
  turning off ..... 20  
  turning on ..... 19
- Fax, stand-alone  
  receiving  
    Continue Mode ..... 4  
    fax forwarding ..... 23  
    fax receive stamp ..... 24  
    into memory (fax storage) ..... 19  
    polling receive ..... 26  
    reducing to fit on paper ..... 24  
    retrieving from a remote site ..... 21, 23  
  sending ..... 11  
    broadcasting ..... 13  
    cancelling from memory ..... 15  
    contrast ..... 11  
    delayed batch ..... 15  
    delayed fax ..... 15  
    from memory (dual access) ..... 13  
    manual ..... 13  
    overseas ..... 15  
    polled transmit ..... 18  
    real time transmission ..... 14  
    resolution ..... 12
- G**
- 
- Groups for broadcasting ..... 29
- L**
- 
- LCD (liquid crystal display)  
  contrast ..... 4
- M**
- 
- Machine information  
  checking remaining life of parts ..... 41  
  page counts ..... 41
- Maintenance, routine ..... 41  
  checking the remaining life of parts ..... 41
- Manual

transmission .....	13
Memory	
storage .....	1
Memory Security .....	8

## N

---

N in 1 (page layout) .....	39
----------------------------	----

## P

---

Page layout (N in 1) .....	39
Polling	
polled transmit .....	18
polling receive .....	26
Power failure .....	1
Print	
fax from memory .....	25
reports .....	33

## Q

---

Quality	
copying .....	35, 37
Quick dial	
broadcasting .....	13
using Groups .....	13
Group dial	
setting up Groups for broadcasting ....	29

## R

---

Reducing	
copies .....	38
incoming faxes .....	24
Remote retrieval .....	20
access code .....	20, 21
commands .....	23
getting your faxes .....	21
Reports .....	32, 33
Fax Journal .....	32, 33
journal period .....	32
how to print .....	33
Tel Index List .....	33
Transmission Verification .....	32
User Settings .....	33
Resolution	
fax (standard, fine, superfine, photo) ....	12
setting for next fax .....	12
Resolution key .....	12

## S

---

Safety Instructions .....	i
Security	
restricting dialling .....	10
Setting lock .....	9
Setting up the password .....	7
Sleep mode .....	2
Sort .....	37

## T

---

Temporary copy settings .....	34
Toner Save .....	2
Toner Setting (Continue Mode) .....	3
TX Lock .....	7

**brother**<sup>®</sup>

These machines are approved for use in the country of purchase only. Local Brother companies or their dealers will only support machines purchased in their own countries.