

Read this Quick Setup Guide before using the printer.  
Before you can use the printer, you must set up the hardware and install the driver.

## Step 1

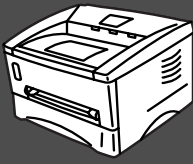

## Setting Up Your Printer

Setting Up  
Your Printer

## Step 2



## Installing the Driver

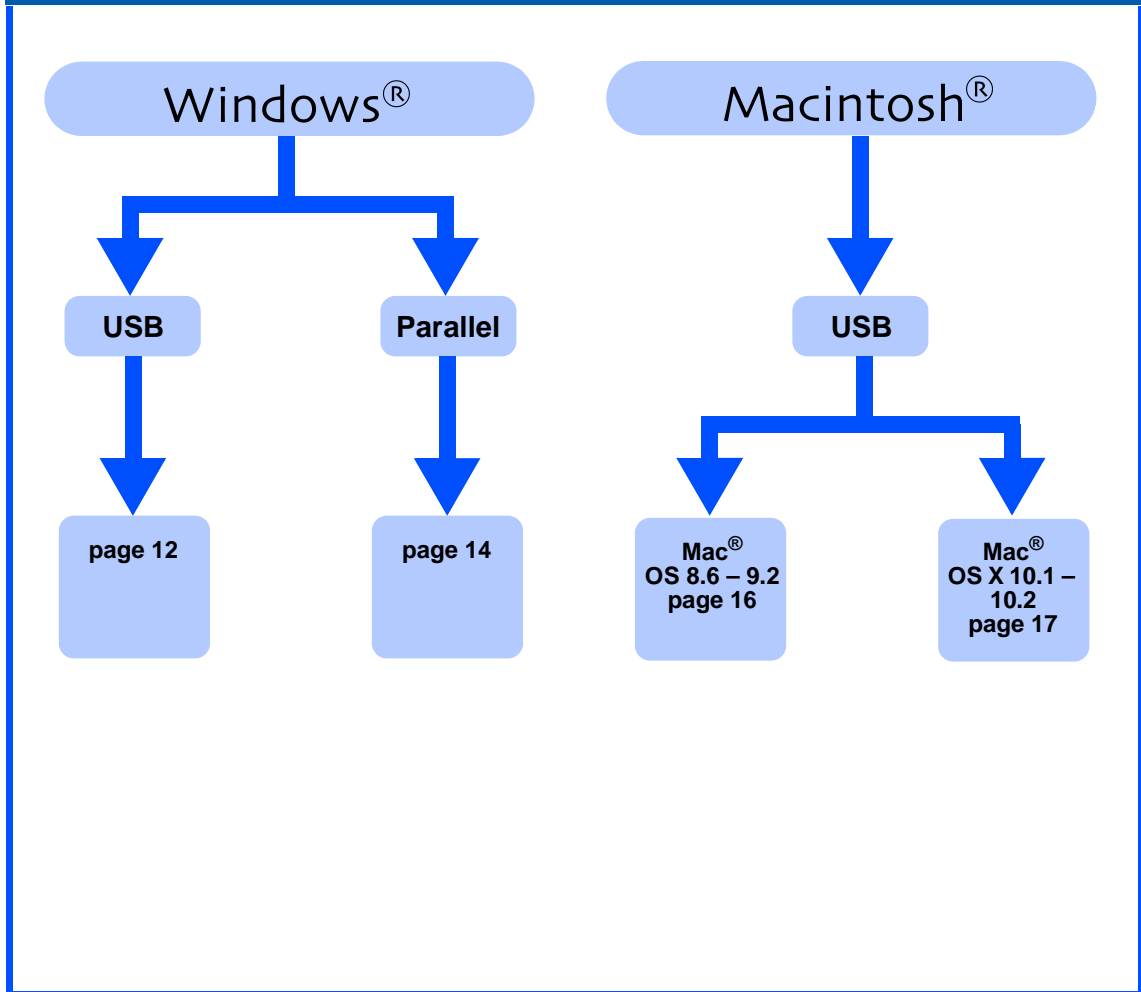

Windows®  
USB

Windows®  
Parallel

Installing the Driver

Macintosh®  
USB

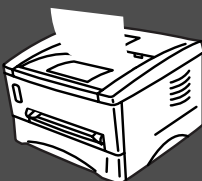





## Setup is Complete!





For the latest driver and to find the best solution for your problem or question, access the Brother Solutions Center directly from the CD-ROM/Driver or go to <http://solutions.brother.com>. Keep this Quick Setup Guide and supplied CD-ROM in a convenient place for quick and easy reference at all times.

# Safety Precautions

## To Use the Printer Safely

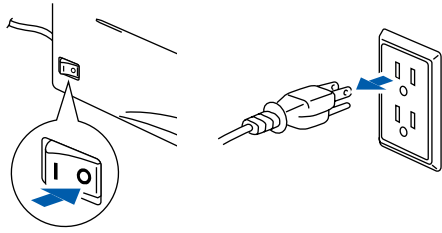
 <p><b>Warning</b></p>	 <p><b>Note</b></p>	 <p><b>Hint</b></p>	 <p><b>User's Guide</b></p>
<p>Indicates warnings that must be observed to prevent possible personal injury.</p>	<p>Indicates cautions that must be observed to use the printer properly or prevent damage to the printer.</p>	<p>Indicates notes and useful tips to remember when using the printer.</p>	<p>Indicates reference to the User's Guide that is on the CD-ROM we have supplied.</p>

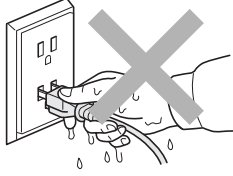
### **Warning**

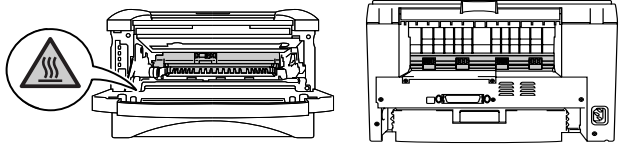
 <p>There are high voltage electrodes inside the printer. Before replacing internal parts, cleaning the printer or clearing a paper jam, make sure you have turned OFF the power switch and unplugged the power cord from the power outlet.</p>	
 <p>Do not handle the plug with wet hands. Doing this might cause an electrical shock.</p>	
 <p>After you have just used the printer, some internal parts of the printer are extremely hot. When you open the front cover or rear cover of the printer, never touch the shaded parts shown in the illustration.</p>	 <p style="text-align: center;"><b>Inside the printer (Front View)      Open the Rear cover (Rear View)</b></p>



*All models shown may not be available in your country, please check with your local Brother re-seller.*

# Table of Contents

Regulations .....	2
-------------------	---

## ■ Getting Started

---

Carton Components .....	4
Control Panel .....	5
Supplied CD-ROM .....	6



## Step 1 Setting Up Your Printer

---

1. Insert the CD-ROM into the CD-ROM Drive .....	7
2. Install the Drum Unit Assembly .....	8
3. Load Paper in the Paper Tray .....	9
4. Print a Test Page .....	10

## Step 2 Installing the Driver

---

	<b>For USB Interface Cable Users .....</b>	<b>12</b>
	1. Installing the Driver and Connecting the Printer to Your PC 2. Setting Your Printer as the Default Printer (For Windows® 2000/XP Users Only)	
	<b>For Parallel Interface Cable Users .....</b>	<b>14</b>
	Connecting the Printer to Your PC and Installing the Driver	
	<b>For USB Interface Cable Users .....</b>	<b>16</b>
	■ <b>For Mac® OS 8.6 to 9.2 Users .....</b>	<b>16</b>
	■ <b>For Mac® OS X 10.1 to 10.2 Users .....</b>	<b>17</b>

## ■ Other Information

---

Shipment of the Printer .....	19
Options .....	20

## ■ Troubleshooting



User's Guide Chapter 6

# Regulations

## Federal Communications Commission (FCC) Declaration of Conformity (For USA)

Responsible Party: Brother International Corporation  
100 Somerset Corporate Boulevard  
P.O. Box 6911  
Bridgewater, NJ 08807-0911  
USA  
Telephone: (908) 704-1700

declares, that the products

Product name: Laser Printer HL-1430, HL-1435  
Model number: HL-14

complies with Part 15 of the FCC Rules. Operation is subject to the following two conditions: (1) This device may not cause harmful interference, and (2) this device must accept any interference received, including interference that may cause undesired operation.

This equipment has been tested and found to comply with the limits for a Class B digital device, pursuant to Part 15 of the FCC Rules. These limits are designed to provide reasonable protection against harmful interference in a residential installation. This equipment generates, uses, and can radiate radio frequency energy and, if not installed and used in accordance with the instructions, may cause harmful interference to radio communications. However, there is no guarantee that interference will not occur in a particular installation. If this equipment does cause harmful interference to radio or television reception, which can be determined by turning the equipment off and on, the user is encouraged to try to correct the interference by one or more of the following measures:

- Reorient or relocate the receiving antenna.
- Increase the separation between the equipment and receiver.
- Connect the equipment into an outlet on a circuit different from that to which the receiver is connected.
- Consult the dealer or an experienced radio/TV technician for help.

### Important

A shielded interface cable should be used in order to ensure compliance with the limits for a Class B digital device. Changes or modifications not expressly approved by Brother Industries, Ltd. could void the user's authority to operate the equipment.

### Industry Canada Compliance Statement (For Canada)

This Class B digital apparatus complies with Canadian ICES-003.

Cet appareil numérique de la classe B est conforme à la norme NMB-003 du Canada.

### Radio interference (220-240 volt model only)

This printer follows EN55022 (CISPR Publication 22)/Class B.

Before you use this product, make sure that you use a double-shielded interface cable with twisted-pair conductors and that it is marked "IEEE1284 compliant". The cable must not be more than 2.0 metres long.

**brother**<sup>®</sup>

## "EC" Declaration of Conformity

### Manufacture

Brother Industries Ltd.,  
15-1, Naeshiro-cho, Mizuho-ku,  
Nagoya 467-8561, Japan

Plant  
Brother Corporation (Asia) Ltd.,  
Brother Buji Nan Ling Factory,  
Golden Garden Ind., Nan Ling Village,  
Buji Rong Gang Shenzhen, China

Herewith declare that:

Products description: Laser Printer  
Product Name: HL-1430, HL-1435  
Model Number: HL-14

is in conformity with provisions of the Directives applied: Low Voltage Directive 73/23/EEC (as amended by 93/68/EEC) and the Electromagnetic Compatibility Directive 89/336/EEC (as amended by 91/263/EEC and 92/31/EEC and 93/68/EEC).

Standards applied:

Harmonized:  
Safety: EN60950: 1992  
A1 : 1993, A2 : 1993, A3 : 1995,  
A4 : 1997, AII : 1997

EMC: EN55022: 1998 Class B  
EN61000-3-2: 1995 / A1: 1998 + A2: 1998  
EN61000-3-3: 1995  
EN55024 : 1998

Year in which CE marking was first affixed: 2003

Issued by: Brother Industries, Ltd.  
Date: 25 December, 2002  
Place: Nagoya, Japan  
Signature:

*Takashi Maeda*

Takashi Maeda  
Manager  
Quality Audit Group  
Quality Management Dept.  
Information & Document Company

### International ENERGY STAR<sup>®</sup> Compliance Statement

The purpose of the International ENERGY STAR<sup>®</sup> Program is to promote the development and popularization of energy-efficient office equipments. As an ENERGY STAR<sup>®</sup> Partner, Brother Industries, Ltd. has determined that this product meets the ENERGY STAR<sup>®</sup> guidelines for energy efficiency.



### Laser Safety (100 to 120 volt Model Only)

This printer is certified as a Class I laser product under the U.S. Department of Health and Human Services (DHHS) Radiation Performance Standard according to the Radiation Control for Health and Safety Act of 1968. This means that the printer does not produce hazardous laser radiation.

Since radiation emitted inside the printer is completely confined within protective housings and external covers, the laser beam cannot escape from the machine during any phase of user operation.

## FDA Regulations (100 to 120 volt Model Only)

U.S. Food and Drug Administration (FDA) has implemented regulations for laser products manufactured on and after August 2, 1976. Compliance is mandatory for products marketed in the United States. One of the following labels on the back of the printer indicates compliance with the FDA regulations and must be attached to laser products marketed in the United States.

MANUFACTURED:  
Brother Industries, Ltd.,  
15-1 Naeshiro-cho Mizuho-ku Nagoya, 467-8561 Japan  
This product complies with FDA radiation performance standards, 21 CFR subchapter J.

MANUFACTURED:  
Brother Corporation (Asia) Ltd. Brother Buji Nan Ling Factory  
Gold Garden Ind., Nan Ling Village, Buji, Rong Gang, Shenzhen, CHINA  
This product complies with FDA radiation performance standards, 21 CFR Subchapter J

⚠ Caution: Use of controls, adjustments or performance of procedures other than those specified in this manual may result in hazardous radiation exposure.

## IEC 60825 specification (220 to 240 volt model only)

This printer is a Class 1 laser product as defined in IEC 60825 specifications. The label shown below is attached in countries where it is needed.

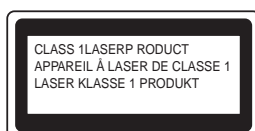

This printer has a Class 3B laser diode which produces invisible laser radiation in the scanner unit. You should not open the scanner unit under any circumstances.

⚠ Caution: Use of controls or adjustments or performance of procedures other than those specified herein may result in hazardous radiation exposure.

## For Finland and Sweden

### LUOKAN 1 LASERLAITE KLASS 1 LASER APPARAT

⚠ Varoitus! Laitteen käyttäminen muulla kuin tässä käyttöohjeessa mainitulla tavalla saattaa altistaa käyttäjän turvallisuusluokan 1 ylittävälle näkymättömälle lasersäteilylle.

⚠ Varning Om apparaten används på annat sätt än i denna Bruksanvisning specificerats, kan användaren utsättas för osynlig laserstrålning, som överskrider gränsen för laserklass 1.

## Internal laser radiation

Maximum radiation power: 5 mW

Wave length: 760 - 810 nm

Laser class: Class IIIb  
(Accordance with 21 CFR Part 1040.10)  
Class 3B  
(Accordance with IEC 60825)

## IMPORTANT - For Your Safety

To ensure safe operation the supplied three-pin plug must be inserted only into a standard three-pin power outlet that is properly grounded through the normal household wiring.

Extension cords used with this printer must be three-pin plug type and correctly wired to provide proper grounding. Incorrectly wired extension cords may cause personal injury and equipment damage.

The fact that the equipment operates satisfactorily does not imply that the power is grounded and that the installation is completely safe. For your safety, if in any doubt about the effective grounding of the power, call a qualified electrician.

## Disconnect device

You must install this printer near a power outlet that is easily accessible. In case of an emergency, you must disconnect the power cord from the power outlet to shut off the power completely.

## Caution for LAN connection

Connect this product to a LAN connection that is not subjected to over voltages.

## IT power system (For Norway only)

This product is also designed for an IT power system with phase-to-phase voltage 230V.

## Geräuschemission / Acoustic noise emission (for Germany only)

Lpa < 70 dB (A) DIN 45635-19-01-KL2

## Wiring information (for UK)

### Important

If the mains plug that is supplied with this printer is not suitable for your plug socket, remove the plug from the mains lead and fit an appropriate three-pin plug. If the replacement plug needs a fuse, fit the same fuse as the original.

If a moulded plug comes off the mains lead, you should destroy it because a plug with cut wires is dangerous if it is put in a live plug socket. Do not leave it where a child might find it!

If you need to replace the plug fuse, fit a fuse that is approved by ASTA to BS1362 with the same rating as the original fuse.

Always replace the fuse cover. Never use a plug that does not have a cover.

## Warning - This printer must be earthed.

The wires in the mains lead are coloured in line with the following code :

<b>Green and Yellow:</b>	<b>Earth</b>
<b>Blue:</b>	<b>Neutral</b>
<b>Brown:</b>	<b>Live</b>

The colours of the wires in the mains lead of this printer may not match the coloured markings identifying the terminals in your plug.

If you need to fit a different plug, you should do the following.

Remove a bit of the outer cover of the lead, taking care not to damage the coloured insulation of the wires inside.

Cut each of the three wires to the appropriate length. If you can, leave the green and yellow wire longer than the others so that, if the lead is pulled out of the plug, the green and yellow wire will be the last to disconnect.

Remove a short section of the coloured insulation to expose the wires.

The wire which is coloured green and yellow must be connected to the terminal in the plug which is marked with the letter "E" or the safety earth symbol , or coloured green or green and yellow.

The wire, which is coloured blue, must be connected to the terminal, which is marked with the letter "N" or coloured black or blue.

The wire, which is coloured brown, must be connected to the terminal, which is marked with the letter "L" or coloured red or brown.

The outer cover of the lead must be secured inside the plug. The coloured wires should not hang out of the plug.

# Getting Started

## Carton Components

### Printer

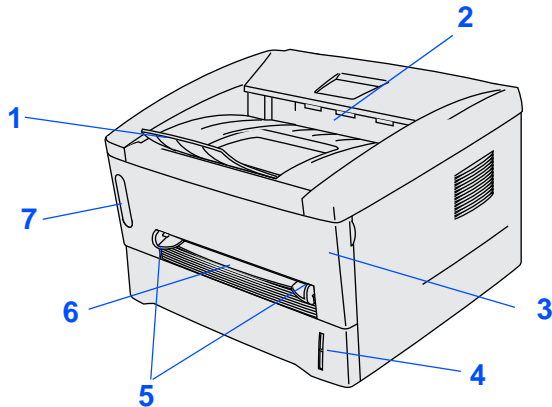

- 1 Face-down Output Tray Support Flap (Support Flap)
- 2 Face-down Output Tray (Top Output Tray)
- 3 Front Cover
- 4 Paper Tray
- 5 Manual Feed Paper Guides
- 6 Manual Feed Slot
- 7 Control Panel



**CD-ROM**  
(including User's Guide)

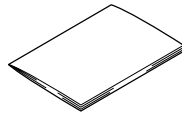

**Quick Setup Guide**

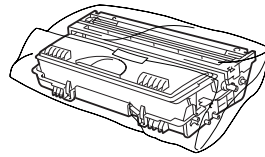

**Drum Unit Assembly  
(with Toner Cartridge  
included)**

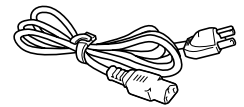

**AC Power Cord**

Carton components may differ from one country to another.  
Save all packing materials and the printer carton.



- *The interface cable is not a standard accessory. Please purchase the appropriate interface cable for the interface you intend to use (USB or Parallel).*
- *It's recommended to use a Parallel interface cable or USB interface cable that is not longer than 6 feet (2.0 meters).*
- *For Parallel interface cable use a shielded interface cable that is IEEE 1284-compliant.*
- *Do not connect the USB cable to the front of your PC or to the iMac's keyboard.*

# Control Panel

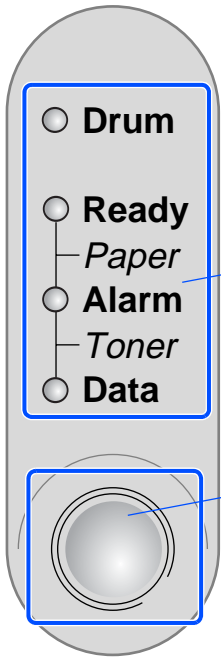

<b>Button</b>	Cancel Printing	Press the button one time and the printer will stop printing and eject the paper
	Reprinting	When the Data LED is off, press and hold the button until all the LEDs light. The printer will reprint the last job.

## Printer LED Indications

★: Blinking    ●: ON    ○: OFF

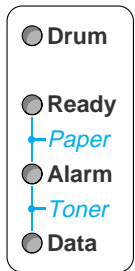

Printer LED	Sleep / OFF	Warming Up	Ready	Receiving Data	Data Remaining
Drum	○	○	○	○	○
Ready	○	★ Green	● Green	○	○
Alarm	○	○	○	○	○
Data	○	○	○	★ Orange	● Orange

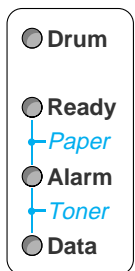

Printer LED	Near End of Life	Toner Low	Toner Empty	No Paper/ Paper Jam/ Misfeed	Service Error
Drum	● Orange	○	○	○	★ Orange
Ready / Paper	○	○	○	★ Green	★ Green
Alarm / Toner	○	★ Red	● Red	★ Red	★ Red
Data	○	★ Orange	● Orange	○	★ Orange
User's Guide	Chapter 5	Chapter 5	Chapter 5	Chapter 6	Chapter 6

# Supplied CD-ROM

You can find a variety of information on the CD-ROM.

## Windows®



## Macintosh®

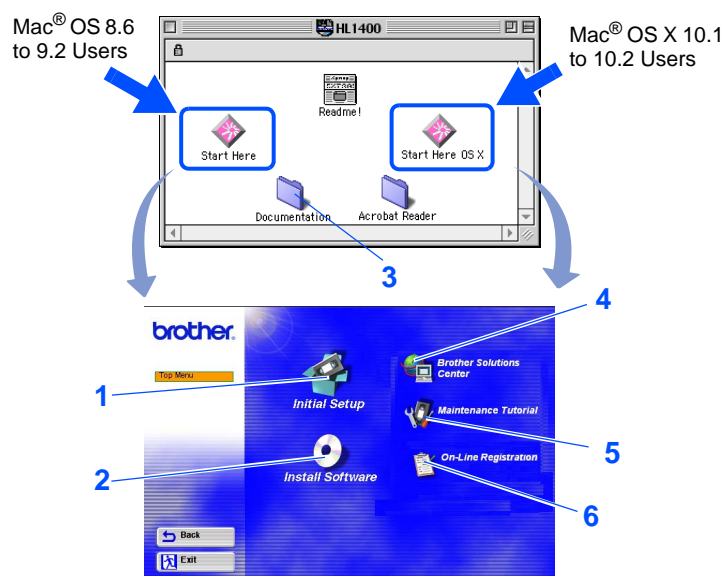

### 1 Initial Setup

Instructional movie for printer setup and driver installation.

### 2 Install Software

Installs the printer driver and utilities.

### 3 Documentation

View the Printer User's Guide and Quick Setup Guide in PDF format.  
(Viewer included)

### 4 Brother Solutions Center

The Brother Solutions Center (<http://solutions.brother.com>) is a one-stop resource for all your printer needs. Download the latest drivers and utilities for your printers, read the FAQs and troubleshooting tips, or learn about printer solutions.

### 5 Maintenance Tutorial

Instructional movie for printer maintenance.

### 6 On-Line Registration

Register your product on-line.



*For visually impaired users, we have prepared two HTML files on the supplied CD-ROM: `index_win.html` and `index_mac.html`. These files can be read by Screen Reader 'text-to-speech' software.*



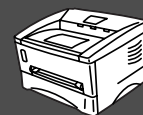

## 1 Insert the CD-ROM into the CD-ROM Drive

### For Windows® Users



Do NOT connect the interface cable. Connecting the interface cable is done when installing the driver.

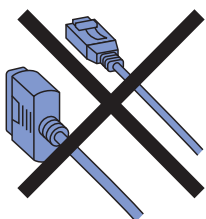

- 1 Insert the CD-ROM into your CD-ROM drive. The opening screen will appear automatically. Follow the on-screen instructions.



- 2 Click the **Initial Setup** icon on the menu screen.

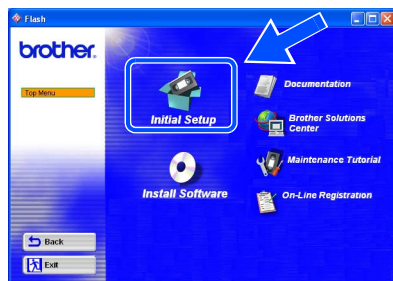

- 3 You can view the Initial Setup instructions and follow along from steps on page 8 to 11.

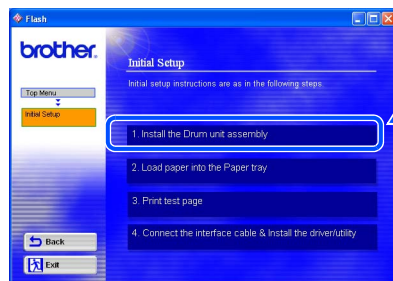

### For Macintosh® Users



Do NOT connect the interface cable. Connecting the interface cable is done when installing the driver.

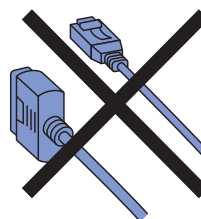

- 1 Insert the CD-ROM into your CD-ROM drive. Double-click the **Start Here** icon or **Start Here OS X** icon. Follow the on-screen instructions.

Mac® OS  
8.6 to 9.2  
Users

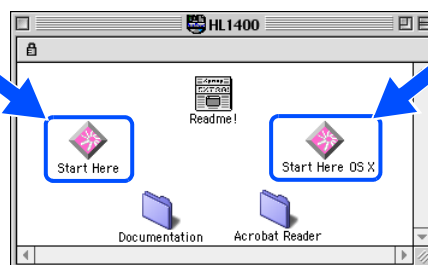

Mac® OS X  
10.1 to 10.2  
Users

- 2 Click the **Initial Setup** icon on the menu screen.



- 3 You can view the Initial Setup instructions and follow along from steps on page 8 to 11.

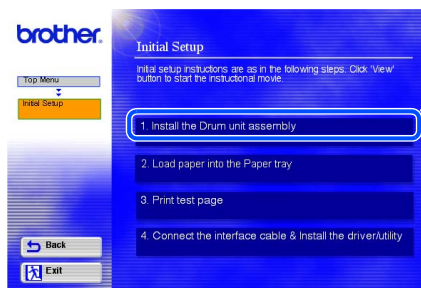

## 2 Install the Drum Unit Assembly



Do NOT connect the interface cable. Connecting the interface cable is done when installing the driver.

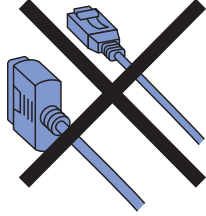

- 1 Open the front cover.

Front cover

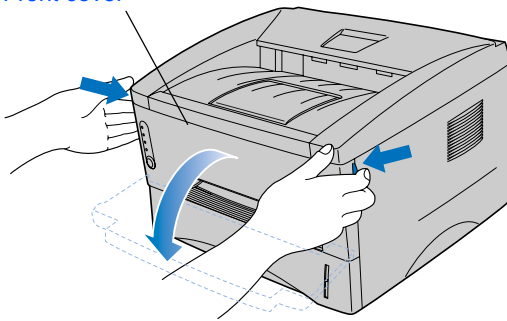

- 2 Unpack the drum unit assembly. Remove the protective part.

Drum unit assembly

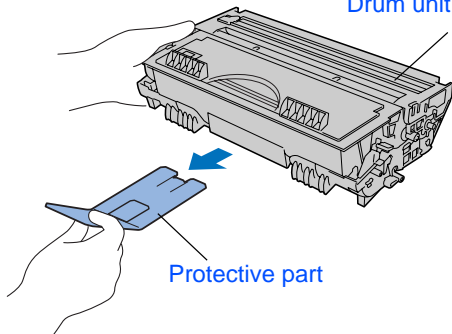

- 3 Rock it from side to side several times to distribute the toner evenly inside the assembly.

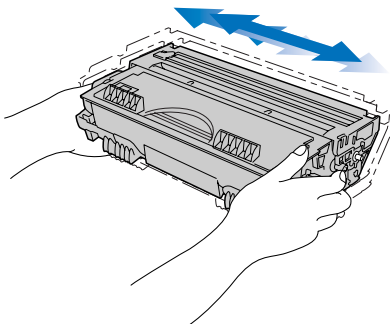

- 4 Put the drum unit assembly into the printer.

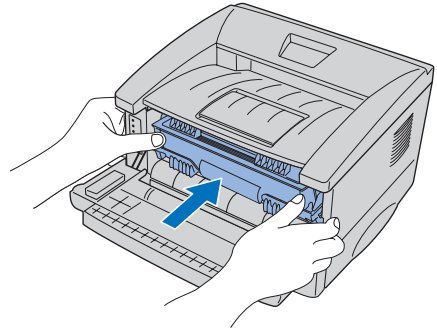
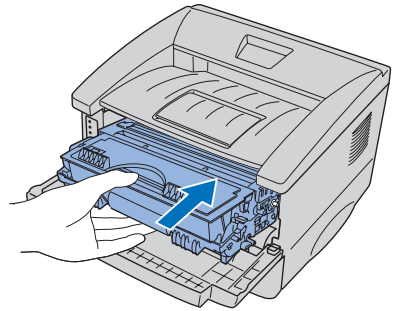

- 5 Close the front cover of the printer.

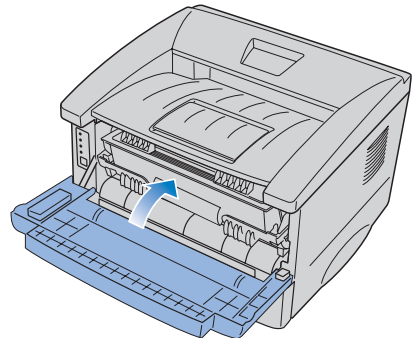



### 3 Load Paper in the Paper Tray

- 1 Pull the paper tray completely out of the printer.

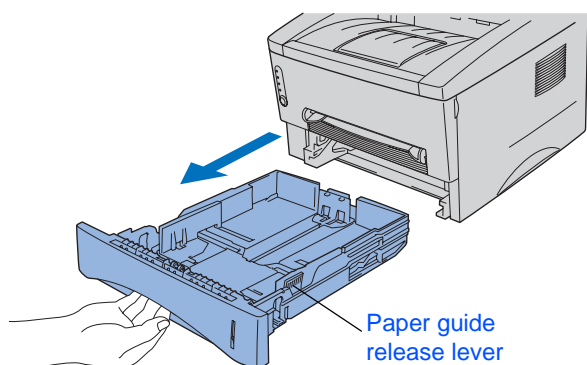

- 2 While pressing the paper guide release lever, slide the adjusters to fit the paper size. Check that the guides are firmly in the slots.

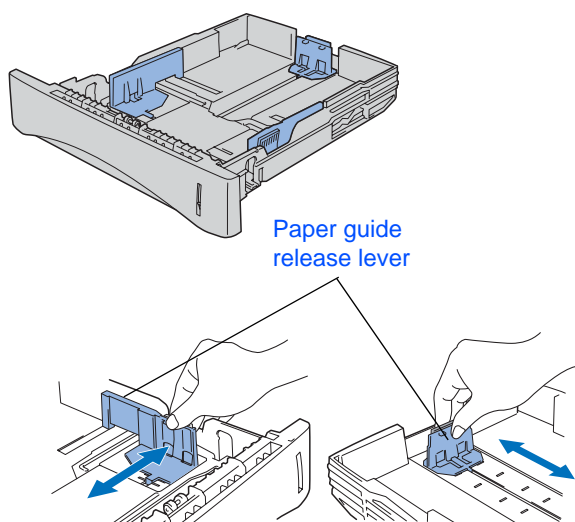

- 3 Fan the stack of paper well to avoid paper jams and misfeeds.

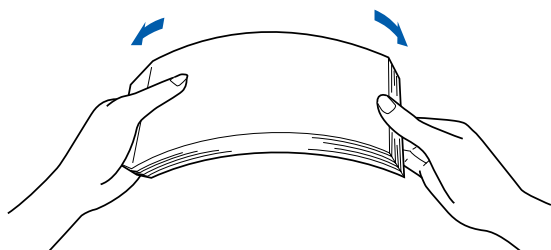

- 4 Put paper in the paper tray. Check that the paper is flat in the tray and below the maximum paper mark.

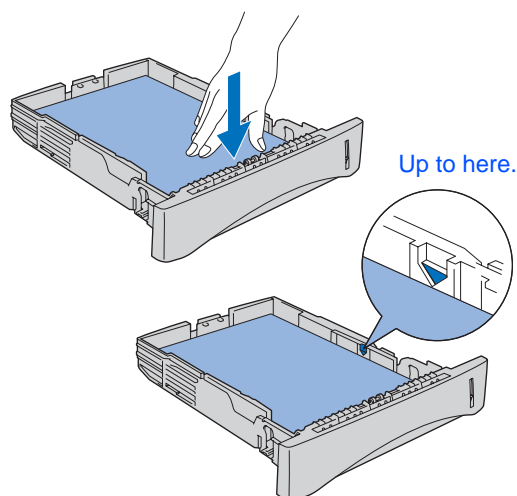

- 5 Put the paper tray firmly back in the printer.

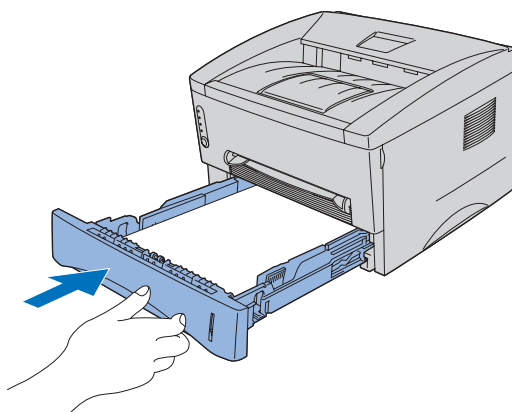

Go to the next page

Setting Up  
Your Printer

Windows®  
USB

Windows®  
Parallel

Installing the Driver

Macintosh®  
USB

## 4 Print a Test Page

 Do NOT connect the interface cable. Connecting the interface cable is done when installing the driver.

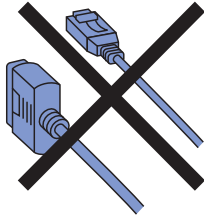

- 1 Make sure that the printer power switch is off.

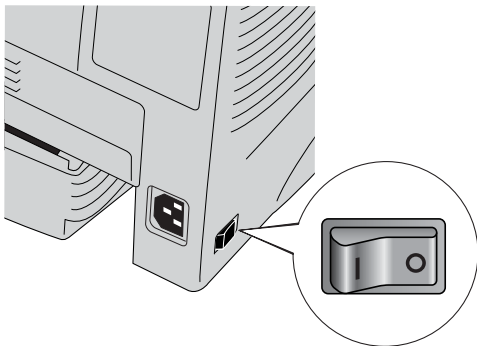

- 2 Connect the AC power cord to the printer, and then plug the AC power cord into an AC outlet.

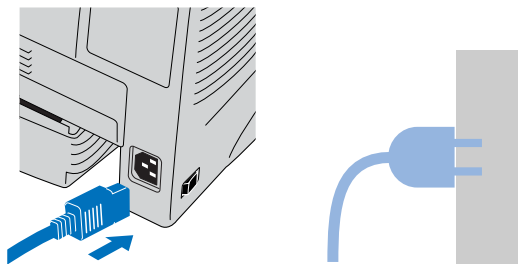

- 3 Turn the power switch on.



- 4 After the printer has finished warming up, the **Ready** LED stops blinking and stays green.

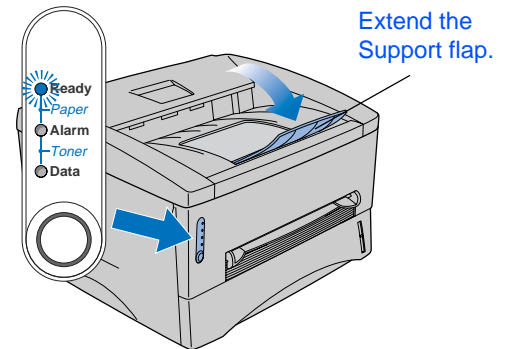

- 5 Press the control panel button. The printer prints a test page. Check that the test page has printed correctly.

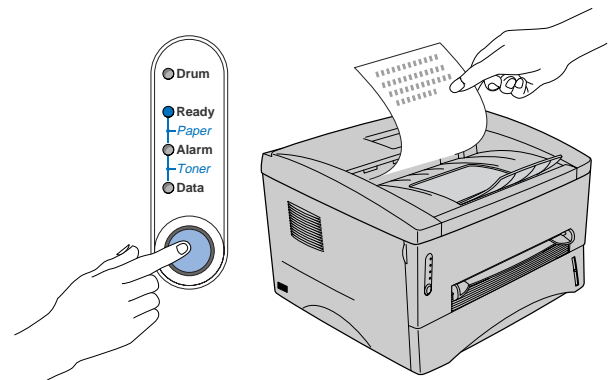

Go to the next page to install the driver.



Follow the appropriate instructions on this page for your operating system and interface cable. The screens for Windows® in this Quick Setup Guide are based on Windows® XP. The screens for Mac® OS X in this Quick Setup Guide are based on Mac® OS X 10.1.

Setting Up  
Your Printer

Windows®

 For USB Interface Cable Users .....Go to page 12

Windows®  
USB

 For Parallel Interface Cable Users.....Go to page 14

Windows®  
Parallel

Macintosh®

 For USB Interface Cable Users

- Mac® OS 8.6 to 9.2 Users ..... Go to page 16
- Mac® OS X 10.1 to 10.2 Users ..... Go to page 17

Macintosh®  
USB



## For USB Interface Cable Users

### 1. Installing the Driver and Connecting the Printer to Your PC



If the **Found New Hardware Wizard** appears on your PC, click the **Cancel** button.



- 1 Make sure the USB interface cable is **NOT** connected to the printer, and then begin installing the driver. If you have already connected the cable, remove it.

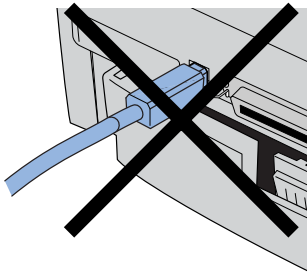

- 2 Click **Connect the interface cable & Install the driver/utility** from the **Initial Setup** menu.

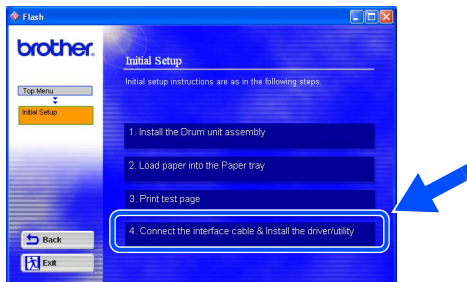

- 3 Select the **USB interface**.



- 4 Click the **Install** button.

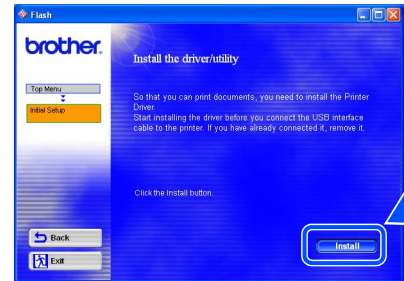

- 5 Click the **Next** button. Follow the on-screen instructions.

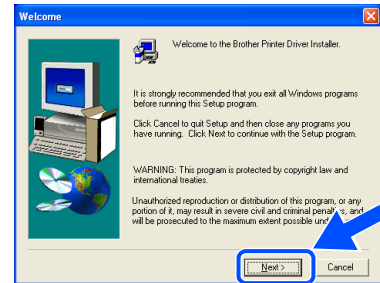

Continue to the next page

- 6 When this screen appears, make sure the printer power switch is on. Connect the USB interface cable to your PC, and then connect it to the printer. Click the **Next** button.

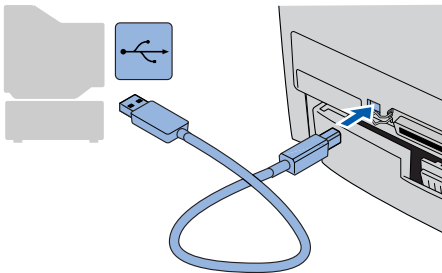
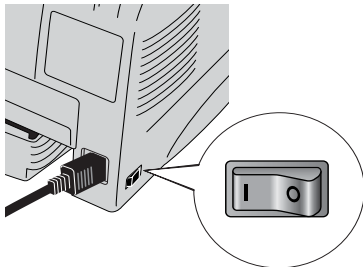
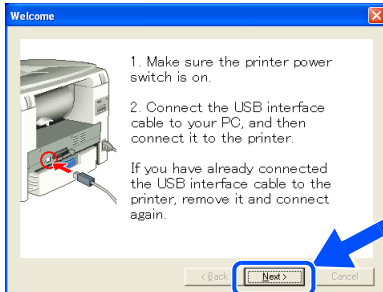

- 7 Click the **Finish** button.

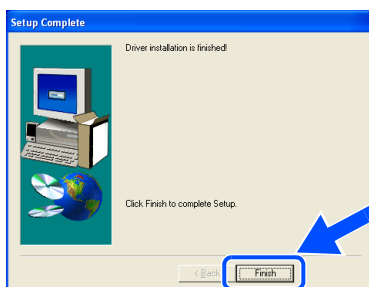

**OK!** For Windows® 98 / Me users:  
The Setup is now complete.

**▶▶** For Windows® 2000/XP users:  
Go to "2. Setting Your Printer as the Default Printer".

## 2. Setting Your Printer as the Default Printer (For Windows® 2000/XP Users Only)

- 1 Click **Start** and then **Printers and Faxes**.

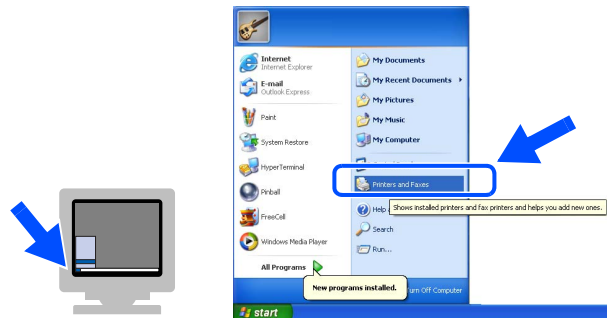

- 2 Select the **Brother HL-14XX series** icon.

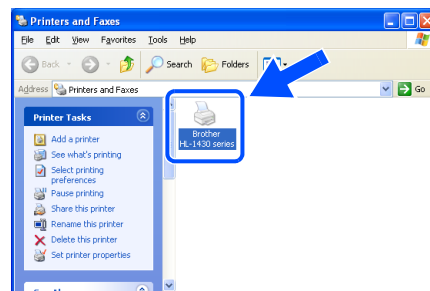

- 3 From the **File** menu, select **Set as Default printer**.

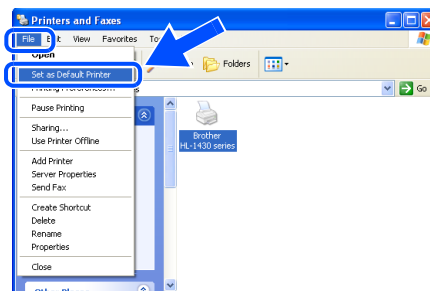

**OK!** The setup is now complete.



## For Parallel Interface Cable Users

### Connecting the Printer to Your PC and Installing the Driver

- 1 Click **Connect the interface cable & Install the driver/utility** from the **Initial Setup** menu.

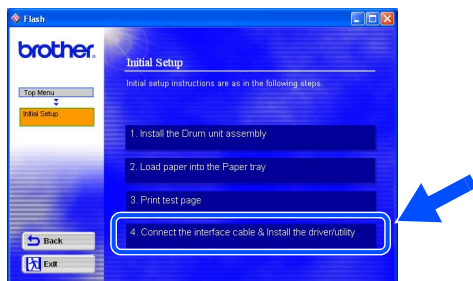

- 2 Select the **Parallel interface**.



- 3 Turn off the printer power switch.

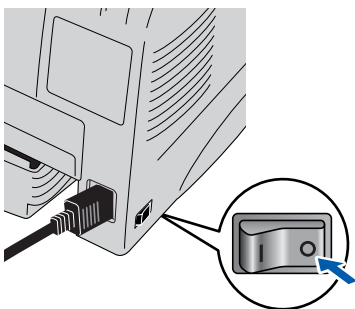

- 4 Connect the parallel interface cable to your PC, and then connect it to your printer.

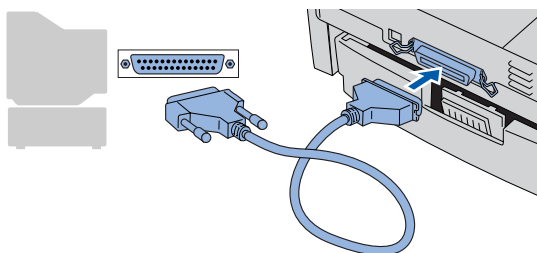

- 5 Turn on the printer power switch.

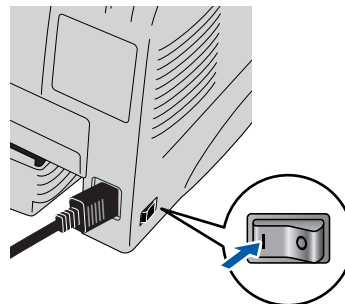

 If the **Found New Hardware Wizard** appears on your PC, click the **Cancel** button.

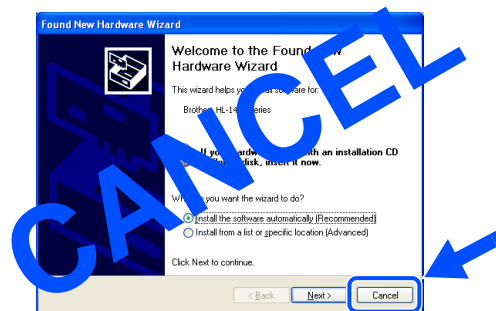

- 6 Click the **Next** button when the movie finishes.

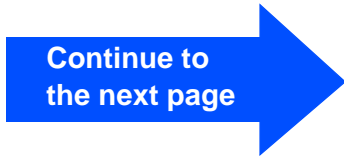

**Continue to the next page** 



- 7 Click the **Install** button.

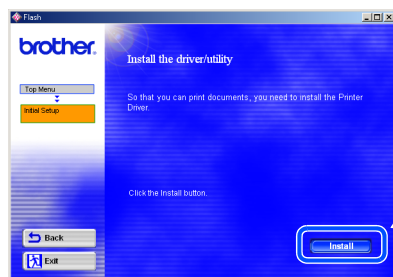

- 8 Click the **Next** button.  
Follow the on-screen instructions.

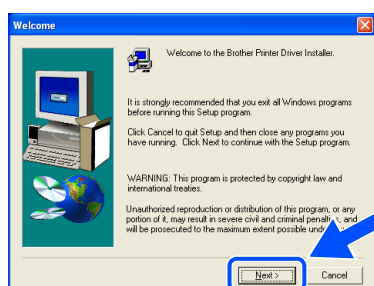

- 9 Click the **Finish** button.

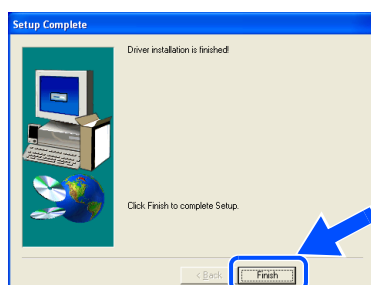

- OK! The Setup is now complete.



## For USB Interface Cable Users

### For Mac<sup>®</sup> OS 8.6 to 9.2 Users

#### Installing the Driver & Connecting the Printer to your Macintosh

- 1 Click **Connect the interface cable & Install the driver/utility** from the **Initial Setup** menu.

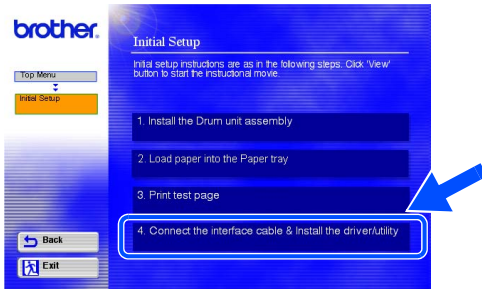

- 2 Follow the on-screen instructions, and restart your Macintosh.

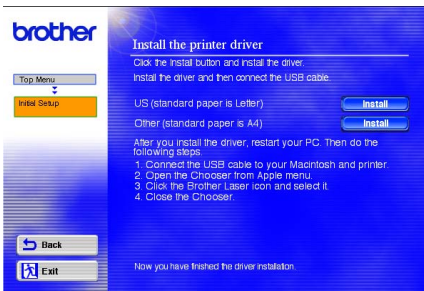

- 3 Make sure the printer power switch is on.

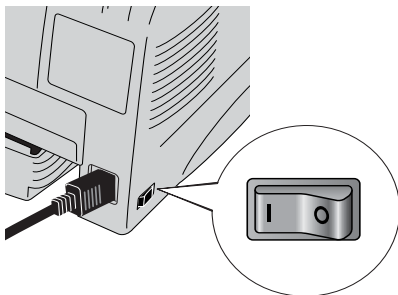

- 4 Connect the USB interface cable to your Macintosh, and then connect it to the printer.



*Do not connect the USB cable to the keyboard USB Port or a non-powered USB Hub.*

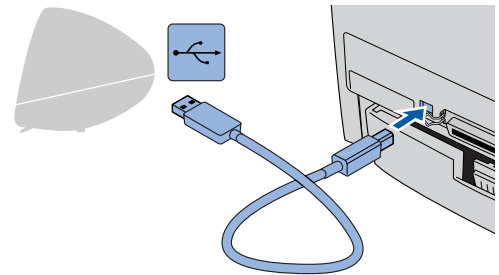

- 5 Open the **Chooser** from the **Apple** menu.



- 6 Click the **Brother Laser** and select **HL-14XX series**.  
Close the **Chooser**.

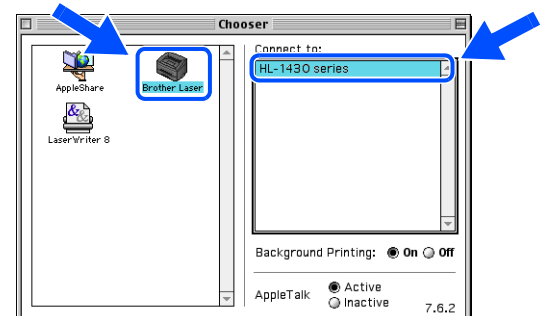

- OK!** The setup is now complete.



## For USB Interface Cable Users

# For Mac® OS X 10.1 to 10.2 Users

## Installing the Driver & Connecting the Printer to your Macintosh

- 1 Click **Connect the interface cable & Install the driver/utility** from the **Initial Setup** menu.

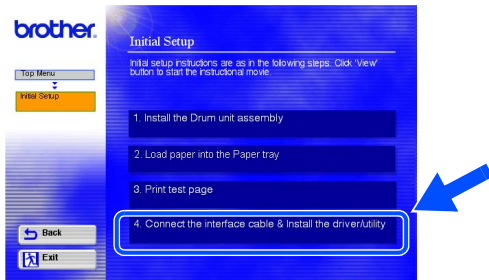

- 2 Click the **Install** button, and follow the on-screen instructions.



- 3 Make sure the printer power switch is on.

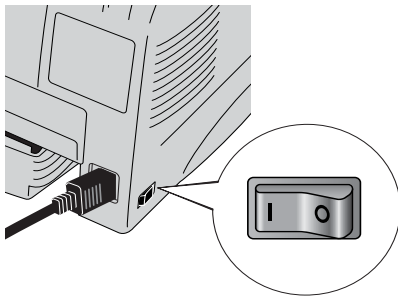

- 4 Connect the USB interface cable to your Macintosh, and then connect it to the printer.



*Do not connect the USB cable to the keyboard USB Port or a non-powered USB Hub.*

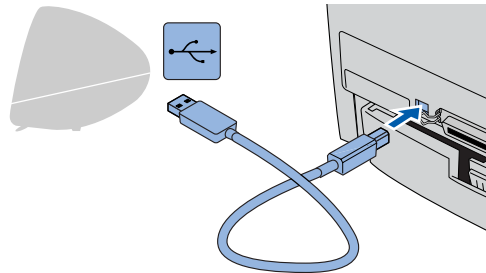

- 5 Select **Applications** from the **Go** menu.

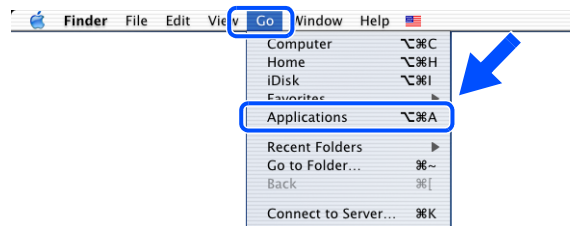

- 6 Open the **Utilities** folder.

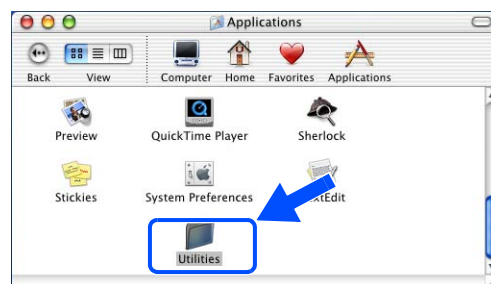

**Continue to  
the next page**

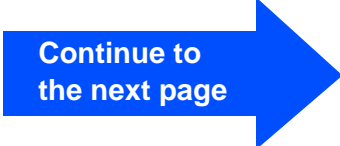

# Step 2

# Installing the Driver



## For USB Interface Cable Users

7 Open the **Print Center** icon.

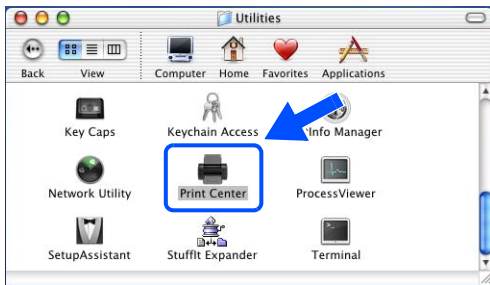

8 Click the **Add Printer...** button.

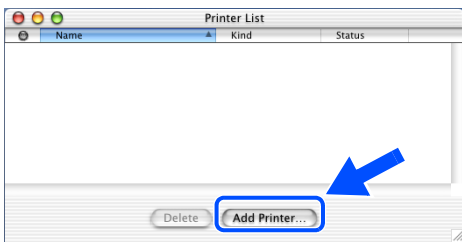

9 Select **USB**.

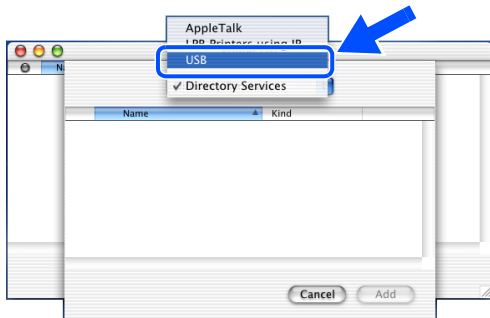

10 Select **HL-14XX series**, and then click the **Add** button.

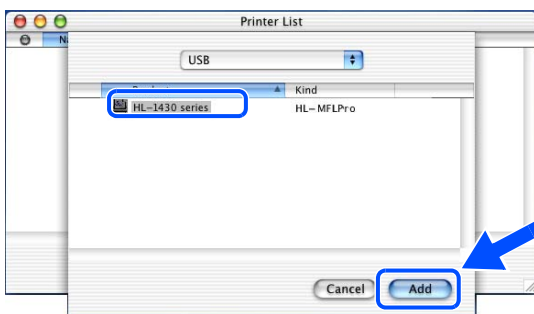

11 Select **Quit Printer Center** from the **Printer Center** menu.

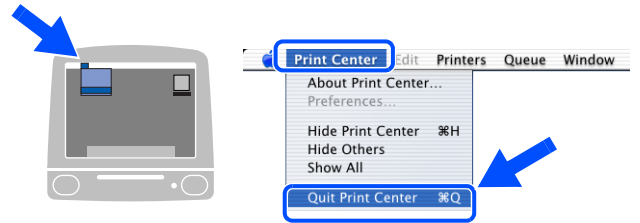

**OK!** The setup is now complete.

## Shipment of the Printer

If for any reason you must ship your Printer, carefully package the Printer in the original packing to avoid any damage during transit. It is strongly recommended that you save and use the original packaging. The Printer should also be adequately insured with the carrier.



**When shipping the Printer, the DRUM UNIT assembly and TONER CARTRIDGE must be removed from the Printer and placed in the foil bag. Failure to remove the unit and place it in the foil bag during shipping will cause severe damage to the Printer and may VOID THE WARRANTY.**

- 1 Turn off the printer power switch, and then unplug the AC power cord.

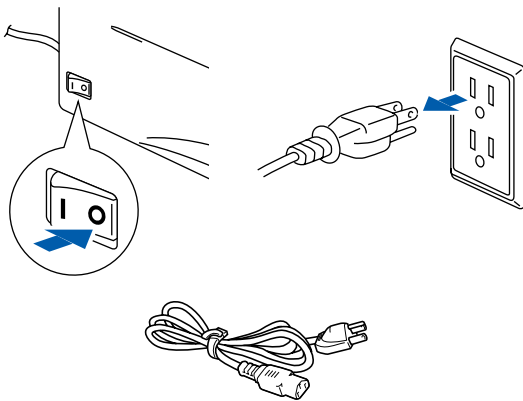

- 2 Remove the drum unit assembly. Place it in the foil bag and seal the bag completely.

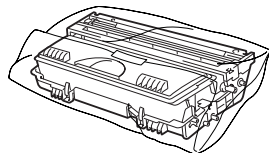

- 3 Re-pack the printer.

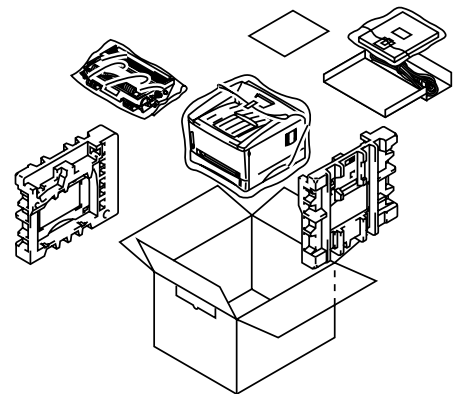

### Trademarks

The Brother logo is a registered trademark of Brother Industries, Ltd.

Windows® and Windows NT® are registered trademarks of Microsoft Corporation in the U.S and other countries.

Apple Macintosh, iMac, LaserWriter, and AppleTalk are trademarks of Apple Computer, Inc.

ENERGY STAR is a U.S. registered mark.

All other brand and product names mentioned in this User's Guide are registered

### Compilation and Publication

Under the supervision of Brother Industries Ltd., this manual has been compiled and published, covering the latest product descriptions and specifications.

The contents of this manual and the specifications of this product are subject to change without notice.

Brother reserves the right to make changes without notice in the specifications and materials contained herein and shall not be responsible for any damages (including consequential) caused by reliance on the materials presented, including but not limited to typographical and other errors relating to the publication.

This product is designed for use in a Professional Environment.

## Options

You can expand the capability of the printer by adding IR-1000.

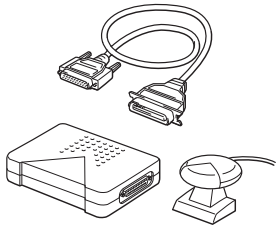

*User's Guide Chapter 4.*

<b>Ir-DA Interface</b> (Windows <sup>®</sup> 95/98/2000/Me and Windows NT <sup>®</sup> 4.0 only)
<b>IR-1000</b>

The IR-1000 connects to the parallel interface for infrared wireless printing.



*Optional accessories may differ from one country to another.*

**brother**<sup>®</sup>