









Thank you for choosing Brother, your support is important to us and we value your business. Your Brother product is engineered and manufactured to the highest standards to deliver reliable performance, day-in and day-out. Before using the printer, read this Quick Setup Guide for the correct setup and installation. To view the Quick Setup Guide in other languages, please visit <http://solutions.brother.com/>.

 <b>WARNING</b>	WARNING indicates a potentially hazardous situation which, if not avoided, could result in death or serious injuries.
 <b>CAUTION</b>	CAUTION indicates a potentially hazardous situation which, if not avoided, may result in minor or moderate injuries.
 <b>IMPORTANT</b>	IMPORTANT indicates a potentially hazardous situation which, if not avoided, may result in damage to property or loss of product functionality.
	Electrical Hazard icons alert you to a possible electrical shock.
	Hot Surface icons warn you not to touch printer parts that are hot.
 <b>Note</b>	Notes tell you how you should respond to a situation that may arise or give tips about how the operation works with other features.
 <b>User's Guide Network User's Guide</b>	Indicates reference to the User's Guide or Network User's Guide which is on the CD-ROM we have supplied.

# 1

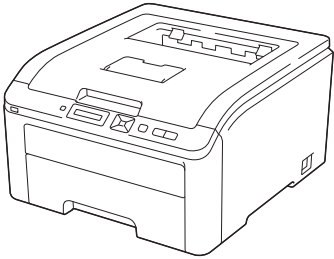
## Unpack the printer and check the components

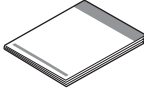
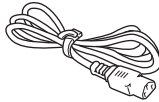
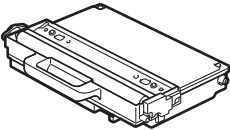
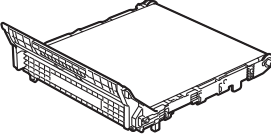
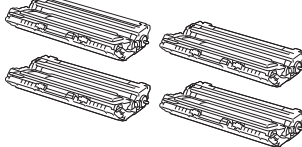
	 <b>CD-ROM</b> (including User's Guide and Network User's Guide)	 <b>Quick Setup Guide</b>	 <b>AC Power Cord</b>
	 <b>Waste Toner Box</b> (pre-installed)	 <b>Belt Unit</b> (pre-installed)	 <b>Drum Unit and Toner Cartridge Assemblies</b> (Black, Cyan, Magenta and Yellow)

## WARNING

- Plastic bags are used in the packaging of your printer. To avoid danger of suffocation, please keep these bags away from babies and children.
- This printer is heavy and weighs approximately 41.9 lb. (19.0 kg). To prevent injuries use at least two people to lift the printer. Be careful not to pinch your fingers when you put the printer back down.

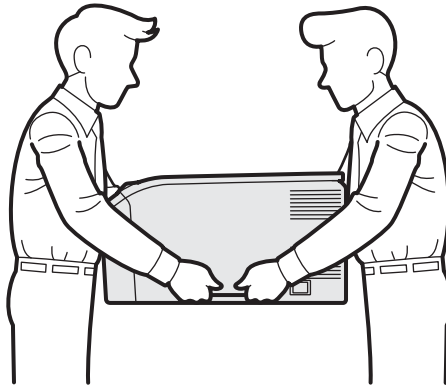

### Note

Keep a minimum gap around the printer as shown in the illustration.

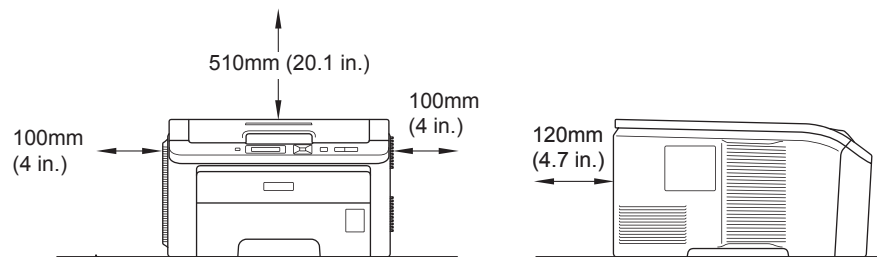

### Note

The interface cable is not a standard accessory. Buy the appropriate interface cable for the interface you want to use (USB or Network).

#### **USB cable**

- Please make sure you use a USB 2.0 (Type A/B) interface cable that is no longer than 6 feet (2 meters).
- When you use a USB cable, make sure you connect it to the USB port of your computer and not to a USB port on a keyboard or non-powered USB hub.

#### **Network cable**

Use a straight-through Category5 (or greater) twisted-pair cable for 10BASE-T or 100BASE-TX Fast Ethernet Network.

## 2

### Remove the packing material from the printer

#### ! IMPORTANT

- Save all packing material and the carton in case you have to ship your printer.
- DO NOT plug in the AC power cord yet.

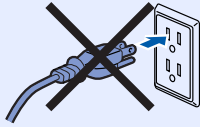

**a** Remove the packing tape from the outside of the printer.

**b** Fully open the top cover by lifting up on the handle 1.

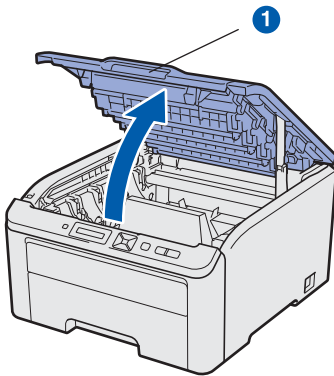

**c** Remove the packing material from the inside of the printer.

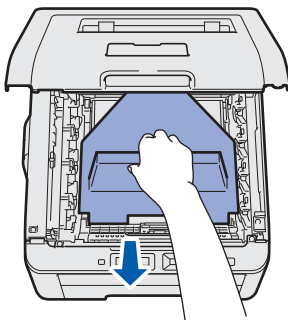

## 3

### Install the drum unit and toner cartridge assemblies

**a** Unpack the four drum unit and toner cartridge assemblies and gently shake each of them from side to side several times to distribute the toner evenly inside the assembly.

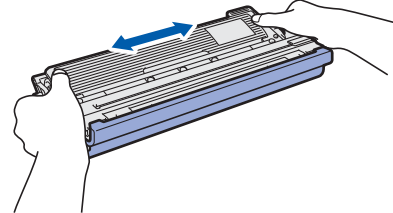

**b** Remove the protective cover by pulling on the tab as shown in the illustration.

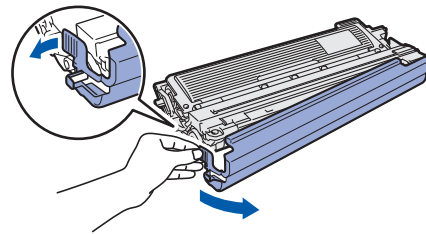

#### Note

*Do not touch the surface of the packing film. It may contain toner powder which can stain your skin and clothing.*

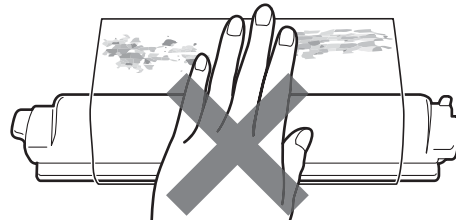

#### ! IMPORTANT

To avoid print quality problems, DO NOT touch the surface of the drum unit.

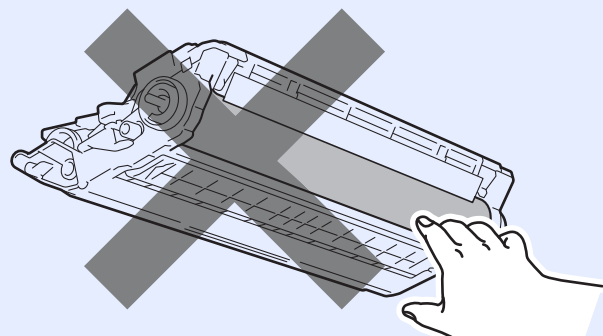

- C** Slide all four of the drum unit and toner cartridge assemblies into the printer as shown in the illustration. Make sure that you match the toner cartridge color to the same color label on the printer.

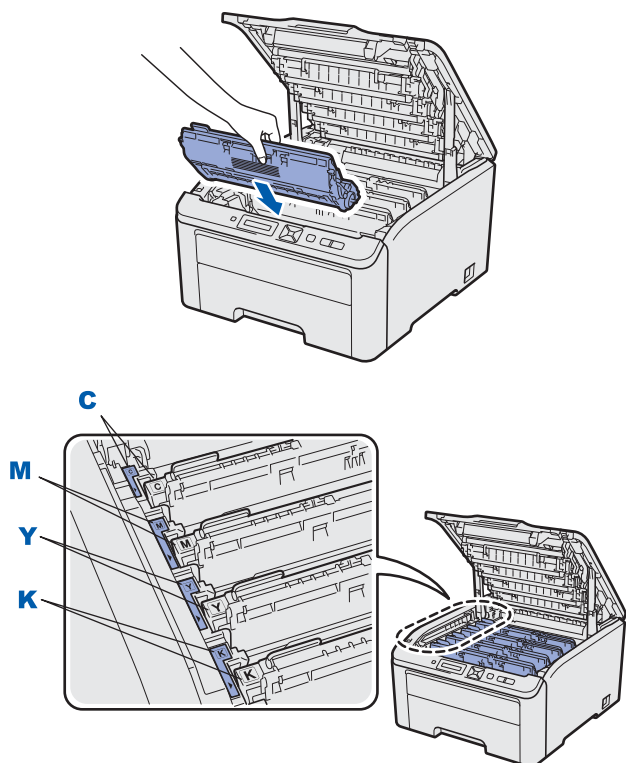

**C** - Cyan                      **Y** - Yellow  
**M** - Magenta                **K** - Black

- d** Close the top cover of the printer.

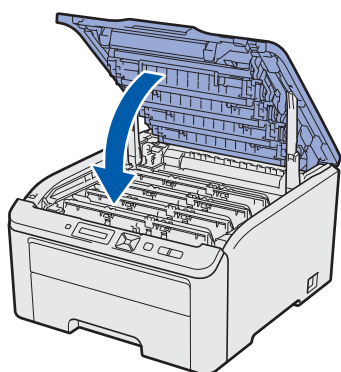

## 4 Load paper in the paper tray

- a** Pull the paper tray completely out of the printer.

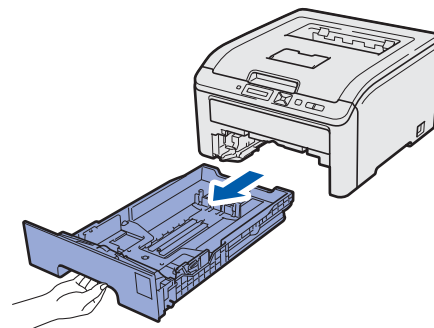

- b** While pressing the green paper-guide release lever ①, slide the paper guides to fit the paper size you are loading in the tray. Make sure that the guides are firmly in the slots.

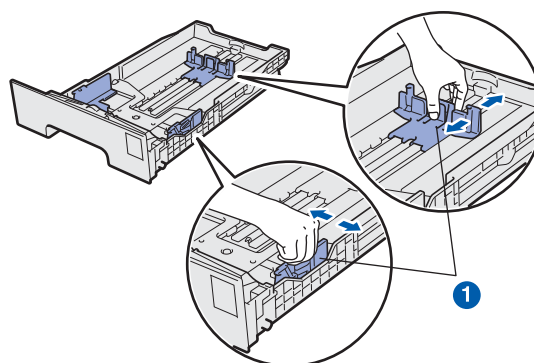

- c** Fan the stack of paper well to avoid paper jams and misfeeds.

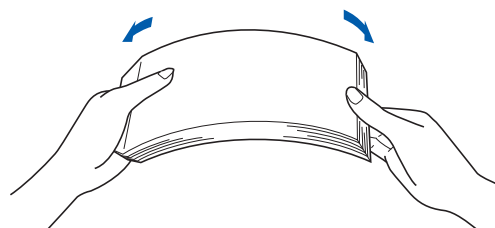

- d** Put paper in the tray, and make sure that the paper is below the maximum paper mark ①. The side to be printed on must be face down.

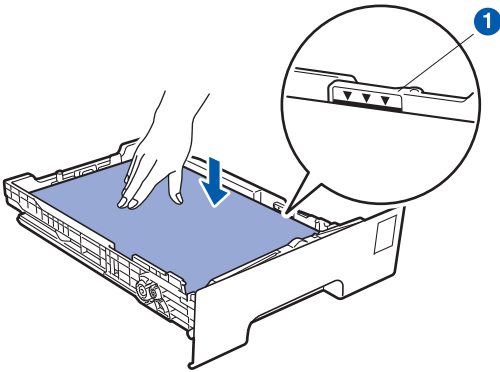

**! IMPORTANT**

**Make sure the paper guides touch the sides of the paper so it will feed properly.**

- e** Put the paper tray firmly back in the printer. Make sure that it is completely inserted into the printer.

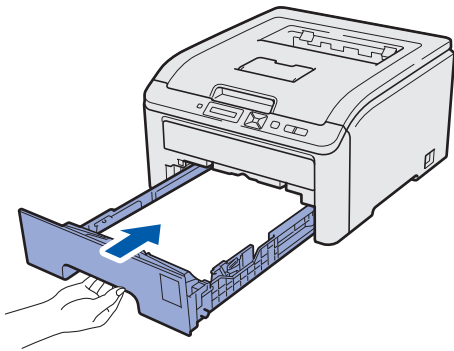

## 5 Print a test page

**! IMPORTANT**

**DO NOT connect the interface cable yet.**

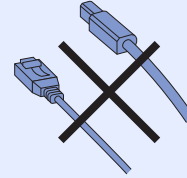

- a** Make sure that the printer power switch is off.



- b** Connect the AC power cord to the printer.

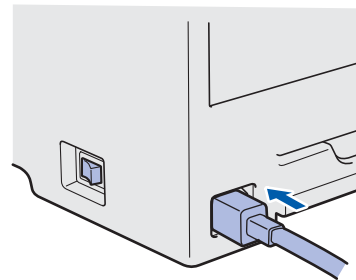

- c** Plug the AC power cord into an AC power outlet. Turn on the printer power switch.

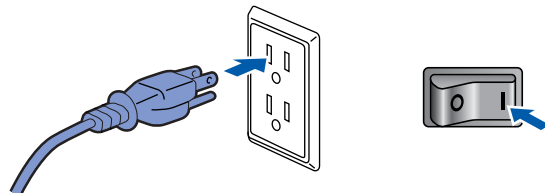

- d** After the printer has finished warming up, the LCD will show *Ready*.

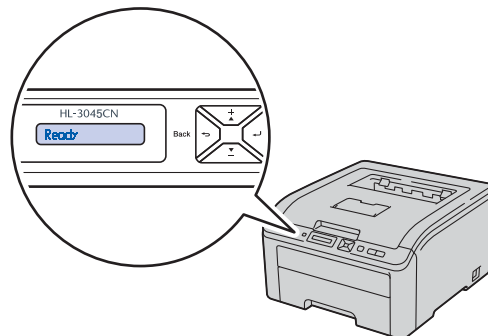

- e** Press **Go**. The printer prints a test page. Check that the test page has printed correctly.

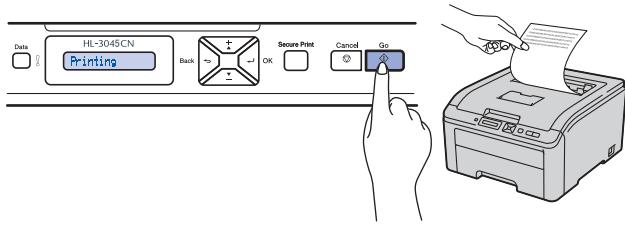

 **Note**

*This function will not be available after the first print job you send from your computer.*

## 6 Set your language on the control panel

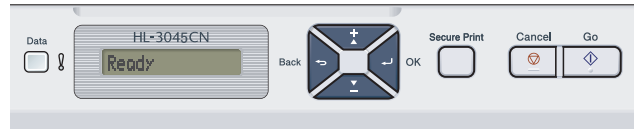

- a** Press **+** or **-** to choose **General Setup**. Press **OK**.

General Setup

- b** Press **OK** again.

Local Language

- c** Press **+** or **-** to choose your language. Press **OK** to accept.

English

- d** Press **Cancel** to exit from Menu.

**Now go to**

**Go to the next page to install the printer driver.**

# 7

## Choose your connection type

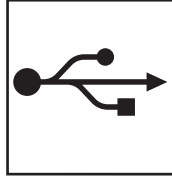
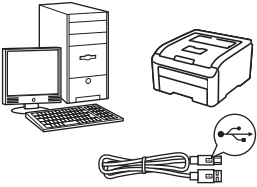

### For USB interface cable

Windows<sup>®</sup>, go to page 8  
Macintosh, go to page 10

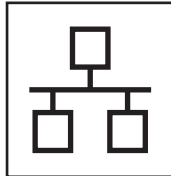
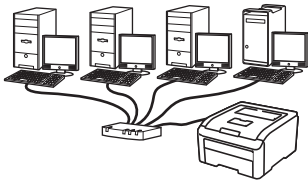

### For Wired Network

Windows<sup>®</sup>, go to page 11  
Macintosh, go to page 15

USB	Windows <sup>®</sup>
	Macintosh
Wired Network	Windows <sup>®</sup>
	Macintosh



## For USB Interface Cable Users

### 8 Install the printer driver and connect the printer to your computer

**IMPORTANT**  
DO NOT connect the USB interface cable yet.

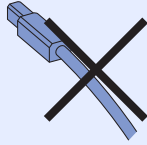

**Note**  
If the **Found New Hardware Wizard** appears on your computer, click **Cancel**.



**a** Turn off the printer power switch.



**b** Make sure the USB interface cable is **NOT** connected to the printer, and then begin installing the printer driver. If you have already connected the cable, remove it.

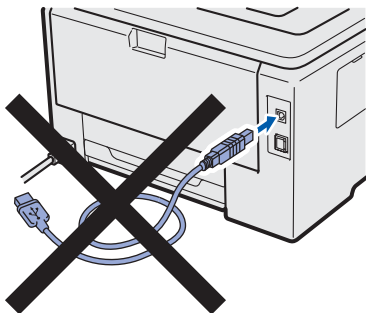

**c** Turn on your computer. (You must be logged on with Administrator rights.)

**d** Put the supplied CD-ROM into your CD-ROM drive. The opening screen will appear automatically. Choose your printer model and the language.

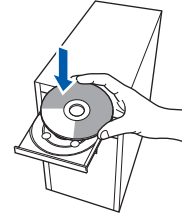

**Note**  
If the Brother screen does not appear automatically, go to **My Computer (Computer)**, double-click the CD-ROM icon, and then double-click **start.exe**.

**e** Click **Install Printer Driver** on the menu screen.

**Note**  
Choose the **Install Printer Driver** icon for your region.

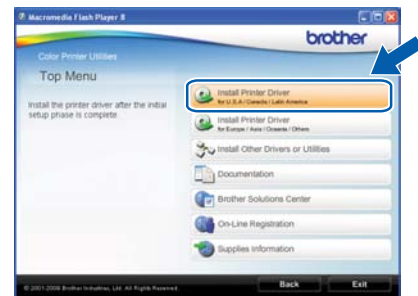

**f** Click **USB cable users**.



**Note**  
For Windows Vista® and Windows® 7, when the **User Account Control** screen appears, click **Continue** or **Yes**.

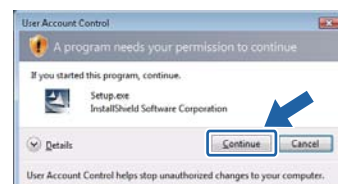







**g** When the **License Agreement** window appears, click **Yes** if you agree to the License Agreement.

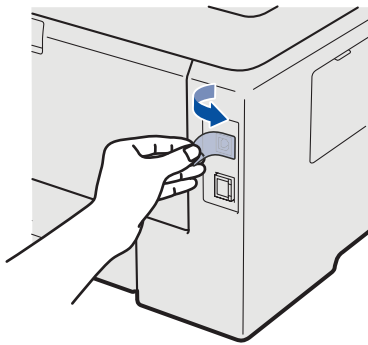

**h** Remove the label covering the USB interface connector.



**i** When this screen appears, turn on the printer's power switch. Connect the USB cable to the USB connector marked with the  symbol, and then connect the cable to the computer. Click **Next**.

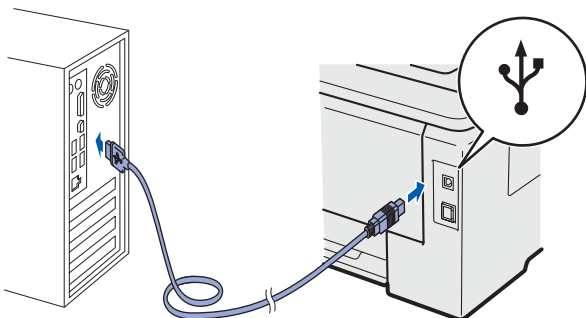
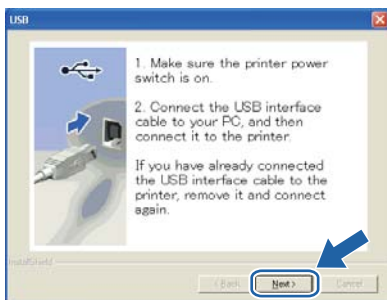

**! IMPORTANT**  
DO NOT try to cancel any of the screens during this installation.

**j** When this screen appears, click **Finish**.



**Note**

- If you want to register your product on-line, check **On-Line Registration**.
- If you do not want to set your printer as Default printer, uncheck **Set as Default Printer**.
- If you want to disable the Status Monitor, uncheck **Enable Status Monitor**.



**Finish** The installation is now complete.



**Note**

**XML Paper Specification Printer Driver**  
The XML Paper Specification Printer Driver is the most suitable driver for Windows Vista® and Windows® 7 when printing from the applications that use the XML Paper Specification documents. Please download the latest driver by accessing the Brother Solutions Center at <http://solutions.brother.com/>.



## For USB Interface Cable Users

### 8 Connect the printer to your Macintosh and install the driver

**a** Remove the label covering the USB interface connector.

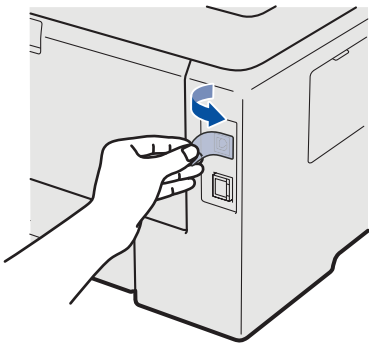

**b** Connect the USB cable to the USB connector marked with a  symbol, and then connect the cable to your Macintosh.

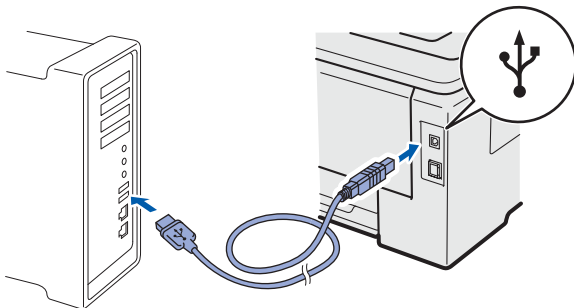

**! IMPORTANT**

- **DO NOT** connect the printer to a USB port on a keyboard or a non-powered USB hub.
- Connect the printer directly to your computer.

**c** Make sure the printer power switch is on.



**d** Turn on your Macintosh. Put the supplied CD-ROM into your CD-ROM drive.

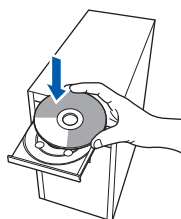

**e** Double-click the **Start Here OSX** icon. Follow the on-screen instructions.



#### Note

*It may take a few minutes for installation to complete.*

**f** Follow the on-screen instructions until this screen appears. Choose your machine from the list, and then click **OK**.



**g** When this screen appears, click **Next**.

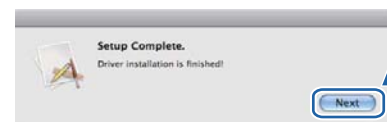

#### Note

*When the **Brother Support** screen appears, make your selection and follow the on-screen instructions.*

**Finish** The installation is now complete.

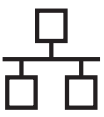

## For Wired Network Interface Cable Users

### 8 For Peer-to-Peer network printer users

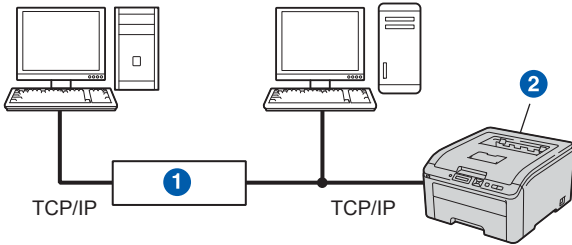

- 1 Router
- 2 Network printer

#### Note

- If you are going to connect the printer to your network, we recommend that you contact your system administrator prior to installation or see the Network User's Guide on the CD-ROM.
- If you are using Windows® Firewall or a firewall function of anti-spyware or antivirus applications, temporarily disable them. Once you are sure that you can print, configure the software settings following the instructions.

### Connect the printer to your network and install the driver

- a Connect the network interface cable to the LAN connector marked with a  symbol and then connect it to a free port on your hub.

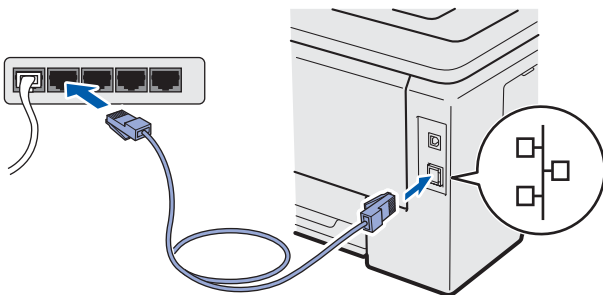

- b Make sure the printer power switch is on.



- c Turn on your computer. (You must be logged on with Administrator rights.)

- d Put the supplied CD-ROM into your CD-ROM drive. The opening screen will appear automatically. Choose your printer model and the language.

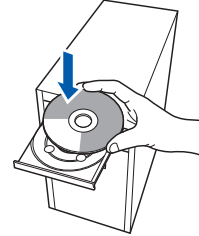

#### Note

If the Brother screen does not appear automatically, go to **My Computer (Computer)**, double-click the CD-ROM icon, and then double-click **start.exe**.

- e Click **Install Printer Driver** on the menu screen.

#### Note

Choose the **Install Printer Driver** icon for your region.



- f Click **Network cable users**.



#### Note

For Windows Vista® and Windows® 7, when the **User Account Control** screen appears, click **Continue** or **Yes**.

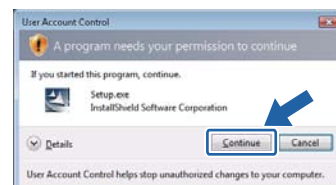

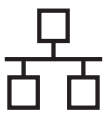

**g** When the **License Agreement** window appears, click **Yes** if you agree to the License Agreement.



**h** Choose **Brother Peer-to-Peer Network Printer**, and then click **Next**.

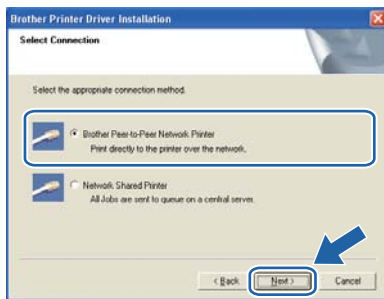

**i** Choose **Search the network for devices and choose from a list of discovered devices (Recommended)**. Or enter your printer's IP Address or its node name. Click **Next**.

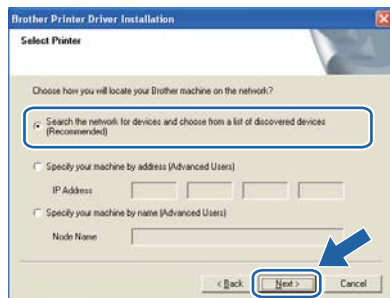

**Note**

You can find your printer's IP Address and the node name by printing out the **Printer Settings Page**. See **Print the Printer Settings Page** on page 16.

**j** Choose your printer, and then click **Next**.

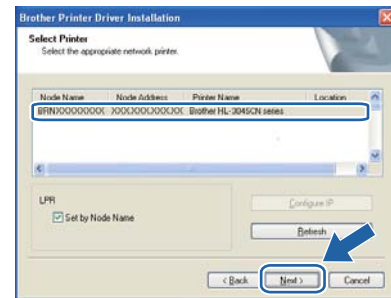

**Note**

If your printer takes a long time (about 1 minute) to appear on the list, click **Refresh**.

**k** Click **Finish**.

**Note**

- If you want to register your product on-line, check **On-Line Registration**.
- If you do not want to set your printer as Default printer, uncheck **Set as Default Printer**.
- If you want to disable the Status Monitor, uncheck **Enable Status Monitor**.
- If you disable your Personal Firewall software (e.g. Windows® Firewall), turn it back on.



**Finish**

The installation is now complete.

**Note**

**XML Paper Specification Printer Driver**

The XML Paper Specification Printer Driver is the most suitable driver for Windows Vista® and Windows® 7 when printing from the applications that use the XML Paper Specification documents. Please download the latest driver by accessing the Brother Solutions Center at <http://solutions.brother.com/>.

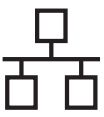

## 8

### For shared network printer users

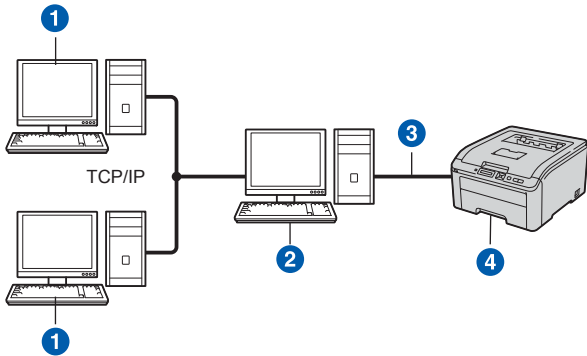

- 1 Client computer
- 2 Also known as "Server" or "Print server"
- 3 TCP/IP or USB
- 4 Printer

#### Note

If you are going to connect to a shared printer on your network, we recommend that you ask your system administrator about the queue or share name for the printer prior to installation.

#### Install the driver and choose the correct printer queue or share name

- a Turn on your computer. (You must be logged on with Administrator rights.)
- b Put the supplied CD-ROM into your CD-ROM drive. The opening screen will appear automatically. Choose your printer model and the language.

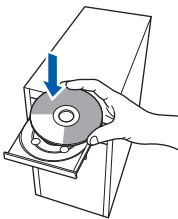

#### Note

If the Brother screen does not appear automatically, go to **My Computer (Computer)**, double-click the CD-ROM icon, and then double-click **start.exe**.

- c Click **Install Printer Driver** on the menu screen.

#### Note

Choose the **Install Printer Driver** icon for your region.



- d Click **Network cable users**.



#### Note

For Windows Vista® and Windows® 7, when the **User Account Control** screen appears, click **Continue** or **Yes**.

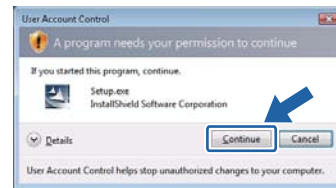

- e When the **License Agreement** window appears, click **Yes** if you agree to the License Agreement.



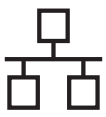

- f** Choose **Network Shared Printer**, and then click **Next**.

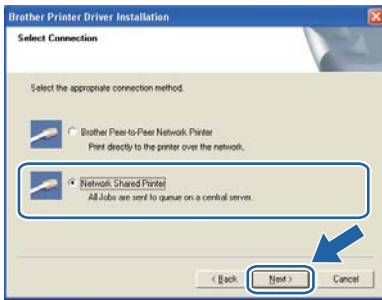

- g** Choose your printer's queue, and then click **OK**.

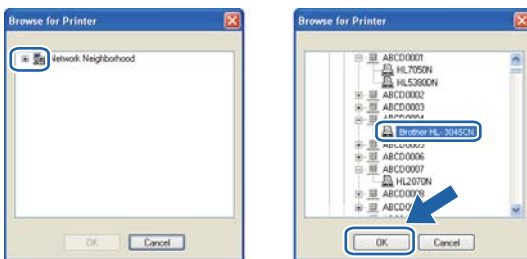

**Note**

Contact your administrator if you do not know the location or the name of the printer in the network.

- h** When this screen appears, click **Finish**.

**Note**

- If you want to register your product on-line, check **On-Line Registration**.
- If you do not want to set your printer as Default printer, uncheck **Set as Default Printer**.
- If you want to disable the Status Monitor, uncheck **Enable Status Monitor**.



**Finish**

The installation is now complete.

**Note**

**XML Paper Specification Printer Driver**

The XML Paper Specification Printer Driver is the most suitable driver for Windows Vista® and Windows® 7 when printing from the applications that use the XML Paper Specification documents. Please download the latest driver by accessing the Brother Solutions Center at <http://solutions.brother.com/>.

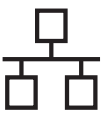

## For Wired Network Interface Cable Users

### 8 Connect the printer to your Macintosh and install the driver

- a** Connect the network interface cable to the LAN connector marked with a  symbol and then connect it to a free port on your hub.

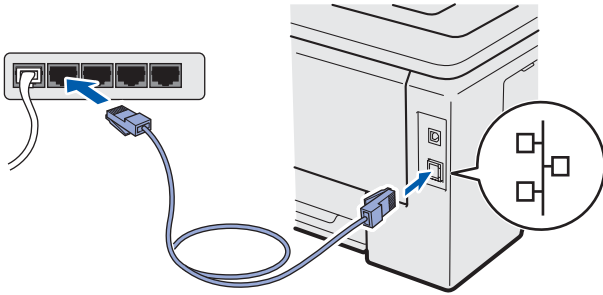

- b** Make sure the printer power switch is on.



- c** Turn on your Macintosh. Put the supplied CD-ROM into your CD-ROM drive.

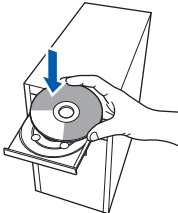

- d** Double-click the **Start Here OSX** icon. Follow the on-screen instructions.



#### Note

*It may take a few minutes for installation to complete.*

- e** Follow the on-screen instructions until this screen appears. Choose your machine from the list, and then click **OK**.



#### Note

- If there is more than one of the same model connected on your network, the MAC Address (Ethernet Address) will be displayed after the model name.
- You can find your machine's MAC Address (Ethernet Address) and IP Address by printing out the Printer Settings Page. See Print the Printer Settings Page on page 16.

- f** When this screen appears, click **Next**.

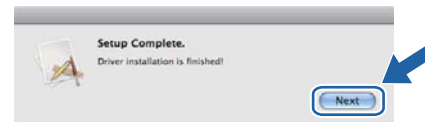

#### Note

*When the **Brother Support** screen appears, make your selection and follow the on-screen instructions.*

## Finish

**The installation is now complete.**

#### Note

*If you use a specified IP Address for the machine, you must set the Boot Method to Static by using the BRAdmin Light. For more information, See Configuring your machine for a network in the Network User's Guide.*

## Web Based Management (web browser)

The Brother print server is equipped with a web server that allows you to monitor its status or change some of its configuration settings, using HTTP (Hyper Text Transfer Protocol).

### Note

- The login name for the Administrator is '**admin**' (case sensitive) and the default password is '**access**'.
- We recommend Microsoft® Internet Explorer® 6.0 (or greater) or Firefox 1.0 (or greater) for Windows® and Safari 4.0/5.0 for Macintosh. Please also make sure that JavaScript and Cookies are always enabled in whichever browser you use. To use a web browser, you will need to know the IP Address of the print server. The IP Address of the print server is listed on the Print Setting Page.



- a** Type `http://printer_ip_address/` into your browser.  
(Where `printer_ip_address` is the IP Address or the print server name)

■ For example: `http://192.168.1.2/`



See Chapter 10 of the Network User's Guide.

## Reset the network settings to the factory default

To reset all network settings of the print server to its factory default, follow the steps below.

- a** Press the + or - to choose `Network`. Press **OK**.

`Network`

- b** Press the + or - to choose `Factory Reset`. Press **OK**.

`Factory Reset`

- c** Press **OK** again.

`Restart Printer?`

## Print the Printer Settings Page

The Printer Settings Page lists all the current printer settings, including network settings. To print the printer settings page:

- a** Press the + or - to choose `Machine Info..` Press **OK**.

`Machine Info.`

- b** Press **OK** again.

`Print Settings`

- c** Press **OK** again to print the Printer Settings Page.



### Note

If the IP Address on the Printer Settings Page shows `0.0.0.0`, wait for one minute and try again.



## Compilation and Publication

Under the supervision of Brother Industries, Ltd., this manual has been compiled and published, covering the latest product descriptions and specifications.

The contents of this manual and the specifications of this product are subject to change without notice.

Brother reserves the right to make changes without notice in the specifications and materials contained herein and shall not be responsible for any damages (including consequential) caused by reliance on the materials presented, including but not limited to typographical and other errors relating to the publication.

## Choosing a location

Put your product on a flat, level, stable surface that is free of vibration and shocks, such as a desk. Put the product near a standard grounded AC power outlet. Choose a location where the temperature remains between 50°F and 90.5°F (10°C and 32.5°C) and the humidity is between 20% to 80% (without condensation).

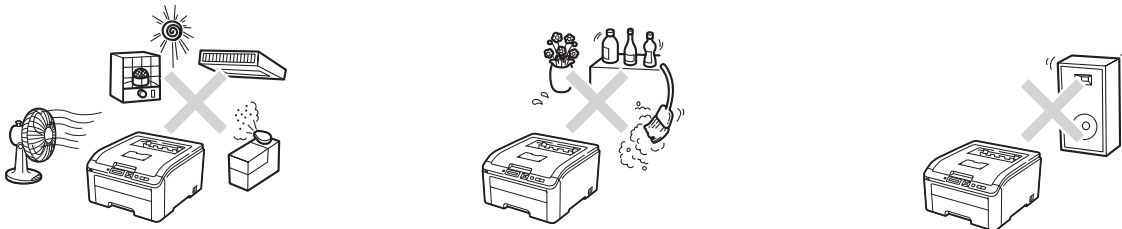

### **!** WARNING

- **DO NOT** expose the product to direct sunlight, excessive heat, open flames, corrosive gasses, moisture or dust. Doing so may create a risk of an electrical short or fire. It may also damage the product and/or render it inoperable.
- **DO NOT** place the product near heaters, air conditioners, electrical fans, refrigerators, or water. Doing so may create the risk of a short circuit or fire, should water come into contact with the product (including condensation caused by heating, air conditioning, or ventilation equipment).
- **DO NOT** place the product near chemicals. Should the chemicals come into contact with the product, there may be a risk of fire. The chemicals may also cause the product to malfunction or become discolored.
- **DO NOT** put the product in a location where any slot or opening in the product is obstructed or blocked. These slots and openings are provided for ventilation. Blocking the product's ventilation could create a risk of overheating and/or fire.

Instead:

- Keep a gap of roughly 4 inches. (100 mm) between the ventilation hole and the wall.
- Place the product on a solid surface.
- **DO NOT** place the product on a bed, sofa, rug, or other similar soft surface.
- **DO NOT** place this product near or over a radiator or heater.
- **DO NOT** place this product in a "built-in" installation unless adequate ventilation is provided.
- **DO NOT** put objects on top of the product. Doing so could increase the risk of overheating and/or fire should the product malfunction.
- **DO** install your product near an AC power outlet that is easily accessible. In the event of an emergency, easy access to the plug and outlet will allow you to shut off power to the product quickly and completely.
- Plastic bags are used in the packing of your product and drum unit. Plastic bags are not toys. To avoid the danger of suffocation, keep these bags away from babies and children and dispose of them properly.

## **⚠ CAUTION**

Avoid placing your product in a high-traffic area. If you must place it in a high-traffic area, ensure that the product is in a safe location where it cannot be accidentally knocked-over, which could cause injury to you and serious damage to the product. Also ensure that cords are secured so as not to pose a tripping hazard. **DO NOT** place this product on an unstable cart, stand, or table. The product is heavy and may fall, causing injury to you, and serious damage to the product.

## **❗ IMPORTANT**

- **DO NOT** place your product next to devices that contain magnets or generate magnetic fields. Doing so may interfere with the operation of the product, causing print quality problems.
- **DO NOT** place your product next to sources of interference, such as speakers or the base units of non Brother cordless telephones. Doing so may interfere with the operation of the product's electronic components.
- **DO NOT** connect your product to an AC power outlet controlled by wall switches or automatic timers. Disruption of power can delete information from the product's memory.
- **DO NOT** connect your product to an AC power outlet on the same circuit as large appliances or other equipment that requires a significant amount of electricity to operate. Operating this product in conjunction with the other product(s) could create an overvoltage, tripping your circuit breaker or blowing your fuse.

## To use the product safely

Please keep these instructions for later reference and read them before attempting any maintenance. If you do not follow these safety instructions, there is a possibility of a fire, electrical shock, burn or suffocation.

## **⚠ WARNING**

### ELECTRICAL HAZARDS

*Failure to follow the warnings in this section may create the risk of an electrical shock. In addition, you could create an electrical short, which may create the risk of a fire.*



- There are high voltage electrodes inside the product. Before you access the inside of the product, including for routine maintenance such as cleaning, make sure you have unplugged the power cord from the AC power outlet, as well as any Ethernet (RJ-45) cable from the product. Never push objects of any kind into this product through cabinet slots, since they may touch dangerous voltage points or short out parts.

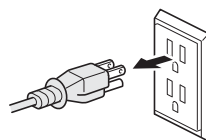

# Other Information



- **DO NOT handle the plug with wet hands.**

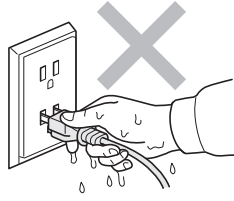

Always make sure the plug is fully inserted. **DO NOT** use the product or handle the cord if the cord has become worn or frayed.

- **DO NOT touch this product during an electrical storm.**
- **DO NOT allow this product to come into contact with water. This product should not be used around standing water including a bathtub, sink, or swimming pool, around appliances containing water including a refrigerator, or in a wet basement.**
- **This product should be connected to an AC power source within the range indicated on the rating label. DO NOT connect it to a DC power source or inverter. If you are not sure what kind of power source you have, contact a qualified electrician.**
- **Always disconnect all cables from the wall outlet before servicing, modifying or installing the equipment.**
- **Power Cord Safety:**
  - This product is equipped with a 3-wire grounded plug. This plug will only fit into a grounded power outlet. This is a safety feature. If you are unable to insert the plug into the outlet, call your electrician to replace your obsolete outlet. **DO NOT** defeat the purpose of the grounded plug.
  - Use only the power cord supplied with this product.
  - **DO NOT** allow anything to rest on the power cord. **DO NOT** place this product where people can walk on the cord. **DO NOT** place this product in a position where the cord is stretched or strain is otherwise put on the cord. Doing so may cause the cord to become worn or frayed.
  - If an extension cord is used with this product, make sure that the total ampere ratings on the products plugged into the extension cord do not exceed the extension cord ampere rating. Also, make sure that the total of all products plugged into the AC power outlet does not exceed 15 amperes.
  - The power cord, including extensions, should be no longer than 16.5 feet (5 meters).
  - We **DO NOT** advise using an extension cord.

## FIRE HAZARDS

- **DO NOT use flammable substances, any type of spray, or an organic solvent/liquid that containing alcohol or ammonia to clean the inside or outside of the product. Doing so could cause a fire. Instead, use only a dry, lint-free cloth. See *Routine Maintenance* in the *User's Guide* for more information on how to clean the product.**



- **DO NOT attempt to operate this product with a paper jam or with stray pieces of paper inside the product. Prolonged contact of the paper with the drum unit could cause a fire.**
- **DO NOT use a vacuum cleaner to clean up scattered toner. Doing this might cause the toner dust to ignite inside the vacuum cleaner, potentially starting a fire. Please carefully clean the toner dust with a dry, lint-free soft cloth and dispose of it according to local regulations.**
- **DO NOT use this product in the vicinity of a gas leak or combustible dust.**

# Other Information

## HOT SURFACE

- After you have just used the product, some internal parts will be extremely hot. To prevent injury, **DO NOT** touch the shaded parts shown in the illustration, when you open the top or back cover (back output tray).

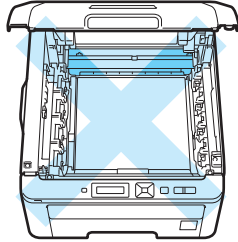

Inside the product  
(Top View)

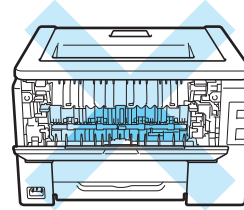

Inside the product  
(Back View)

- **DO NOT** touch the shaded parts shown in the illustration. These rollers may be rotating at high speed and can pinch or entrap your hand.

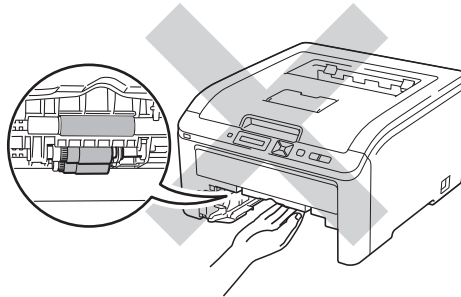

## IMPORTANT

**DO NOT** remove or damage the caution labels located on or in the product.



## Note

*Lightning and power surges can damage this product. We recommend that you use a quality surge protection device on the AC power line and any Ethernet (RJ-45) cable plugged into the product.*

## Important safety instructions

- 1 Read all of these instructions.
- 2 Save these instructions for later reference.
- 3 Follow all warnings and instructions marked on the product.
- 4 Be careful not to inhale toner.
- 5 DO NOT place anything in front of the product that will block printed pages.  
DO NOT place anything in the path of printed pages.
- 6 Wait until pages have exited the product before picking them up.
- 7 DO NOT attempt to service this product yourself because opening or removing covers may expose you to dangerous voltage points and other risks and may void your warranty. Refer all servicing to a Brother Authorized Service Center. For the location of your nearest Brother Authorized Service Center, please call:  
**In USA:** 1-877-BROTHER (1-877-276-8437)  
**In Canada:** 1-877-BROTHER
- 8 Unplug this product from the AC power outlet and refer all servicing to Brother Authorized Service Personnel under the following conditions:
  - When the power cord is damaged or frayed. (DO NOT touch the damaged/frayed part while unplugging your product.)
  - If liquid has been spilled into the product.
  - If the product has been exposed to rain or water.
  - If the product does not operate normally when the operating instructions are followed.  
Adjust only those controls that are covered by the operating instructions. Improper adjustment of other controls may result in damage and will often require extensive work by a qualified technician to restore the product to normal operation.
  - If the product has been dropped or the cabinet has been damaged.
  - If the product exhibits a distinct change in performance, indicating a need for service.
- 9 For Material Safety Data Sheet for applicable accessories, visit <http://www.brother.com/>. (USA only)

## Regulation

### Federal Communications Commission (FCC) Declaration of Conformity (USA only)

Responsible Party: Brother International Corporation  
100 Somerset Corporate Boulevard  
Bridgewater, NJ 08807-0911 USA  
TEL: (908) 704-1700

declares, that the products

Product Name:HL-3045CN / HL-3075CW

Model Number:HL-30

comply with Part 15 of the FCC Rules. Operation is subject to the following two conditions: (1) This device may not cause harmful interference, and (2) this device must accept any interference received, including interference that may cause undesired operation.

This equipment has been tested and found to comply with the limits for a Class B digital device, pursuant to Part 15 of the FCC Rules. These limits are designed to provide reasonable protection against harmful interference in a residential installation. This equipment generates, uses, and can radiate radio frequency energy and, if not installed and used in accordance with the instructions, may cause harmful interference to radio communications. However, there is no guarantee that interference will not occur in a particular installation. If this equipment does cause harmful interference to radio or television reception, which can be determined by turning the equipment off and on, the user is encouraged to try to correct the interference by one or more of the following measures:

- Reorient or relocate the receiving antenna.
- Increase the separation between the equipment and receiver.
- Connect the equipment into an outlet on a circuit different from that to which the receiver is connected.
- Call the dealer or an experienced radio/TV technician for help.
- (Wireless network models only)

This transmitter must not be co-located or operated in conjunction with any other antenna or transmitter.

#### ! IMPORTANT

- **Changes or modifications not expressly approved by Brother Industries, Ltd. could void the user's authority to operate the equipment.**
- **A shielded interface cable should be used to ensure compliance with the limits for a Class B digital device.**

### Industry Canada Compliance Statement (Canada only)

This Class B digital apparatus complies with Canadian ICES-003.

Cet appareil numérique de la classe B est conforme à la norme NMB-003 du Canada.

Operation is subject to the following two conditions: (1) this device may not cause interference, and (2) this device must accept any interference, including interference that may cause undesired operation of this device.

L'utilisation de ce dispositif est autorisée seulement aux conditions suivantes:

(1) il ne doit pas produire de brouillage et (2) l'utilisateur du dispositif doit être prêt à accepter tout brouillage radioélectrique reçu, même si ce brouillage est susceptible de compromettre le fonctionnement du dispositif.

### Disconnect device

This product must be installed near an AC power outlet that is easily accessible. In case of emergencies, you must disconnect the power cord from the AC power outlet to shut off power completely.

---

## LAN connection (Network models only)

### CAUTION

DO NOT connect this product to a LAN connection that is subject to over-voltages.

---

## International ENERGY STAR® Qualification Statement

The purpose of the International ENERGY STAR® Program is to promote the development and popularization of energy-efficient office equipment.

As an ENERGY STAR® Partner, Brother Industries, Ltd. has determined that this product meets the ENERGY STAR® specifications for energy efficiency.



## Shipment of the printer

If for any reason you must ship your printer, carefully package the printer to avoid any damage during transit. We recommend that you save and use the original packaging. The printer should also be adequately insured with the carrier.

### CAUTION

When shipping the printer, the DRUM UNIT, TONER CARTRIDGE assemblies and WASTE TONER BOX must be removed from the printer and put in a plastic bag. Failure to remove these items and put them in a plastic bag before shipping may cause severe damage to the printer and may VOID THE WARRANTY.

## Repacking Instructions

Make sure that you have the following parts for repacking.

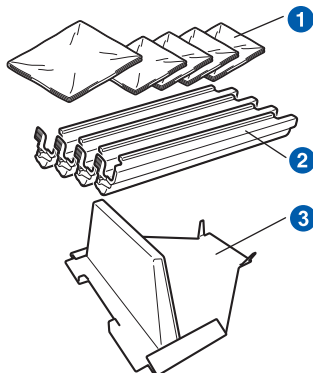

- 1 Plastic bags – to be supplied by you, the user; one for the waste toner box, and one each for the four drum and toner cartridge assemblies
- 2 Protective covers that the original drum and toner cartridge assembly came with
- 3 Packing material for locking the belt unit

### WARNING

This printer is heavy and weights approximately 41.9 lb. (19.0 kg). To prevent injuries use at least two people to lift the printer. Be careful not to pinch your fingers when you put the printer back down.

- a** Turn off the printer power switch, and then unplug the AC power cord.

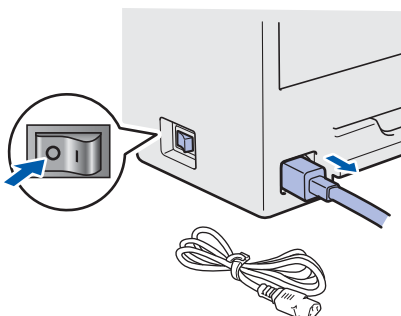

- b** Fully open the top cover and take out all the drum unit and toner cartridge assemblies.

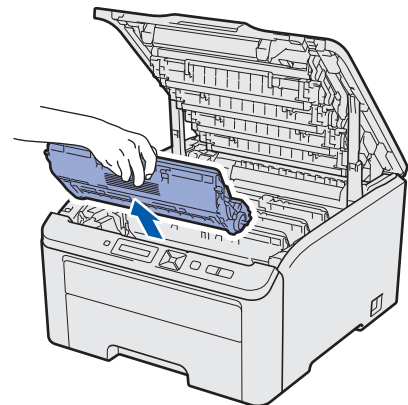

Attach the protective cover to each of the drum unit and toner cartridge assemblies.

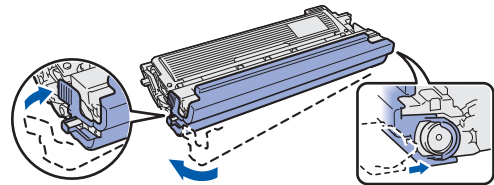

Put each assembly into a plastic bag and completely seal each bag.

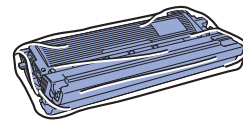

- c** Remove the belt unit by holding the green handle and lifting the belt unit up and out of the printer.

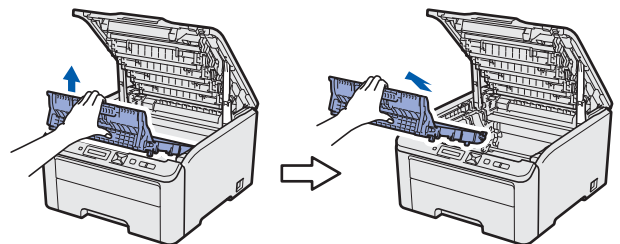

- d** Remove the waste toner box from the printer, and then put it in a plastic bag and seal the bag completely.

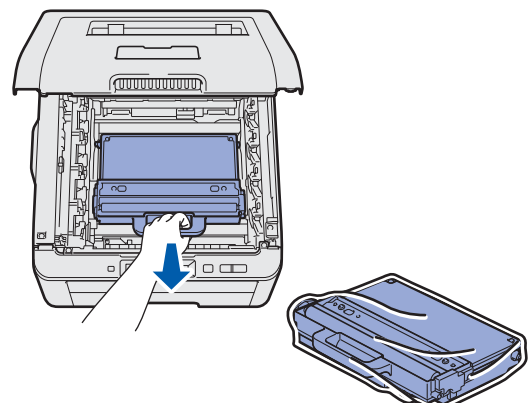



# Other Information

- e** Reinstall the belt unit back in the printer.

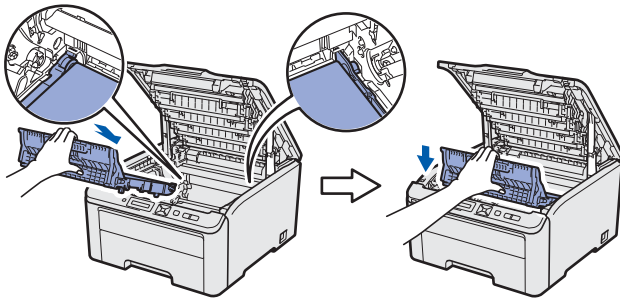

- f** Reinstall the original packing material into the printer.

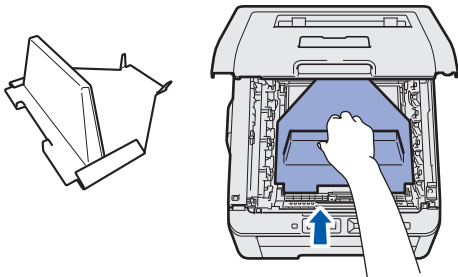

- g** Close the top cover of the printer.

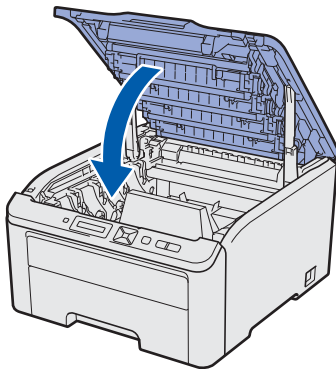

- h** Put the waste toner box in the Styrofoam piece.

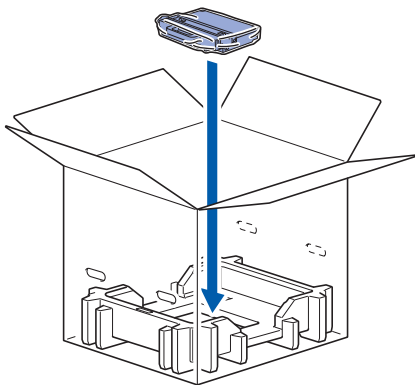

- i** Using two people, place the printer into the plastic bag.

- j** Put the printer and the Styrofoam pieces into the carton. Match the front side of the printer to the "FRONT" mark on the Styrofoam pieces. Put the Styrofoam piece for the drum unit and toner cartridge assemblies on the top of the printer.

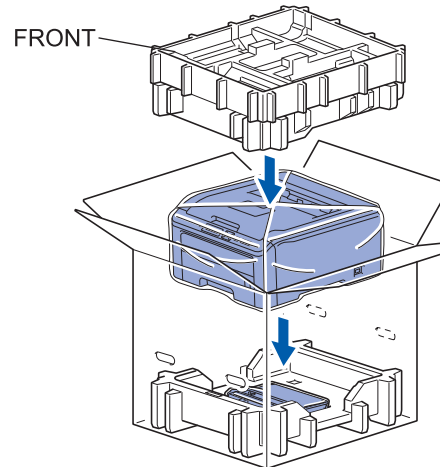

- k** Put the power cord, drum unit and toner cartridge assemblies into the Styrofoam piece as shown in the illustration.

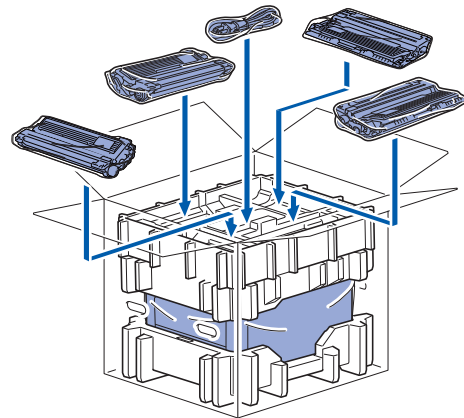

- l** Put the two carton trays on the top.

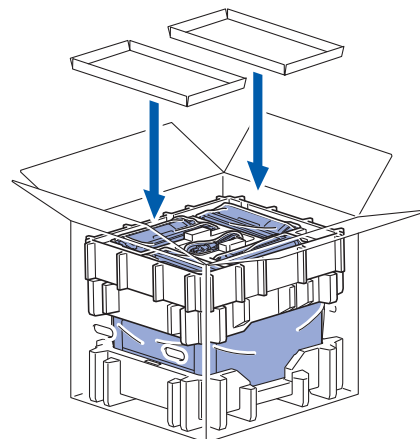

- m** Close the carton and tape it shut.

## Control panel

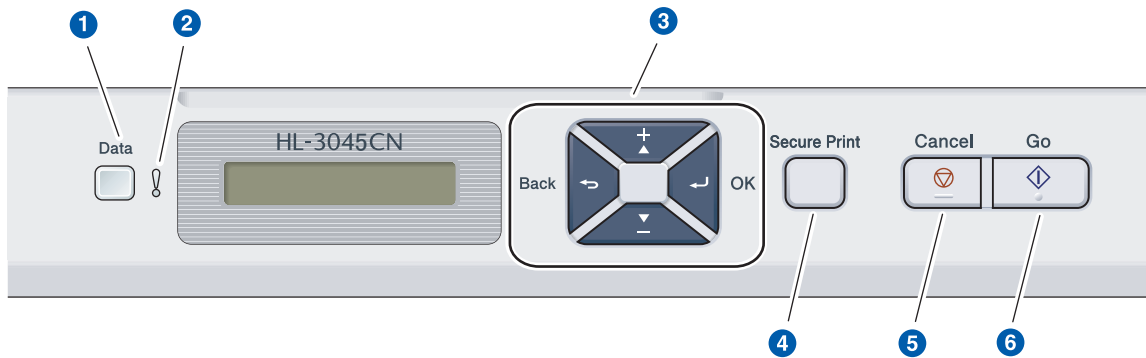

### 1 Data LED

On: Data is in the printer memory.  
Blinking: Receiving / processing data.  
Off: No remaining data in the memory.

### 2 Error LED

Blinking: There is a problem with the printer.  
(Refer to the *User's Guide* for trouble shooting.)  
Off: There is no problem with the printer.

### 3 Menu buttons

**+**: Scroll forward through menus and the available options.  
**-**: Scroll backward through menus and the available options.  
**OK**: Choose the control panel menu. Set the chosen menu and settings.  
**Back**: Go back one level in the menu structure.

### 4 Secure Print button

Prints data saved in memory when you enter your four-digit password.

### 5 Cancel button

Stops and Cancels the printer operation in progress.

### 6 Go button

Pause and continue printing / Error recovery / Reprint



For the details of the control panel, see chapter 3 of the User's Guide on the CD-ROM.

# Options and Consumables

## Option

The printer has the following optional accessory. You can expand the capabilities of the printer by adding this item. For more information about the compatible SO-DIMM Memory, visit us at <http://solutions.brother.com/>.

 For installing the SO-DIMM Memory, see Chapter 4 of the User's Guide on the CD-ROM.

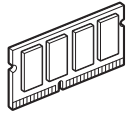
SO-DIMM Memory
You can expand the memory by installing a (144-pin SO-DIMM) memory module.

## Consumables

Please prepare a new consumable item for replacement when the following messages appear on the LCD.

Toner Low

Drums End Soon

Belt End Soon

WT Box End Soon

When the time comes to replace consumable items, the following messages will appear on the LCD.

Replace Toner

Replace Drums

Replace Belt

Replace WT Box

When the time comes to replace consumable items, an error will be indicated by the LCD on the control panel. For more information about the consumables for your printer, visit us at <http://www.brother.com/original/> or contact your local Brother reseller.

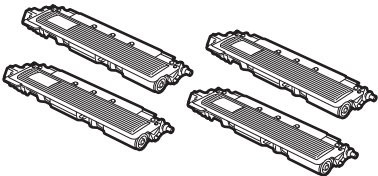
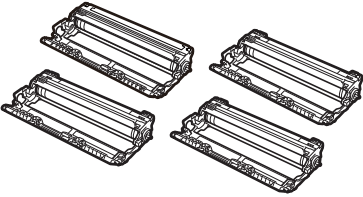
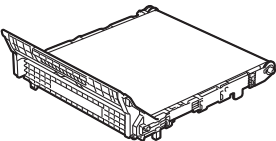
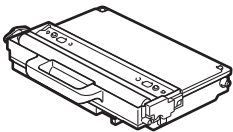
Toner cartridges	Drum units
	
Belt Unit (BU-200CL)	Waste Toner Box (WT-200CL)
	

 For replacing the consumable items, see Chapter 5 of the User's Guide on the CD-ROM.

## **Trademarks**

The Brother logo is a registered trademark of Brother Industries, Ltd.

Brother is a registered trademark of Brother Industries, Ltd.

Microsoft, Windows, Windows Server, Outlook and Internet Explorer are registered trademarks of Microsoft Corporation in the United States and/or other countries.

Windows Vista is either a registered trademark or a trademark of Microsoft Corporation in the United States and other countries.

Apple, Macintosh, Safari and TrueType are trademarks of Apple Inc., registered in the United States and other countries.

**Any trade names and product names of companies appearing on Brother products, related documents and any other materials are all trademarks or registered trademarks of those respective companies.**

## **Compilation and Publication**

Under the supervision of Brother Industries, Ltd., this manual has been compiled and published, covering the latest product descriptions and specifications.

The contents of this manual and the specifications of this product are subject to change without notice.

Brother reserves the right to make changes without notice in the specifications and materials contained herein and shall not be responsible for any damages (including consequential) caused by reliance on the materials presented, including but not limited to typographical and other errors relating to the publication.

This product is designed for use in a professional environment.

## **Copyright and License**

© 2011 Brother Industries, Ltd.

© 1983-1998 PACIFIC SOFTWARES INC.

This product includes the "KASAGO TCP/IP" software developed by ELMIC WESCOM, INC.

© 2011 Devicescape Software, Inc.

This product includes RSA BSAFE Cryptographic software from RSA Security Inc.

Portions Copyright for ICC profiles 2003 by European Color Initiative, [www.eci.org](http://www.eci.org). ALL RIGHTS RESERVED.