

# MFC-5100C Quick Setup Guide

brother  
version C

## THANK YOU!

CONGRATULATIONS ON PURCHASING THE ULTIMATE BROTHER MACHINE. WE ARE SURE YOU WILL BE THRILLED WITH THE CONVENIENT WAY YOUR NEW MACHINE PERFORMS SO MANY TASKS WITH DAZZLING RESULTS!

Follow these simple instructions in numerical order.

For more details, press **Reports**, (1) on your machine or see your Owner's Manual.

If you cannot solve a problem:

Refer to **Frequently Asked Questions (FAQs)** on Brother World Wide Web;

URL: <http://solutions.brother.com>

Call Brother Customer Service at;

USA: 1-800-284-4329 (9 AM - 5 PM EST)  
1-800-284-3238 (TTY service for the hearing impaired)

In Canada: 1-877-BROTHER (8 AM - 8 PM EST)  
1-514-685-6464 (in Montreal)

## 1 Packing List

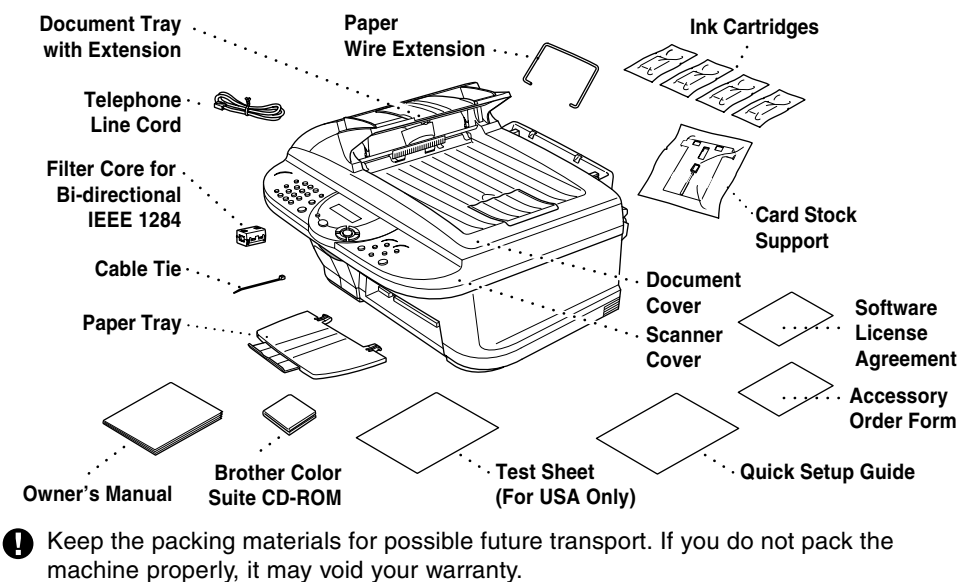

## 2 Remove the Protective Yellow Bar

A. Open the Scanner Cover of the MFC by pulling the scanner cover release lever toward you and lifting the scanner cover.

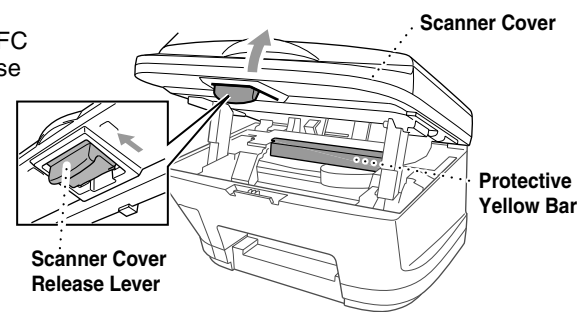

B. Pull the protective yellow bar out of the machine.

❗ Do not throw away the protective yellow bar. You will need it for future transportation.

C. Close the Scanner Cover.

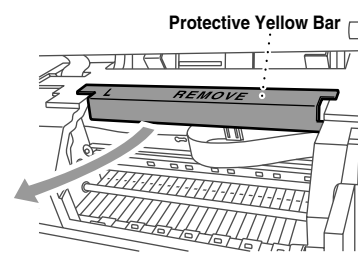

## 3 Install phone Line and Power Cord

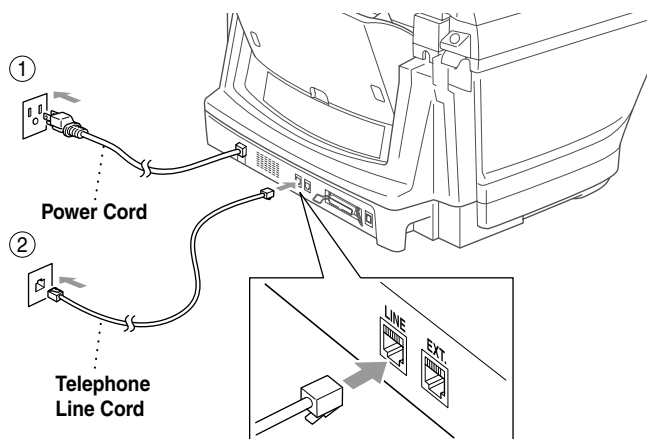

❗ Do NOT connect the Parallel or USB cable.

## 4 If you are sharing one phone line with an external telephone, connect it as shown below.

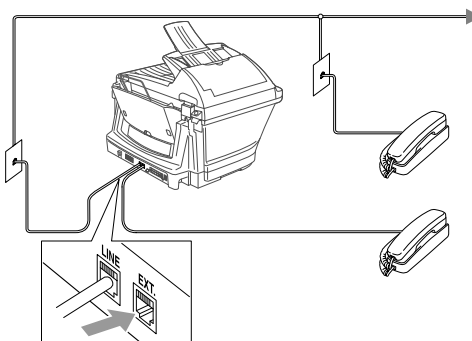

Must select EXT.TEL/TAD mode. (See Step 9.)

## If you are sharing one phone line with an external telephone answering device, connect it now to the external jack.

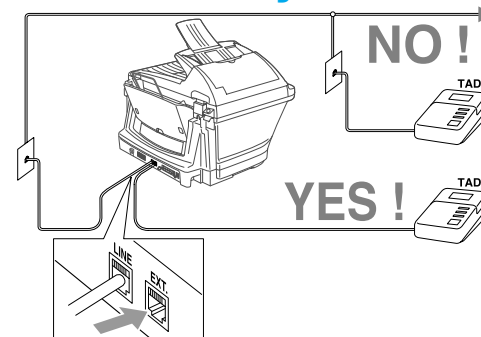

Note: Please select "TAD" on your machine if you have an external answering machine. (For more details, see page 2-13 to 2-15 in Owner's Manual that is included on the CD-ROM.)

## 5 Attach Trays and Extensions

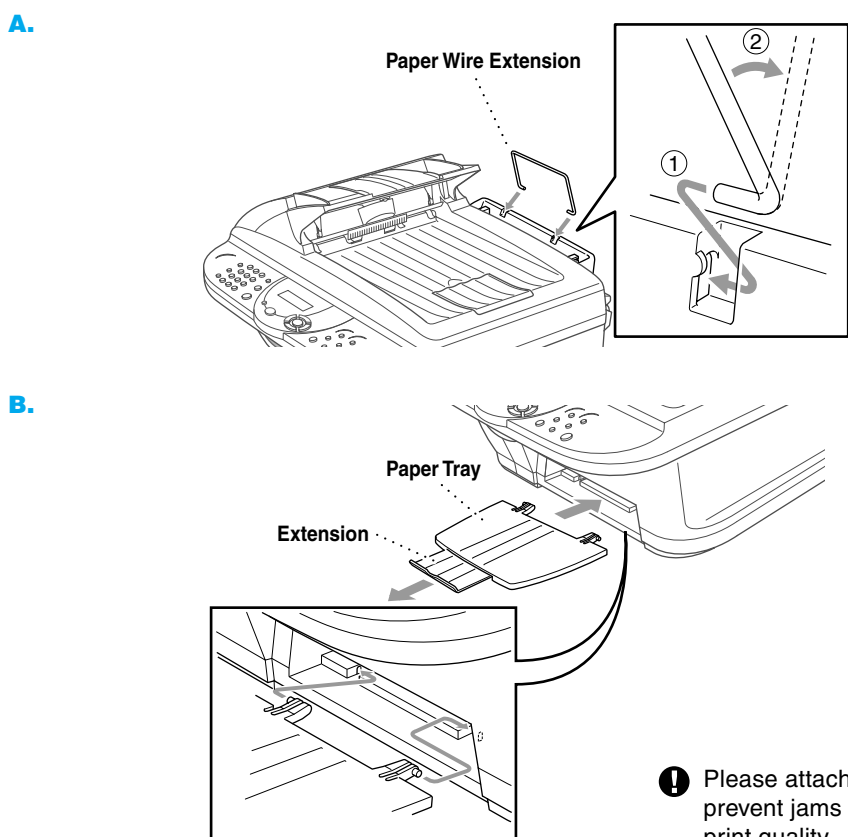

## 6 Load Paper

A. Fan the paper well. Gently insert the paper. Make sure the print side is toward you and the paper level is stacked below the paper guide line.

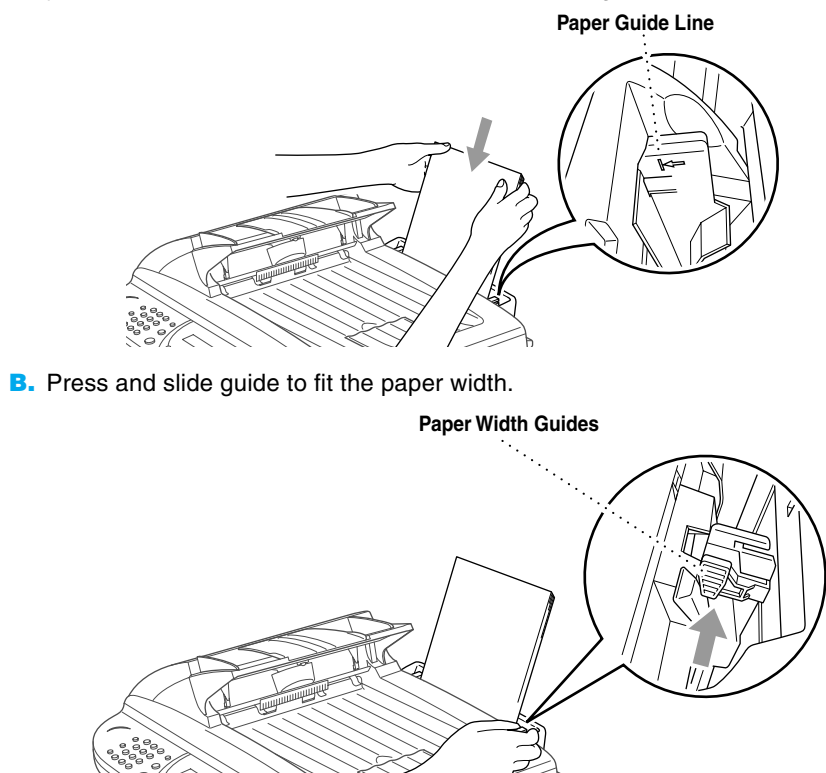

# 7 Install the Ink Cartridges

**A.** Check that the power is turned on (by plugging in the power cord). The LCD shows:

CHECK CARTRIDGE

**B.** Open the Scanner Cover of the MFC by pulling the scanner cover release lever toward you and lifting the scanner cover. After a few seconds, the print head will move left to its replacement position.

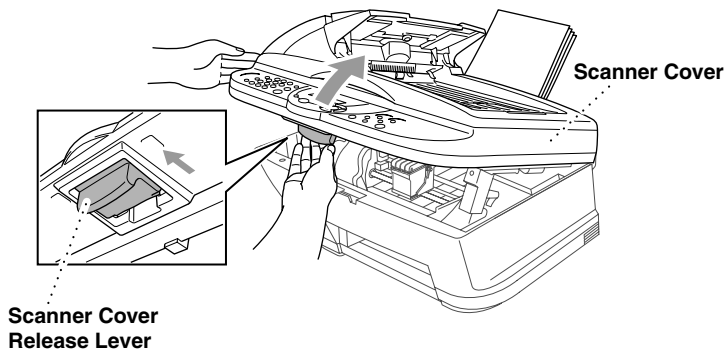

- The bottom of the white shipping cover is wet with ink that will cause stains, so wipe it clean before you place it down.
- Do not throw away the white shipping cover. You will need it for future transportation.

**C.** Remove the protective blue tape over the colored ink cartridge covers.

**D.** Push the four colored ink cartridge covers one at a time so they pop up. Then remove the white shipping cover by pulling it toward you and then lifting it up and out.

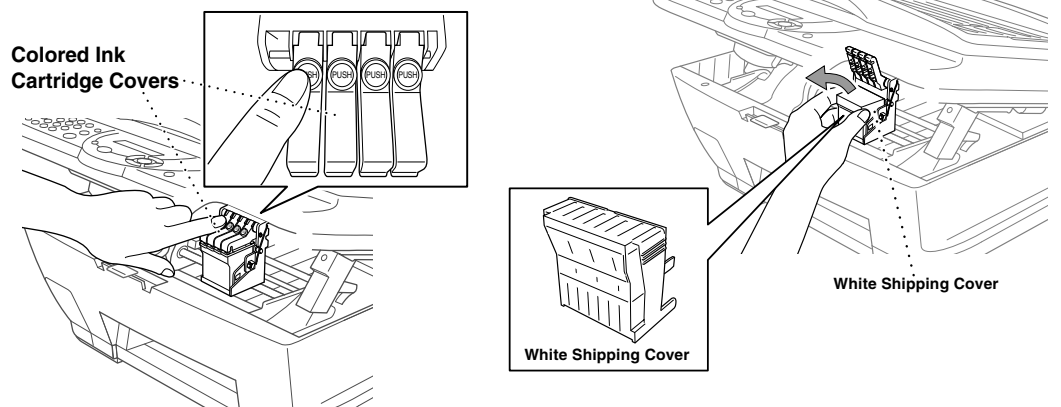

## WARNING

If ink gets in your eyes, irrigate them with water immediately and if irritation occurs, consult a doctor.

**I.** We recommend that you install the ink cartridges from left to right in this order: Black, Cyan, Yellow, Magenta.

**E.** Open the Black ink cartridge bag and take out the ink cartridge.

**F.** Carefully remove the sealing tape from the bottom of the ink cartridge. You should peel the tape in the direction away from you.

### Important

To prevent spilling ink and staining your hands and clothing, peel the sealing tape gently and slowly. Do not touch the ink opening on the cartridge or the removed tape.

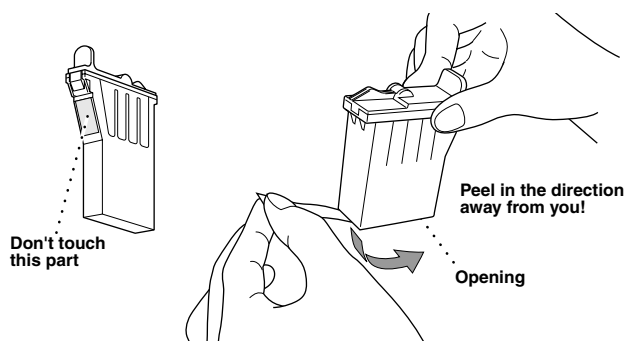

**G.** Each color has its own correct position. Match the colors of the ink cartridge covers, First, gently insert the Black ink cartridge, and then press the cover down until it clicks.

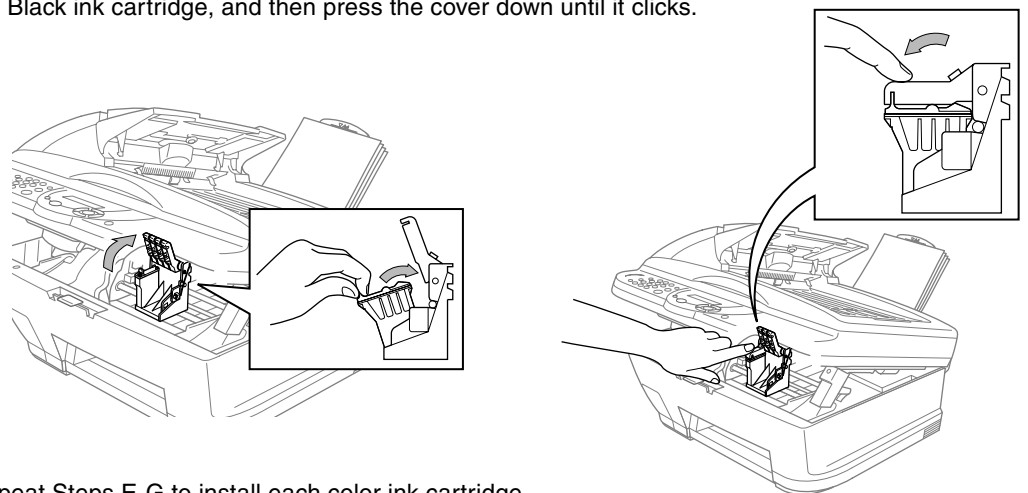

**H.** Repeat Steps E-G to install each color ink cartridge.

**I.** After installing all ink cartridges, close the Scanner Cover until it click into place. Your MFC will enter a "head cleaning" cycle for approximately **four minutes**.

**J.** Make sure the paper is loaded in the multi-purpose sheet feeder. The LCD shows **CLEANING**. After the cleaning cycle is finished, the LCD shows **PRESS FAX START**.

**J.** Press **Black Fax Start** and go to Step 8 "Check Color Block Quality and Alignment".

# 8 Check Color Block Quality and Alignment

The MFC starts printing the PRINT QUALITY CHECK SHEET (only during initial ink cartridge installation).

Check the sheet to see if the quality and alignment are OK by following STEPs A and B.

## STEP A: Color Block Quality Check

The LCD shows:

IS STEP "A" OK?  
1. YES 2. NO

Check the quality of the four color blocks printed on the sheet. (BLACK/CYAN/YELLOW/MAGENTA).

If the quality is OK for all colors, press **1** (YES) to go to **STEP B**

—OR—

If white horizontal lines appear in some color blocks below, press

**2** (NO).

**OK**

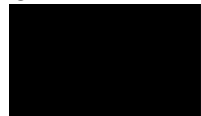

**Poor**



The LCD asks you if the print quality is OK for each color.

BLACK OK?  
1. YES 2. NO

Press **2** (NO) for any color with a problem.

The LCD shows:

START CLEANING?  
1. YES 2. NO

Press **1** (YES), then MFC starts cleaning the colors.

After cleaning is finished, press **Black Fax Start**. The MFC starts printing PRINT QUALITY CHECK SHEET again and goes back to the first step of **STEP A**.

## STEP B: Alignment Check

The LCD shows:

IS STEP "B" OK?  
1. YES 2. NO

Check the 600DPI and 1200DPI test print to see if No.5 most closely matches the **OK** sample (0).

If No.5 is the best match, enter **1** (YES)—OR—

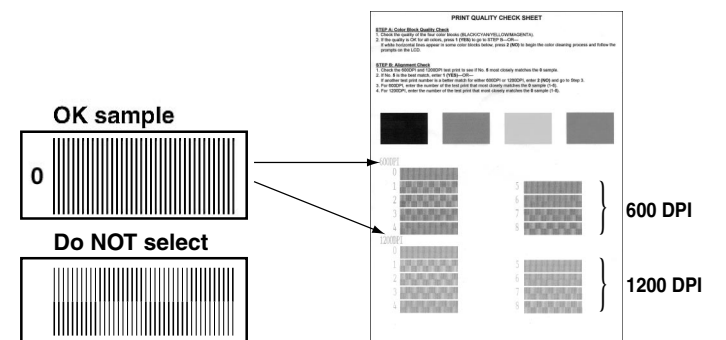

If another test print number is a better match for either 600DPI or 1200DPI, enter **2** (NO) to select it.

For 600DPI, enter the number of the test print that most closely matches the 0 sample (1-8).

600DPI ADJUST  
SELECT BEST #

For 1200DPI, enter the number of the test print that most closely matches the 0 sample (1-8).

1200DPI ADJUST  
SELECT BEST #

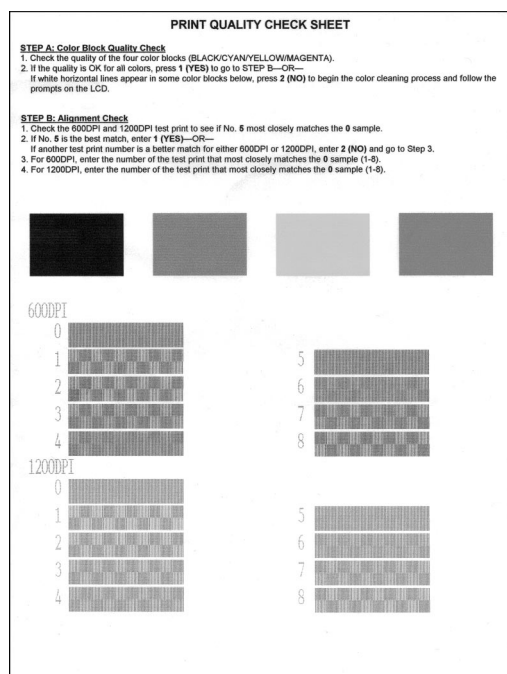



# MFC-5100C Control Panel

## Navigation Keys

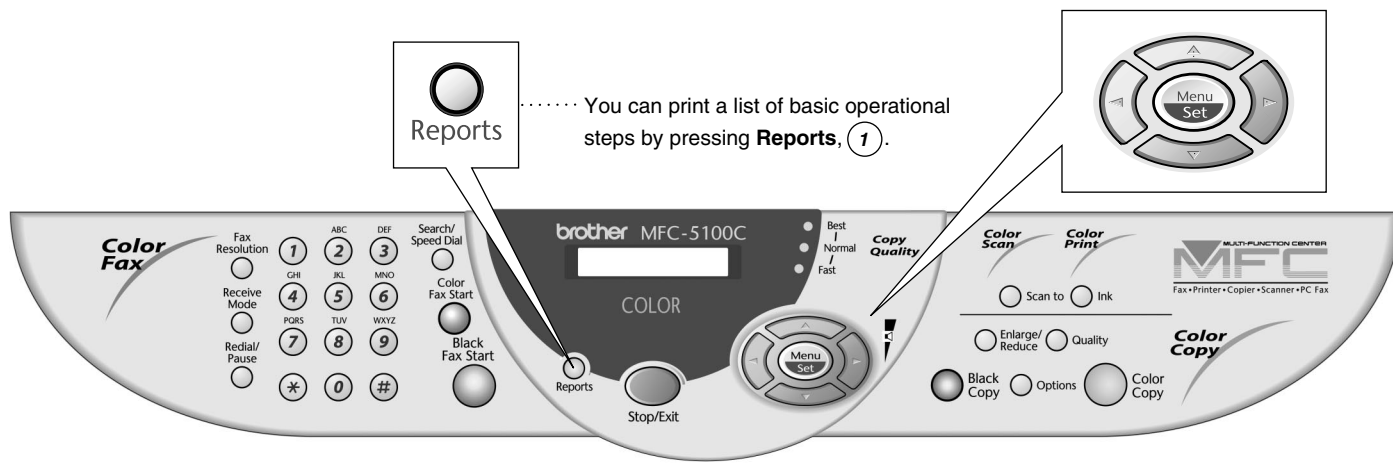

- \* Access the Menu
- \* Go to next menu level
- \* Accept an option
- \* Scroll through the current menu level
- \* Back to previous menu level
- \* Forward to next menu level
- \* Exit the Menu

## 9 Select a Receive Mode

Choose the mode that best suits your needs by pressing **Receive Mode** repeatedly until the LCD shows the setting you want to use.

**FAX ONLY**

The MFC automatically answers every call as a fax.

**EXT. TEL/TAD**

An external TAD (telephone answering device) answers every call and stores voice messages in memory; fax messages are printed.  
An external telephone operates as if in MANUAL mode.

**MANUAL**

You control the phone line and must answer every call yourself.

For more details, see page 4-1 in Owner's Manual or page 5-1 in Owner's Manual that is included on the CD-ROM.

## 10 Set Date and Time

Your MFC displays the date and time, and prints it on every fax you send.

A. Press **Menu/Set**, **1**, **3**.

3. DATE/TIME  
YEAR:XX

B. Enter the last two digits of the year and press **Menu/Set**.

MONTH:XX

C. Enter two digits for the month and press **Menu/Set**.

DAY:XX

D. Enter two digits for the day and press **Menu/Set**.

TIME:XX:XX

E. Enter the time in 24-hour format and press **Menu/Set**.

F. Press **Stop/Exit**.

Note: If you can't step forward, press **Stop/Exit** and repeat from step A.

## 11 Set Station ID

You should store your name and fax number to be printed on all fax pages you send.

A. Press **Menu/Set**, **1**, **4**.

4. STATION ID  
FAX:

B. Enter your fax number, then press **Menu/Set**.

NAME:

C. Enter your name using the dial pad and the chart below, then press **Menu/Set**. Use the right arrow to create spaces.

D. Press **Stop/Exit**.

For more details, see pages 3-2 to 3-3 in Owner's Manual or 4-2 to 4-3 in Owner's Manual that is included on the CD-ROM.

Key	once	twice	three times	four times	five times
2	A	B	C	2	A
3	D	E	F	3	D
4	G	H	I	4	G
5	J	K	L	5	J
6	M	N	O	6	M
7	P	Q	R	7	P
8	T	U	V	8	T
9	W	X	Y	9	W

Note: If you can't step forward, press **Stop/Exit** and repeat from step A.

## 12 For the USA, complete the Warranty Registration and Test Sheet ...and fax it to Brother at: 1-877-268-9575

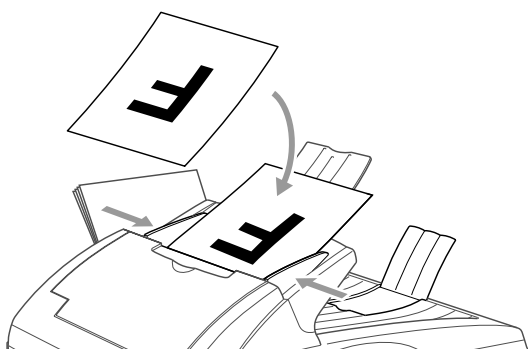

- A. Fill out the Test Sheet.
- B. Place the sheet face up in the ADF.
- C. Enter the fax number: 1-877-268-9575.
- D. Press **Black Fax Start**.



## For Improving Print Quality

If horizontal streaks appear like this, clean the print head.  
(See *Cleaning the Print Head* in Owner's Manual or visit us at <http://solutions.brother.com>)



If characters and lines are stacked like this, check alignment.  
(See *Print Quality Check* in Owner's Manual or visit us at <http://solutions.brother.com>)

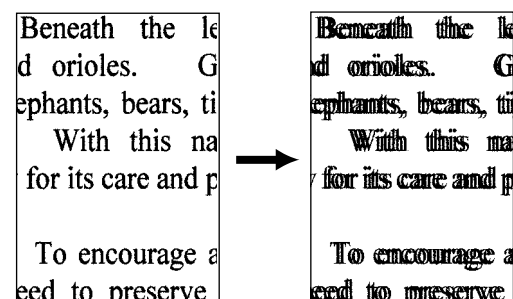

# Setting Up the MFC and PC to Work Together

## Before You Begin

- You must set up the hardware and install the driver before you can use your MFC as a printer and scanner with your applications.
- Please see the README.WRI file in the root directory of the CD-ROM for last-minute important installation and troubleshooting information.
- Please purchase the appropriate interface cable you intend to use (Parallel or USB).
- If you have any problem for installation, visit us at: <http://solutions.brother.com>

**!** Use only a shielded parallel interface cable that is IEEE 1284-compliant and/or a USB cable that is no longer than 6 feet long (1.8 meters).

Follow the instructions in this guide for your operating system and interface.

## For Windows® 95/98/98SE/Me/2000 Users

**MAKE SURE THAT YOU FOLLOWED THE SET-UP INSTRUCTIONS ON PAGE 1 TO 3 BEFORE CONTINUING**

**Step 1.** Unplug the MFC from the AC outlet and disconnect your MFC from your computer if you already connected an interface cable.

**Step 2.** Turn on your computer.

For Windows® 2000 Professional, you must be logged on as the Administrator.

**Step 3.**  Insert the CD-ROM into the CD-ROM drive. If the model name screen appears, click on your model name. The CD-ROM main menu will appear. (If this window does not appear, use Windows® Explorer to run the setup.exe program from the root directory of the Brother CD-ROM.)



1. Click Install Software.

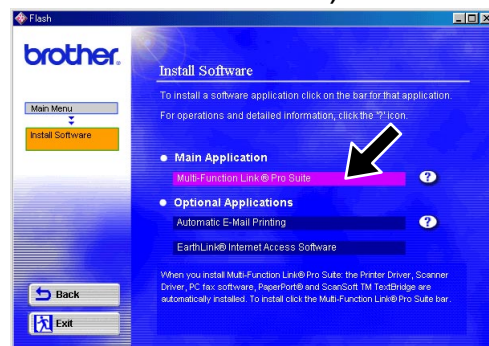

2. Click Multi-Function Link® Pro Suite in Main Application. \*1

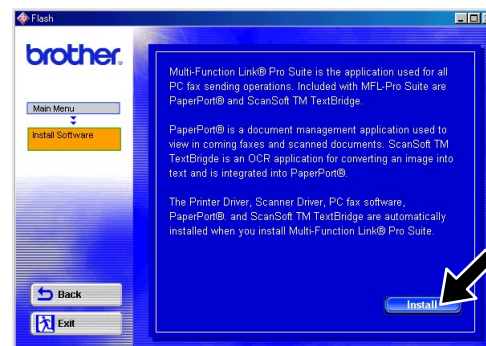

3. Click Install.

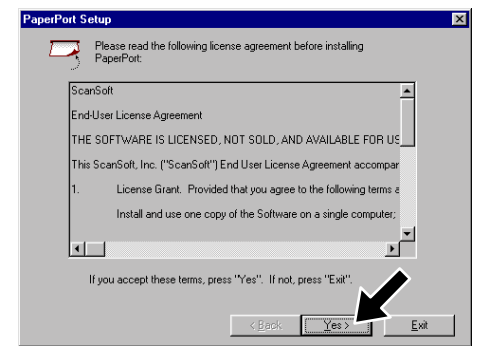

4. The InstallShield Wizard Setup window will appear briefly, followed by the PaperPort® Setup window. Click Yes.

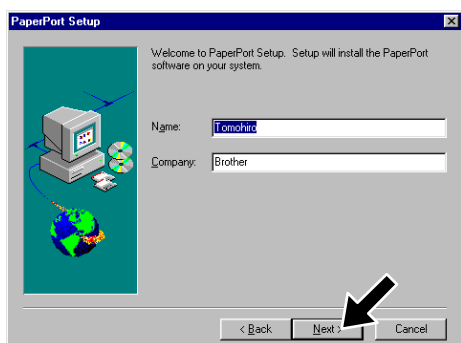

5. When the PaperPort® Setup window displays your Name and Company, either change or accept them, and then click Next.

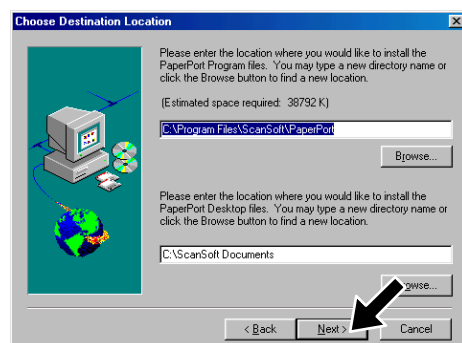

6. When the Choose Destination Location window displays the path where the PaperPort® files will be installed, either change or accept, and then click Next.

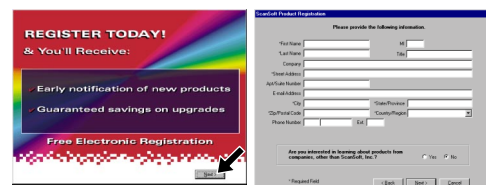

7. When Register Today screen appears, click Next. This is registration for PaperPort®. Follow the instructions.

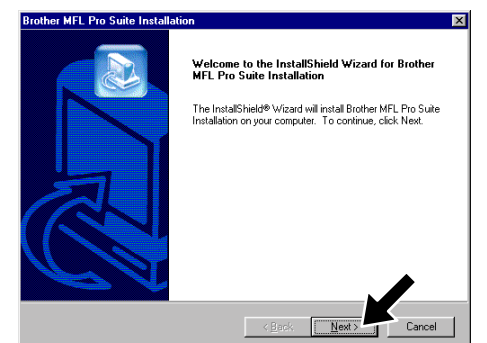

8. When the Brother MFL Pro Suite Installation window appears, click Next to begin installing the Multi-Function Link® Pro Suite. \*2

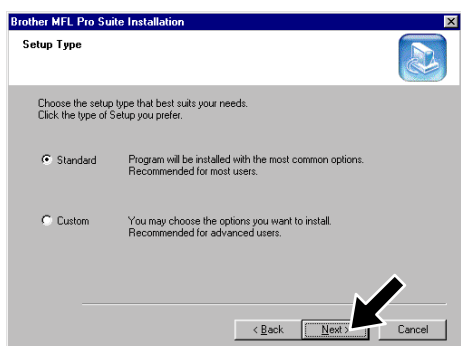

9. When the Setup Type window appears, select Standard, and then click Next. The application files will be copied to your computer.

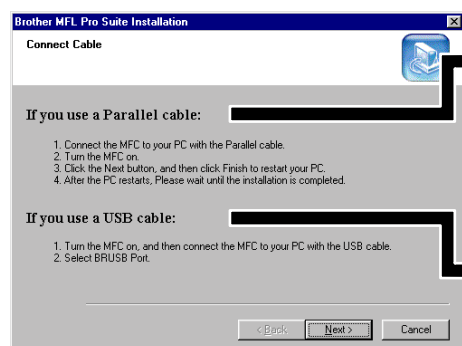

10. The Connect Cable window will appear.

For Parallel

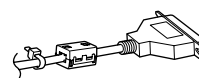

For USB

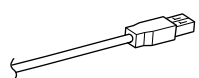

**Please see NEXT PAGE**

\*1 Multi-Function Link® Pro Suite includes Printer Driver, Scanner Driver, ScanSoft™ PaperPort®, ScanSoft™ Text Bridge®, PC-FAX software, Remote Setup and True Type fonts. PaperPort® is a document management application for viewing scanned documents. ScanSoft™ TextBridge®, which is integrated into PaperPort®, is an OCR application that converts an image into text and inserts it into your default word processor.

\*2 If an error message appears during the installation process, or you have previously installed MFL Pro Suite, you will first have to uninstall it. From the Start menu, select Programs, Brother, Brother MFL Pro Suite, Uninstall, and then follow the instructions on the screen.

\*3 Even if you select NO, later you will be able to launch the Brother Control Center to use the Scan to key. See AutoLoad the Brother Control Center, Chapter 13 in the On-Line Documentation (Owner's Manual) on the CD-ROM.

## Step 4. Connect the MFC to your PC with Parallel Cable.

- Connect the Filter Core and Cable Tie to the parallel interface cable.
- Connect the parallel interface cable to the parallel interface port of the MFC and secure the wire clips.
- Connect the interface cable to the printer port of the computer and secure it with the two screws. For the location of your computer's parallel printer port, see the User's Guide for your computer.

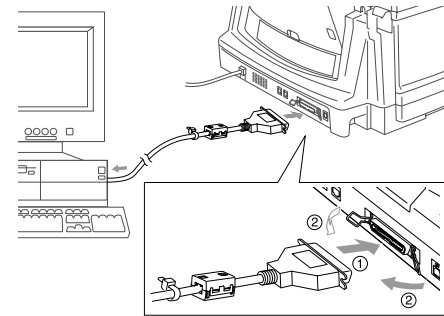

## Step 5. Turn on the MFC by plugging in the power cord.

## Step 6. The installation of the Brother driver will automatically start. Follow the instructions on the screen.

( For Windows® 95/98/98SE/Me Users )

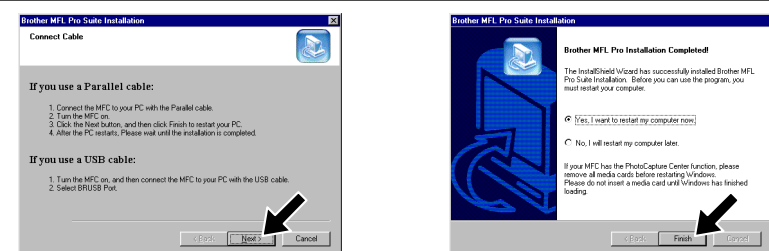

- In the Connect Cable window, click **Next**.
- When the above screen appears, click **Finish** and wait as the PC restarts Windows® and continues the installation.

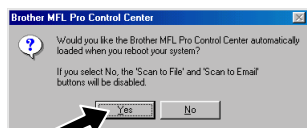

- Click **Yes** to have the Control Center loaded each time Windows® is started. The Control Center will appear as an icon in the task tray. If you click **No** the Scan keys on the MFC will be disabled. \*3

The Brother PC fax, Printer and Scanner drivers have been installed and the installation is now complete.

( For Windows® 2000 Professional User )

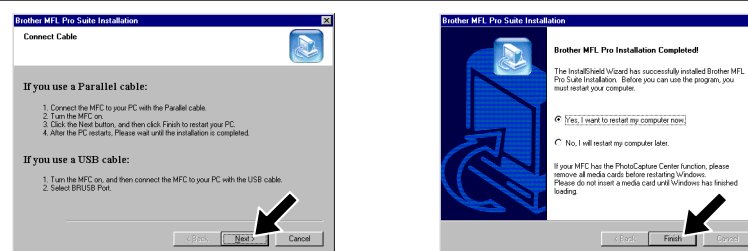

- In the Connect Cable window, click **Next**.
- When the above screen appears, Click **Finish** and wait as the PC restarts Windows® and continues the installation.

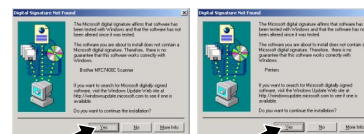

- When the **Digital Signature Not Found** dialog boxes appear, click **Yes** to install the driver.

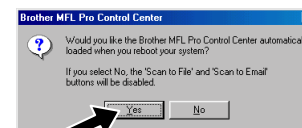

- Click **Yes** to have the Control Center loaded each time Windows® is started. The Control Center will appear as an icon in the task tray. If you click **No** the Scan to key on the MFC will be disabled. \*3

The Brother PC fax, Printer and Scanner drivers have been installed and the installation is now complete.

## Step 4. Turn on the MFC by plugging in the power cord.

## Step 5. Connect the MFC to your PC with the USB cable. (It will take a few seconds for the installation screen to appear.)

## Step 6. The installation of the Brother driver will automatically start. Follow the instructions on the screen.

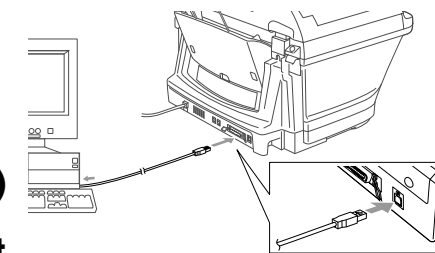

( For Windows® 98/98SE/Me Users )

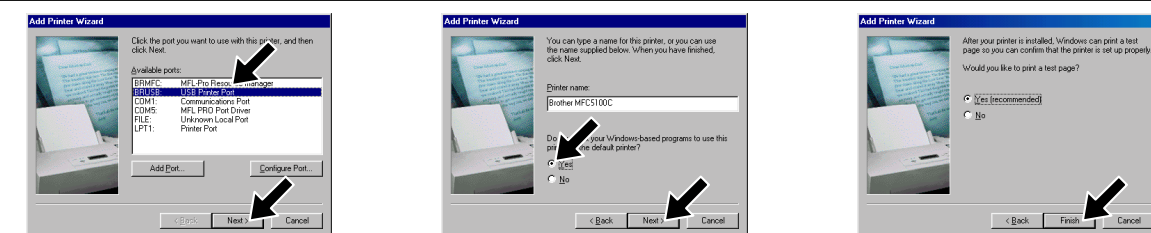

- In the Add Printer Wizard window, select **BRUSB: USB Printer Port**, and then click **Next**.
- Accept the default Printer name by selecting **Yes**, and then click **Next**.
- Select **Yes (recommended)**, and then click **Finish**. A test page will be printed so you can check the print quality.

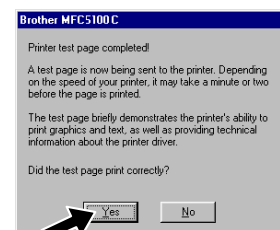

- If the test page is printed correctly, click **Yes**. If you click **No**, follow the prompts on the screen to correct the problem.

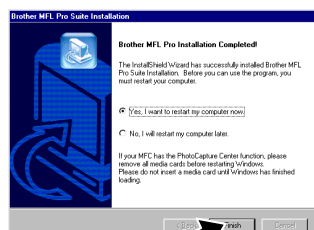

- Select **Yes** to restart your computer, and then click **Finish**.

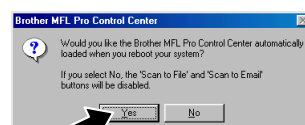

- Click **Yes** to have the Control Center loaded each time Windows® is started. The Control Center will appear as an icon in the task tray. If you click **No** the Scan to key on the MFC will be disabled. \*3

The Brother PC fax, Printer and Scanner drivers have been installed and the installation is now complete.

( For Windows® 2000 Users )

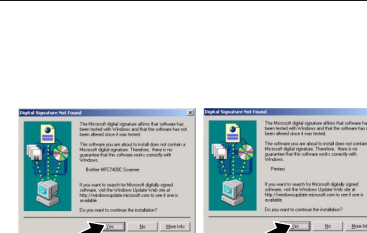

- When the **Digital Signature Not Found** dialog boxes appear, click **Yes** to install the driver.

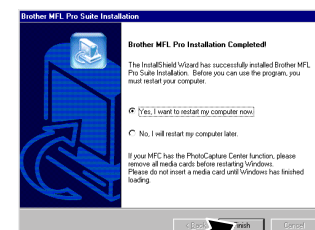

- Select **Finish** to restart your computer.

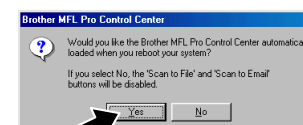

- Click **Yes** to have the Control Center loaded each time Windows® is started. The Control Center will appear as an icon in the task tray. If you click **No** the Scan to key on the MFC will be disabled. \*3

The Brother PC fax, Printer and Scanner drivers have been installed and the installation is now complete.

# For Windows NT® Workstation Version 4.0 Users

**MAKE SURE THAT YOU FOLLOWED THE SET-UP INSTRUCTIONS ON PAGE 1 TO 3 BEFORE CONTINUING**

**Step 1.** Check that your computer is turned on.

You must be logged on as the Administrator.

**Step 2.** Connect the MFC to your PC with the Parallel Cable.

- A. Connect the Filter Core and Cable Tie to the parallel interface cable.
- B. Connect the parallel interface cable to the parallel interface port of the MFC and secure the wire clips.
- C. Connect the interface cable to the printer port of the computer and secure it with the two screws. For the location of your computer's parallel printer port, see the User's Guide for your computer.

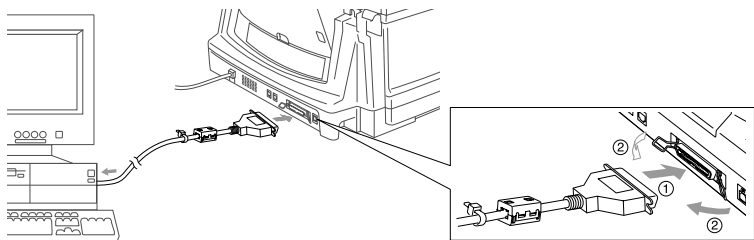

**Step 3.** Turn on the MFC by plugging in the power cord.

**Step 4.** Insert the CD-ROM into the CD-ROM drive. Then, follow the instructions on the screen.

(Same step as for Windows® 95/98/98SE/Me/2000 Users **Step 3.**, 1 to 9)

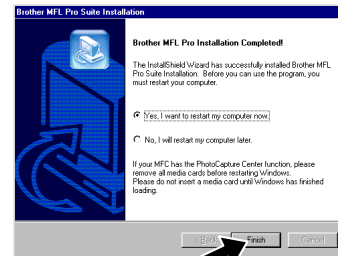

- 10.** Select **Yes** to restart your computer, and then click **Finish**.

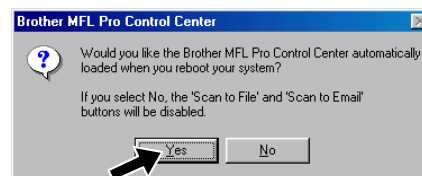

- 11.** Click **Yes** to have the Control Center loaded each time Windows is started. The Control Center will appear as an icon in the task bar. If you click **No**, the **Scan to** key on the MFC will be disabled.\*3

The Brother PC fax, Printer and Scanner drivers have been installed and the installation is now complete.

# For Apple® Macintosh® QuickDraw® Driver for OS 8.6/9.0/9.0.4/9.1 Users

**MAKE SURE THAT YOU FOLLOWED THE SET-UP INSTRUCTIONS ON PAGE 1 TO 3 BEFORE CONTINUING**

**Step 1.** Make sure your MFC power cord is unplugged and your Macintosh is turned on.

**!** Make sure you do NOT connect your MFC to your Macintosh

**Step 2.** Insert the CD-ROM into your CD-ROM drive.

Installing MFL Pro Driver

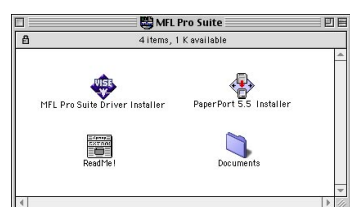

- 1.** When the window appears, double-click **MFL PRO Suite Driver Installer** to install the printer and scanner drivers. After the installation is completed, the screen prompts you to restart your Macintosh.

**Step 3.** Restart your Macintosh so it can recognize the new driver.

**Step 4.** Connect the MFC to your Macintosh with the USB cable, and then turn on the MFC by plugging in the power cord.

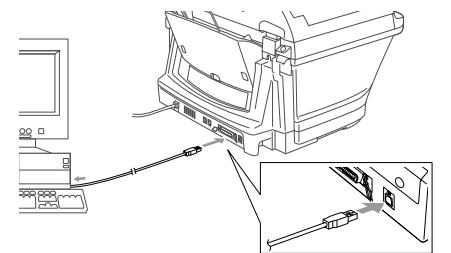

**Step 5.** Select the Printer.

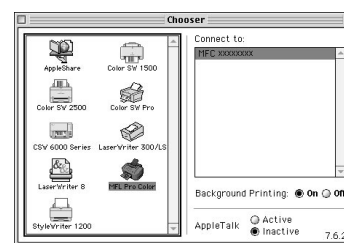

- 1.** From the Apple menu, open the **Chooser**.  
**2.** Click to **MFL Pro Color** icon you installed. On the right side of the **Chooser**, select the printer to which you want to print. Close the **Chooser**.

**Step 6.** Install Paper Port.

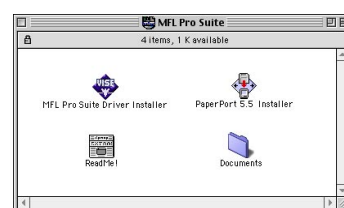

- 1.** Double-click the **PaperPort®5.5 Installer**. \*1  
**2.** Follow the instructions on the screen.

The Brother PC fax, Printer and Scanner drivers have been installed and the installation is now complete.

## What is included on the CD-ROM

### Windows

You can get a variety of information from this CD-ROM



(For Windows®)

#### Install Software

You can install printer, PC Fax Send, scanner drivers and the various utility items, including Paper Port and TextBridge OCR.

#### On-Line Registration

You will be pointed to a directory on the Brother Product Registration Web page.

#### On-Line Documentation

View the Owner's Manual and other documentation.

#### Brother Support

Get all contact you need if you have to get in touch with our Customer Service, or Brother Authorized Service Center.

#### Help

Helpful hints.

### Macintosh

You can get a variety of information from this CD-ROM



(For Macintosh®)

#### MFL Pro Suite Driver Installer

You can install the PC Fax Send, printer and scanner drivers and the various utility items.

#### PaperPort 5.5 Installer

You can install a document management application used to view scanned documents.

#### ReadMe!

You can get important information and troubleshooting tips.

#### Documents

View the Owner's Manual and other documentations.