

MFC-640CW

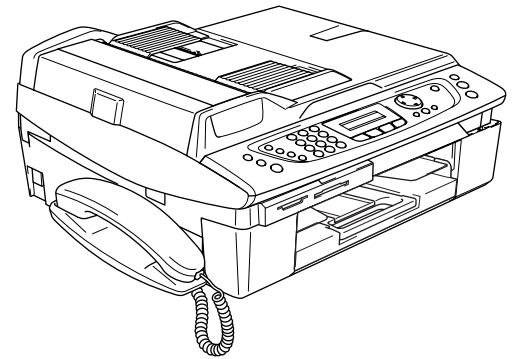

Before you can use the machine, you must set up the hardware and install the software. Please read this 'Quick Setup Guide' for the correct setup procedure and installation instructions.

STEP 1

Setting Up the Machine







STEP 2

Installing the Driver & Software

Setup is Complete!

Keep this 'Quick Setup Guide', the User's Guide and the supplied CD-ROM in a convenient place for quick and easy reference at all times.

To use the machine safely

 Warning	 Caution	 Improper Setup
Warnings tell you what to do to prevent possible personal injury.	Cautions specify procedures you must follow or avoid to prevent possible damage to the machine or other objects.	Improper Setup icons alert you to devices and operations that are not compatible with the machine.
 Note	 User's Guide, Software User's Guide or Network User's Guide	
Notes tell you how you should respond to a situation that may arise or give tips about how the current operation works with other features.	Indicates reference to the User's Guide, Software User's Guide or Network User's Guide which is on the CD-ROM we have supplied.	

Getting Started

Carton components	2
Control panel	3

STEP1 – Setting Up the Machine

Removing the protective parts	4
Installing the handset	4
Loading paper	4
Installing the phone line and power cord	5
Installing the ink cartridges	6
Print quality check	8
Setting the date and time	9
Setting your station ID	10
Choosing a Receive Mode	10
Setting up the Message Center	11
Choosing Your Language (Canada only)	11
Sending in the Product Registration and Test Sheet (USA only)	11

STEP2 – Installing the Driver & Software

Windows®

For USB Interface Users (For Windows® 98/98SE/Me/2000 Professional/XP)	14
For Wired Network Interface Users (For Windows® 98/98SE/Me/2000 Professional/XP)	17
For Wireless Network Users (For Windows® 98/98SE/Me/2000 Professional/XP in infrastructure mode)	20

Macintosh®

For USB Interface Users	24
For Mac OS® X 10.2.4 or greater	24
For Mac OS® 9.1 to 9.2	27
For Wired Network Interface Users	29
For Mac OS® X 10.2.4 or greater	29
For Mac OS® 9.1 to 9.2	32
For Wireless Network Users	34
For Mac OS® X 10.2.4 or greater in infrastructure mode	34

For Network Users

Installing the BRAdmin Professional configuration utility	39
Setting your IP address, Subnet Mask and Gateway using BRAdmin Professional (For Windows® users)	39
How to set the machine's network settings to wireless LAN or wired LAN	40

Consumables





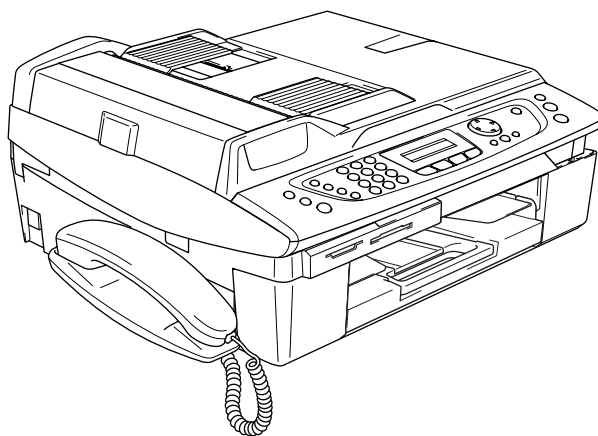

Replacement consumables	41
Ink cartridge	41

Carton components

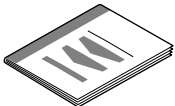
Carton components may vary from one country to another.

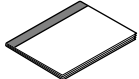
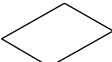
Save all packing materials and the carton in case for any reason you must ship your machine.

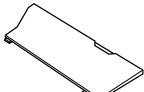
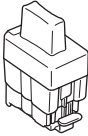
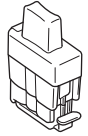
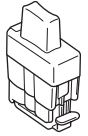
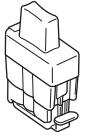

 Quick Setup Guide	 CD-ROMs For Windows® For Macintosh®	 User's Guide	 Accessory Order Form
 Telephone Handset	 Telephone Line Cord	 Test Sheet (USA only)	 Side Cover
 Black (LC41 BK)	 Magenta (LC41M)	 Yellow (LC41Y)	 Cyan (LC41C)
Ink Cartridges			

An interface cable is not a standard accessory. Buy the proper interface cable for the interface you want to use (USB or network).

USB cable

- Please make sure you use a USB 2.0 cable that is no longer than 6 feet long (2 meters).
- Your MFC has a USB 2.0 Full-Speed interface. This interface is compatible with Hi-Speed USB 2.0; however, the maximum data transfer rate will be 12 Mbits/s. The MFC can also be connected to a computer that has a USB 1.1 interface.
- DO NOT connect the interface cable at this time.
Connecting the interface cable is done during the software installation process.
When you use a USB cable, make sure you connect it to the USB port of your computer and not to a USB port on a keyboard or a non-powered USB hub.

Network cable

- Use a straight-through Category5 (or greater) twisted-pair cable for 10BASE-T or 100BASE-TX Fast Ethernet Network.

Control panel

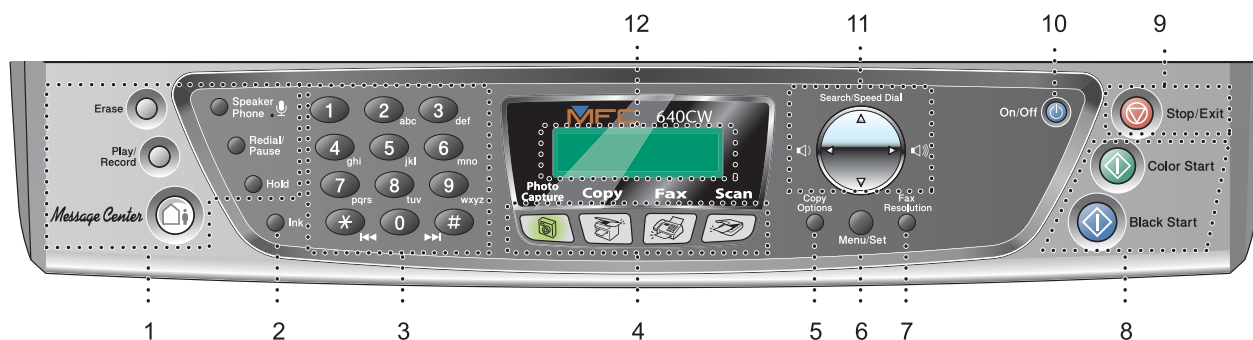

- | | |
|-------------------------------------|---------------------------------|
| 1 Telephone and Message Center keys | 7 Fax Resolution key |
| 2 Ink key | 8 Start keys |
| 3 Dial Pad | 9 Stop/Exit key |
| 4 Mode keys | 10 On/Off key |
| 5 Copy Options key | 11 Navigation keys |
| 6 Menu/Set key | 12 LCD (Liquid Crystal Display) |

 For the details of the control panel, see *Control panel overview* in Chapter 1 of the User's Guide.

- The screens for Windows® in this Quick Setup Guide are based on Windows® XP.
- The screens for Mac OS® in this Quick Setup Guide are based on Mac OS® X 10.3.

1 Removing the protective parts

- 1 Remove the protective tape and scanner glass protection sheet.

⊘ Improper Setup

DO NOT connect the USB cable. Connecting the USB cable is done during the software installation process.

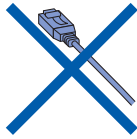

2 Installing the handset

- 1 Connect the curled handset cord to the handset.

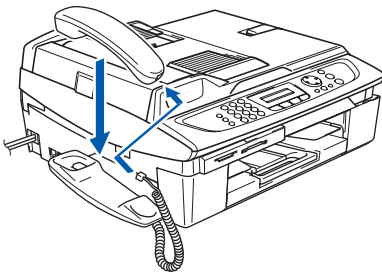

3 Loading paper



You can load up to 100 sheets of 20 lb (80 g/m²) paper. For details, see About paper in Chapter 1 of the User's Guide.

- 1 Pull the paper tray completely out of the machine and remove the output paper tray (1).

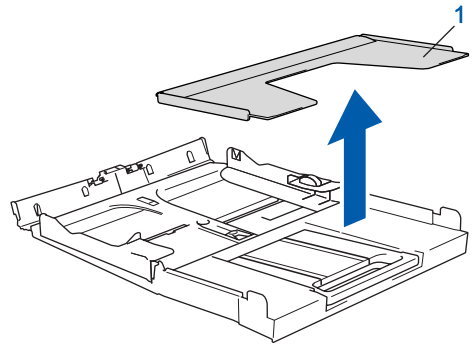
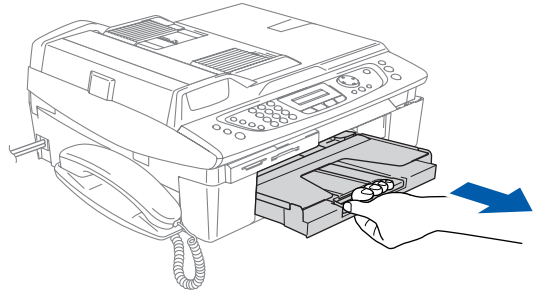

- 2 Press and slide the paper guide (1) to fit the paper width.

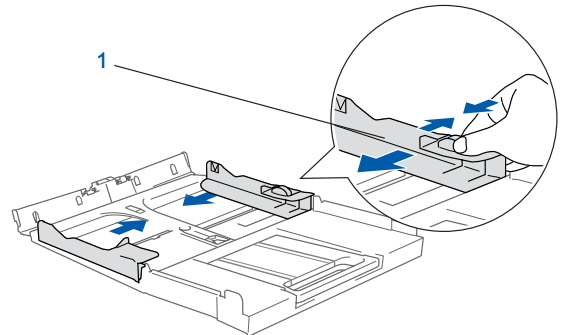

- 3 Pull out the paper support (1) and unfold the paper support flap (2).

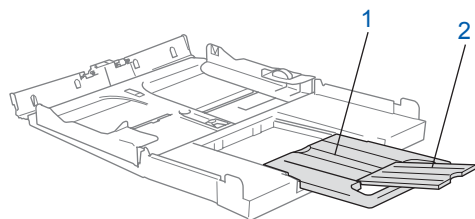

Note

Use the paper support flap for Letter, Legal and A4 paper.

- 4** Fan the stack of paper well to avoid paper jams and misfeeds.

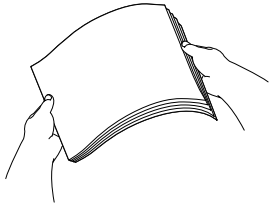

- 5** Gently put the paper into the paper tray print side down and top edge first. Check that the paper is flat in the tray and below the maximum paper mark (1).

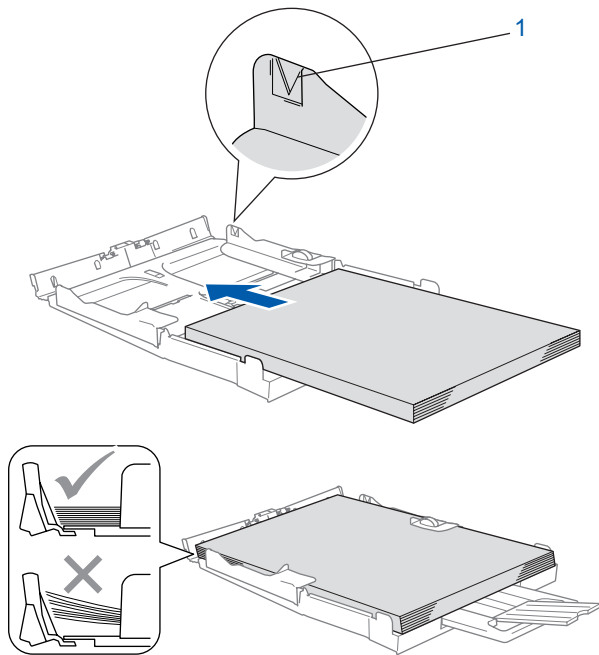

Note

- Make sure the paper side guides touch the sides of the paper.
- Be careful that you do not push the paper in too far; it may lift at the back of the tray and cause paper feed problems.

- 6** Put the output paper tray back on and push the paper tray firmly back into the machine.

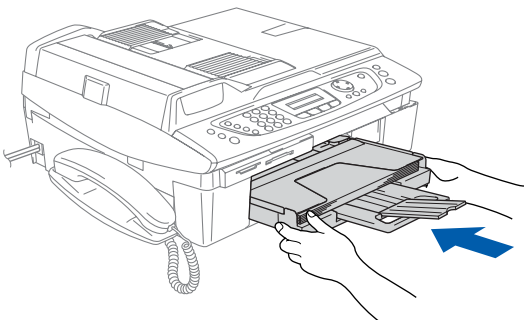

4 Installing the phone line and power cord

- 1** Connect the power cord.

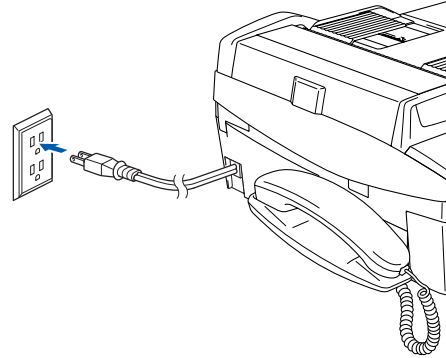

- 2** Connect the telephone line cord. Connect one end of the telephone line cord to the jack on the machine marked **LINE** and the other end to a modular wall jack.

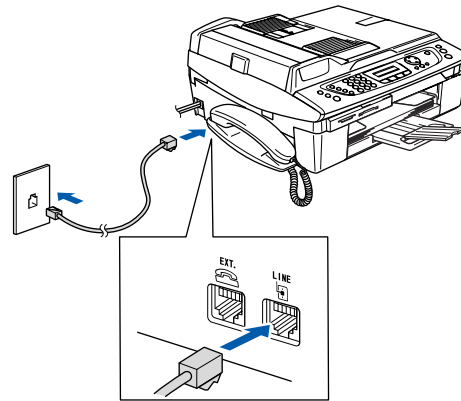

⊘ Improper Setup

DO NOT connect the USB cable. Connecting the USB cable is done during the software installation process.

Note

If you are sharing one phone line with an external telephone, connect it as shown below.

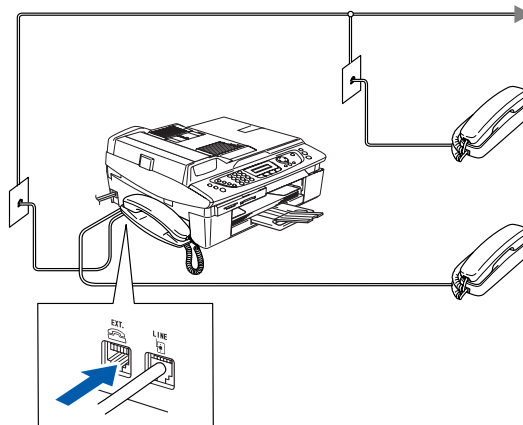

5 Installing the ink cartridges

Warning

If ink gets in your eyes, wash them out with water at once, and if irritation occurs consult a doctor.

- 1 Make sure that the power is turned on.
The LCD shows:

```
No Cartridge
Open scanner...
```

- 2 Lift the scanner cover (1) from the right-hand side of the machine until it locks securely into the open position.

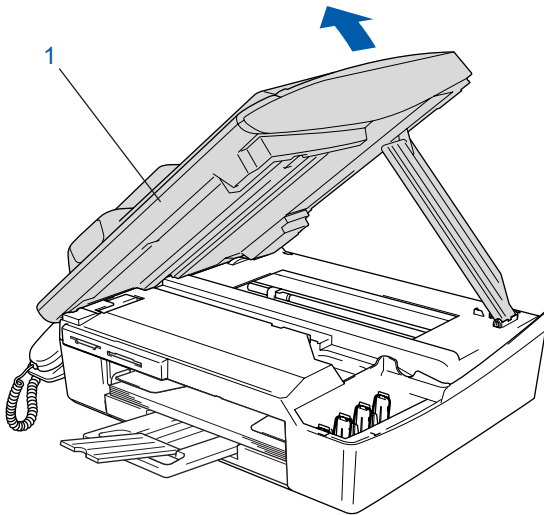

- 3 Remove the yellow protective parts (1).

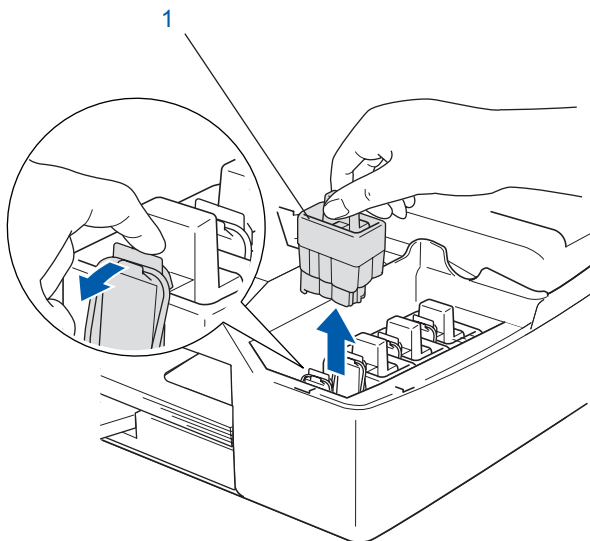

Note

Do not throw away the yellow protective parts. You will need them if you transport the machine.

- 4 Take out the ink cartridge.

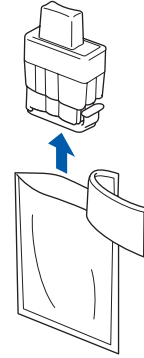

- 5 Carefully remove the protective yellow cap (1).

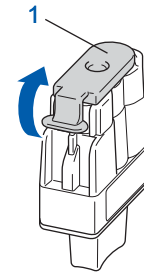

Improper Setup

DO NOT touch the area shown in the illustration below.

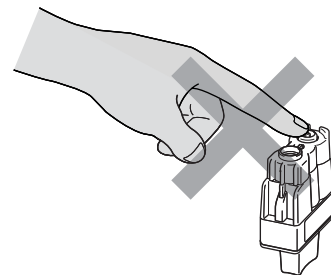

Note

If the protective yellow cap comes off when you open the bag, the cartridge will not be damaged.

Keep the ink cartridge in an upright position when you put it into the slot.

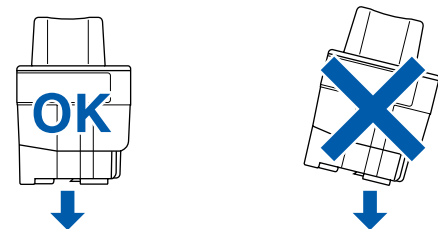

- 6** Press firmly down on the ink cartridge until the hook snaps over it, taking care to match the slot color (1) with the cartridge color (2), as shown in the diagram below.

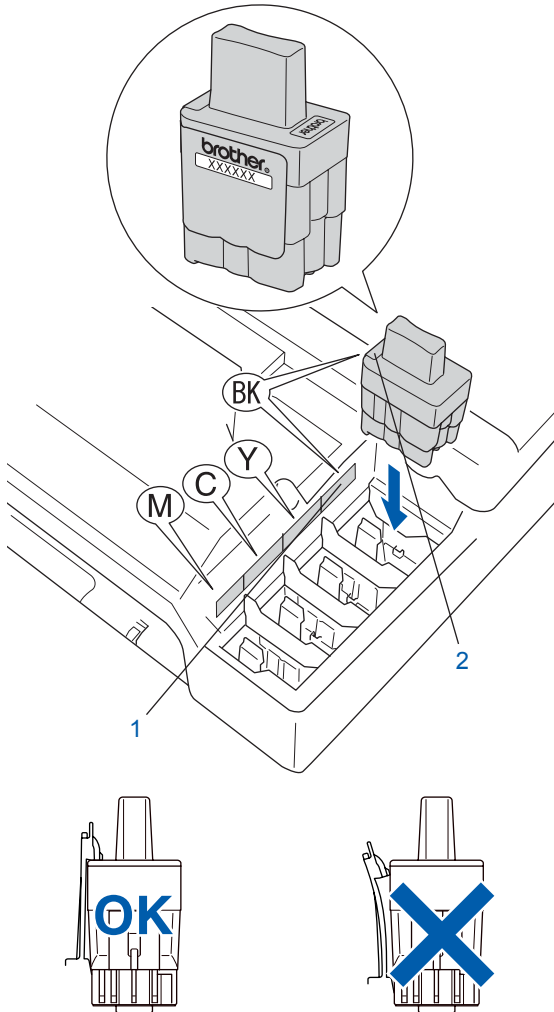

- 7** Lift the scanner cover to release the lock. Gently push the scanner cover support down and close the scanner cover.



Note

If the LCD shows *Install xxxx* after you install the ink cartridges, check that the ink cartridges are installed properly.

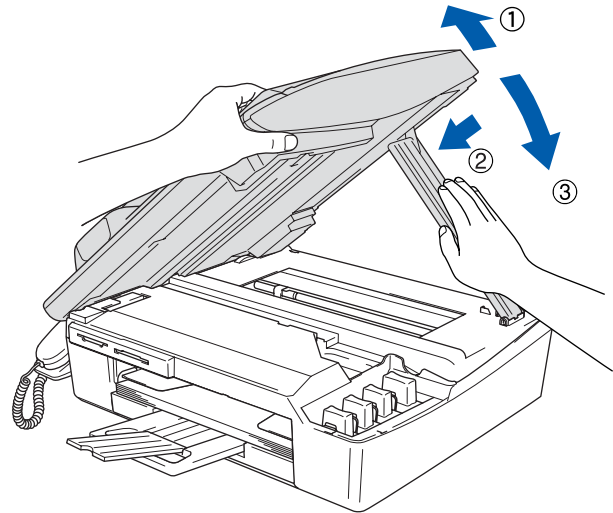

The machine will clean the ink tube system for use for the first time. This process will occur only once, the first time ink cartridges are installed. The cleaning process will last approximately four minutes.

The LCD shows:

Preparing System
Approx 4 Minutes

Cleaning
Please Wait

! Caution

- DO NOT take out ink cartridges if you do not need to replace them. If you do so, it may reduce the ink quantity and the machine will not know the quantity of ink left in the cartridge.
- DO NOT shake the ink cartridges. If ink stains your skin or clothing, wash with soap or detergent at once.
- DO NOT repeatedly insert and remove the cartridges. If you do so, ink may seep out of the cartridge.
- If you mix the colors by installing an ink cartridge in the wrong position, clean the print head several times after correcting the cartridge installation. (See *Cleaning the print head in Chapter 13 of the User's Guide.*)
- Once you open an ink cartridge, install it in the machine and use it up within six months of installation. Use unopened ink cartridges by the expiration date written on the cartridge package.
- DO NOT dismantle or tamper with the ink cartridge, this can cause the ink to leak out of the cartridge.
- Brother strongly recommends that you do not refill the ink cartridges provided with your machine. We also strongly recommend that you continue to use only Genuine Brother Brand replacement ink cartridges. Using or attempting to use potentially incompatible inks and/or cartridges in your machine may cause damage to the machine itself and/or it may result in unsatisfactory print quality. Our warranty coverage does not apply to any problem that was caused by the use of unauthorized third party ink and/or cartridges. To protect your investment and guarantee your print quality please continue to replace consumed ink cartridges with only Genuine Brother Branded Supplies.

6 Print quality check

- 1 After the cleaning cycle is finished, the LCD shows:

Set Paper and
Press Start

- 2 Make sure the paper is loaded in the paper tray.

Press **Color Start**.

The machine starts printing the Print Quality Check Sheet (only during initial ink cartridge installation).

- 3 Check the quality of the four color blocks on the sheet.
(black/ cyan/ yellow/ magenta)



⊘ Improper Setup

Avoid touching the printed surface of the paper immediately after printing, the surface may not be completely dry and may stain your fingers.

- 4 The LCD shows:

Is Quality OK?
1.Yes 2.No

- 5 Do one of the following:

- If all lines are clear and visible, press **1** (Yes) on the dial pad to finish the quality check.
- If you can see missing short lines, press **2** (No) on the dial pad and go to step **6**.

OK

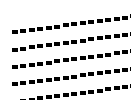

Poor



- 6** The LCD asks you if the print quality is OK for black and color. Press **1** (Yes) or **2** (No) on the dial pad.

```
Black OK?  
1.Yes 2.No
```

After pressing **1** (Yes) or **2** (No) for both black and color, the LCD shows:

```
Start Cleaning?  
1.Yes 2.No
```

- 7** Press **1** (Yes), the machine will then start cleaning the colors.
- 8** After cleaning is finished, press **Color Start**. The machine starts printing the Print Quality Check Sheet again and goes back to step **3**.

7 Setting the date and time

The machine displays the date and time, and prints it on the fax you send.

- 1** Press **Menu/Set**.
- 2** Press **0**.
- 3** Press **2**.
- 4** Enter the last two digits of the year on the dial pad, and then press **Menu/Set**.

```
Date/Time  
Year:2005
```

(e.g. Enter **0 5** for 2005.)

- 5** Enter the two digits for the month on the dial pad, and then press **Menu/Set**.

```
Date/Time  
Month:03
```

(e.g. Enter **0 3** for March.)

- 6** Enter the two digits for the day on the dial pad, and then press **Menu/Set**.

```
Date/Time  
Day:01
```

(e.g. Enter **0 1** for the first of the month.)

- 7** Enter the time in 24-hour format on the dial pad, and then press **Menu/Set**.

```
Date/Time  
Time:15:25
```

(e.g. Enter **1 5, 2 5** for 3:25 P.M.)

- 8** Press **Stop/Exit**.



To confirm the current date and time, print out the Users Settings Report. (See "Printing reports" in Chapter 8 of the User's Guide.)

8 Setting your station ID

You should store your name and fax number to be printed on all fax pages that you send.

- 1 Press **Menu/Set**.
- 2 Press **0**.
- 3 Press **3**.
- 4 Enter your fax number (up to 20 digits) on the dial pad, and then press **Menu/Set**.

```
Station ID
Fax: _
```

- 5 Enter your name (up to 20 characters) using the dial pad, and then press **Menu/Set**.

```
Station ID
Name: _
```



Note

See the following chart for entering your name. If you need to enter a character that is on the same key as the last character, press to move the cursor to the right.

Press key	One time	Two times	Three times	Four times
2	A	B	C	2
3	D	E	F	3
4	G	H	I	4
5	J	K	L	5
6	M	N	O	6
7	P	Q	R	S
8	T	U	V	8
9	W	X	Y	Z

- 6 Press **Stop/Exit**.



Note

If you want to repeat input, press **Stop/Exit** to start from step 1.



For details, see *Setting the Station ID* in Chapter 2 or *Entering Text* in Appendix B of the User's Guide.

9 Choosing a Receive Mode

There are three possible receive modes: Fax Only, Fax/Tel and Manual.

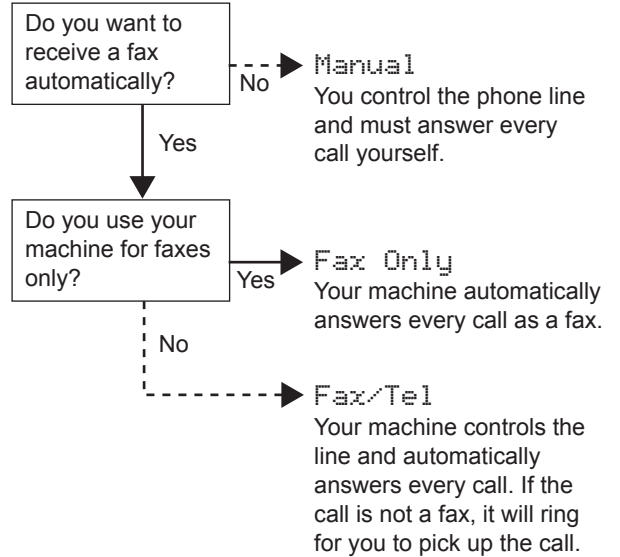

- 1 Press **Menu/Set**.
- 2 Press **0**.
- 3 Press **1**.
- 4 Press **▲** or **▼** to choose the mode.
- 5 Press **Menu/Set**.
- 6 Press **Stop/Exit**.



For details, see *Setup Receive* in Chapter 4 of the User's Guide.

10 Setting up the Message Center

You must record an outgoing message in order to use the Message Center mode.

- 1 Record the Message Center Outgoing Message (MSG CTR OGM).

 See *Recording Message Center Outgoing Message* in Chapter 7 of the User's Guide.

- 2 Activate Message Center mode.

Press and hold  until it lights and the LCD shows:

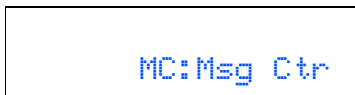

 If the Message Center Mode is on, it overrides your Receive Mode setting. The built-in digital Message Center answers voice calls. If the call is a fax, you can receive a fax automatically. For details, see Message Center in Chapter 7 of the User's Guide.

11 Choosing Your Language (Canada only)

- 1 Press **Menu/Set**.
- 2 Press **0**.
- 3 Press **0**.
- 4 Press **▲** or **▼** to choose your language (English or French), and then press **Menu/Set**.





- 5 Press **Stop/Exit**.

12 Sending in the Product Registration and Test Sheet (USA only)

- 1 Fill out the Product Registration and Test Sheet.

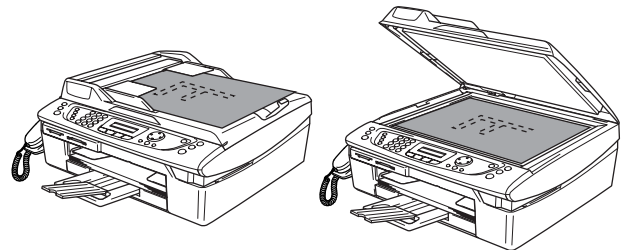
- 2 Put the sheet face down in the ADF (Automatic Document Feeder) or the scanner glass.



- 3 Make sure  (Fax) is illuminated in Green.
- 4 Enter the toll-free fax number: 1-877-268-9575.
- 5 Press **Black Start**.

Note

You will receive a confirmation fax of your Product Registration. You can also register your product online using the On-Line Registration link from the installation CD-ROM or visit <http://www.brother.com/registration>

Now go to

Go to *Supplied CD-ROM 'MFL-Pro Suite'* on the next page to install the drivers.

Supplied CD-ROM 'MFL-Pro Suite'

Windows®



Install MFL-Pro Suite

You can install the MFL-Pro Suite software and multifunction drivers.



Install Optional Applications

You can install additional MFL-Pro Suite software utilities.



Documentation

View the User's Guide and other documents in PDF format (Viewer included). The User's Guide on the CD-ROM includes the Software and Network User's Guides for features available when connected to a computer (e.g. Printing, Scanning and wireless networking details).



On-Line Registration

You will be pointed to the Brother Product Registration Web page for quick registration of your machine.



Brother Support

View contact information for Brother Customer Service and how to find a Brother Authorized Service Center.



Repair MFL-Pro Suite (USB only)

If an error occurred during the installation of the MFL-Pro Suite, use this selection to automatically repair and re-install the MFL-Pro Suite.



Note

MFL-Pro Suite includes Printer Driver, Scanner Driver, ScanSoft® PaperPort® 9.0SE, ScanSoft® OmniPage® and True Type® fonts.

PaperPort® 9.0SE is a document management application for viewing scanned documents.

ScanSoft® OmniPage®, which is integrated into PaperPort® 9.0SE, is an OCR application that converts an image into text and puts it into your default word processor.

Macintosh®



Start Here OS 9.1-9.2

You can install the printer driver, scanner driver and Presto!® PageManager® for Mac OS® 9.1-9.2.



Start Here OSX

You can install the MFL-Pro Suite that includes the printer driver, scanner driver and the Brother ControlCenter2 for Mac OS® 10.2.4 or greater. You can also install Presto!® PageManager® to add OCR capability to the Brother ControlCenter2 and easily scan, share and organize photos and documents.



Readme.html

You can get important information and troubleshooting tips.



Documentation

View the User's Guide and other documents in PDF format. The User's Guide on the CD-ROM includes the Software and Network User's Guides for features available when connected to a computer (e.g. Printing, Scanning and wireless networking details).



Brother Solutions Center

You can access the Brother Solutions Center which is a Web site offering information about your Brother product including FAQs, User's Guides, driver updates and tips for using your machine.



On-Line Registration

You will be pointed to the Brother Product Registration Web Page for quick registration of your machine.

Follow the instructions on this page for your operating system and interface cable.
 For the latest drivers and documentations and to find the best solution for your problem or question, access the Brother Solutions Center directly from the driver or visit <http://solutions.brother.com>

Windows®

For USB Interface Users
 (For Windows® 98/98SE/Me/2000 Professional/XP)..... 14



For Wired Network Interface Users
 (For Windows® 98/98SE/Me/2000 Professional/XP)..... 17



For Wireless Network Users
 (For Windows® 98/98SE/Me/2000 Professional/XP in infrastructure mode) 20



For other setup methods supported, see the Network User's Guide on the CD-ROM for installation details.

Macintosh®

For USB Interface Users 24

- For Mac OS® X 10.2.4 or greater..... 24
- For Mac OS® 9.1 to 9.2 27



For Wired Network Interface Users 29

- For Mac OS® X 10.2.4 or greater..... 29
- For Mac OS® 9.1 to 9.2 32



For Wireless Network Users 34

- For Mac OS® X 10.2.4 or greater in infrastructure mode 34



For other setup methods supported, see the Network User's Guide on the CD-ROM for installation details.

Windows® XP Professional x64 Edition:



Visit the Brother Solutions Center (<http://solutions.brother.com>) for driver downloads and installation steps.

For USB Interface Users (For Windows® 98/98SE/Me/2000 Professional/XP)

Important

Make sure that you have finished the instructions from Step 1 *Setting Up the Machine* on page 4-11.

Note

- Please close any applications running before installing MFL-Pro Suite.
- Make sure there are no media cards put into the media drive of the machine.

- 1 Unplug the machine from the AC outlet and from your computer, if you already connected an interface cable.

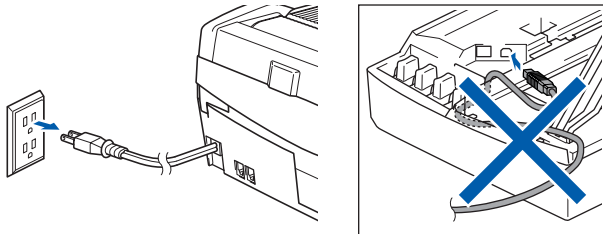

- 2 Turn on your PC.
(For Windows® 2000 Professional/XP, you must be logged on with Administrator rights.)
- 3 Put the supplied CD-ROM into your CD-ROM drive. If the model name screen appears, choose your machine. If the language screen appears, choose your language.



- 4 The CD-ROM main menu will appear. Click **Install MFL-Pro Suite**.

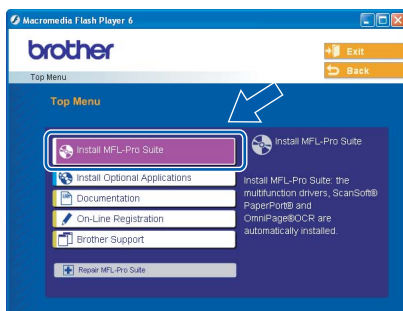

Note

- If this window does not appear, use Windows® Explorer to run the **setup.exe** program from the root folder of the Brother CD-ROM.
- If you are using Windows® 2000 Professional and have not installed service pack 3 (SP3) or greater:
To access the PhotoCapture Center™ features from your computer you may have to install a Windows® 2000 update first.
The Windows® 2000 update is included with the MFL-Pro Suite installer.
To install the update, follow the steps below:
1 Click **OK** to start installation of the Windows® updates.

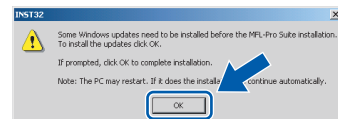

- 2 When instructed, click **OK** to restart your computer.
- 3 After the computer restarts, the installation of MFL-Pro Suite will automatically continue.
If the installation does not continue automatically, open the main menu again by ejecting and then reinserting the CD-ROM disc or double-click the **setup.exe** program from the root folder, and continue from Step 4 to install the MFL-Pro Suite.

- 5 Choose **Local Connection**, and then click **Next**. The installation continues.

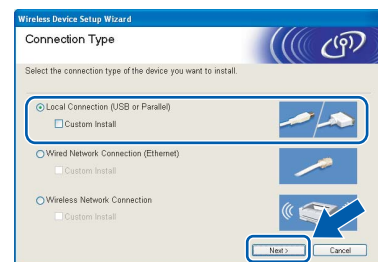

- 6 After reading and accepting the ScanSoft® PaperPort® 9.0SE License Agreement, click **Yes**.

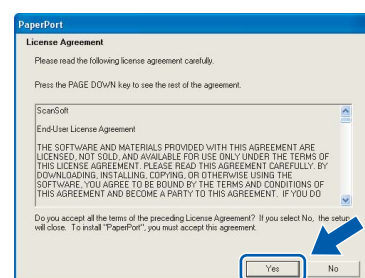

7 The installation of PaperPort® 9.0SE will automatically start and is followed by the installation of MFL-Pro Suite.

8 When the Brother MFL-Pro Suite Software License Agreement window appears, click **Yes** if you agree to the Software License Agreement.

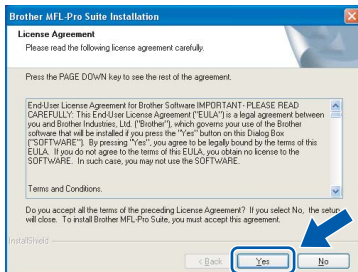

9 When this screen appears, go to the next step.

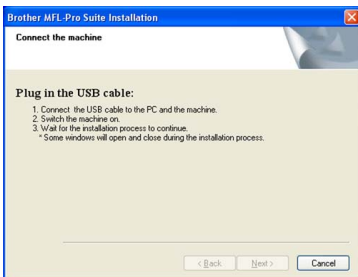

10 Open the scanner cover to its open position.

11 Connect the USB cable to the USB socket marked with a  symbol. You will find the USB socket above and to the left of the ink cartridge slots, as shown below.

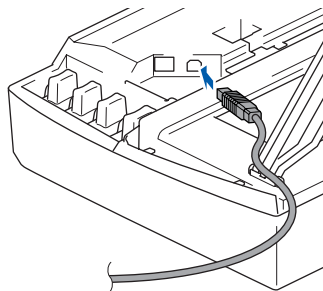

12 Carefully route the USB cable through the trench and out the back of the machine as shown below.

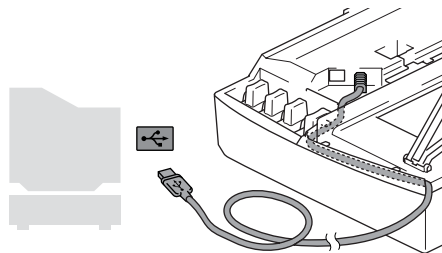

⊘ Improper Setup

- **DO NOT** connect the machine to a USB port on a keyboard or a non-powered USB hub. Brother recommends that you connect the machine directly to your computer.
- **Make sure** that the cable does not restrict the cover from closing, or an error may occur.

13 Lift the scanner cover to release the lock. Gently push the scanner cover support down and close the scanner cover.

14 Turn on the machine by plugging in the power cord.

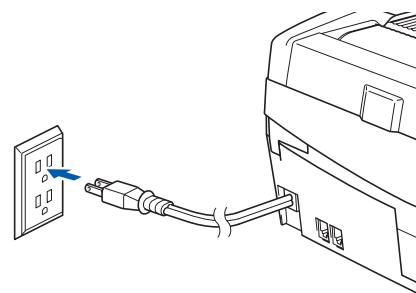

It will take a few seconds for the installation screens to appear. The installation of the Brother drivers will automatically start. The installation screens appear one after another. **Please wait, it will take a few seconds for all screens to appear.**

⊘ Improper Setup

DO NOT try to cancel any of the screens during this installation.

- 15** When the on-line Registration screen is displayed, make your selection and follow the on-screen instructions.

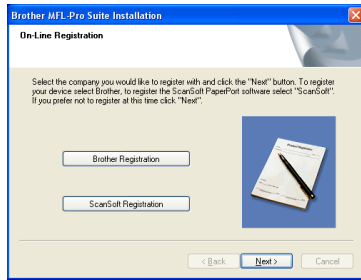

- 16** Click **Finish** to restart your computer.
(After restarting the computer, for Windows® 2000 Professional/XP, you must be logged on with Administrator rights.)



Note

After restarting the computer, the Installation Diagnostics will run automatically. If the installation is unsuccessful, the installation results window will be shown. If the Diagnostics shows a failure, please follow the on-screen instruction or read on-line help and FAQ's in Start/All Programs /Brother/MFL-Pro Suite MFC-XXXX.



The MFL-Pro Suite (including Brother Printer driver and Scanner driver) has been installed and the installation is now complete.

For Wired Network Interface Users (For Windows® 98/98SE/Me/2000 Professional/XP)

Important

Make sure that you have finished the instructions from Step 1 *Setting Up the Machine* on page 4-11.

- 1 Unplug the machine from the AC outlet.
- 2 Open the scanner cover to its open position.
- 3 Insert the network cable to the LAN socket marked with a  symbol. You will find the LAN socket above and to the left of the ink cartridge slots, as shown below.

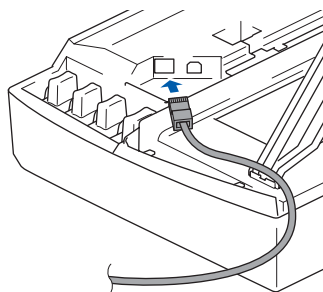

- 4 Carefully route the network cable through the trench and out the back of the machine. Then, connect the cable to your network.

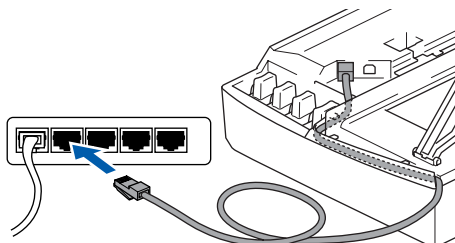

⊘ Improper Setup

Make sure that the cable does not restrict the cover from closing, or an error may occur.

Note

In case of using both USB and LAN cables, route both cables into the trench with one on top of the other.

- 5 Lift the scanner cover to release the lock. Gently push the scanner cover support down and close the scanner cover.

- 6 Turn on the machine by plugging in the power cord.

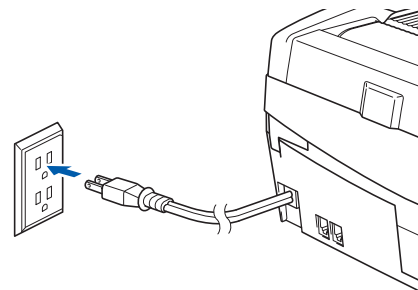

⊘ Improper Setup

If you have setup wireless networking on your machine before and you setup the wired network, you should check that the machine's **Network I/F** setting is set to **wired LAN**. The wireless network interface will be inactive with this setting.

Press **Menu/Set**, **5**, **6**, and then press **▲** or **▼** to choose **wired LAN**. Press **Menu/Set** and then press **1 1**. **Yes** to accept the change. The machine will restart automatically.

- 7 Turn on your computer. (For Windows® 2000 Professional/XP, you must be logged on with Administrator rights.) Close any applications running before installing the MFL-Pro Suite.

Note

Before installation, if you are using personal firewall software, disable it. Once you are sure that you can print after the installation, restart your personal firewall software.

- 8 Put the supplied CD-ROM into your CD-ROM drive. If the model name screen appears, choose your machine. If the language screen appears, choose your language.



- 9 The CD-ROM main menu will appear. Click **Install MFL-Pro Suite**.



Note

- If this window does not appear, use Windows® Explorer to run the **setup.exe** program from the root folder of the Brother CD-ROM.
- If you see the following screen, click **OK** to install the Windows® updates. After the updates are installed your PC may restart. Then the installation will automatically continue.

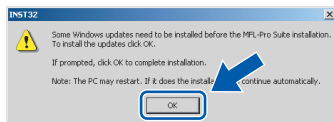

If the installation does not continue automatically, open the main menu again by ejecting then reinserting the CD-ROM disc or double-click the **setup.exe** program from the root folder, and continue from Step 9 to install the MFL-Pro Suite.

- 10 Choose **Wired Network Connection**, and then click **Next**.

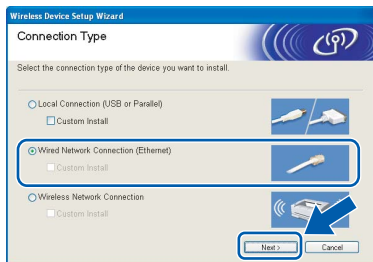

- 11 After reading and accepting the ScanSoft® PaperPort® 9.0SE License Agreement, click **Yes**.

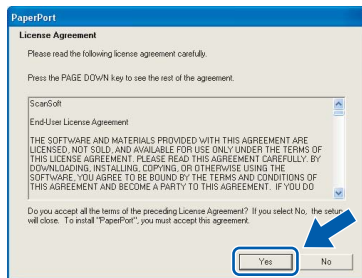

- 12 The installation of PaperPort® 9.0SE will automatically start and is followed by the installation of MFL-Pro Suite.

- 13 When the Brother MFL-Pro Suite Software License Agreement window appears, click **Yes** if you agree to the Software License Agreement.

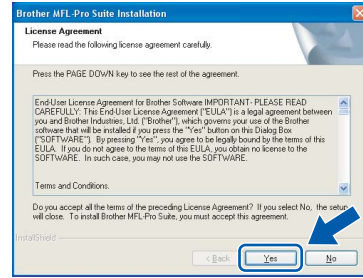

- 14 The installation of the Brother drivers will automatically start. **The installation screens appear one after another, please wait for a while.**

Improper Setup

DO NOT try to cancel any of the screens during this installation.

- 15 If the machine is configured for your network, choose the machine from the list, and then click **Next**.

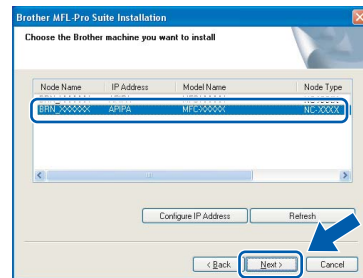

Note

This window will not appear if there is only one machine connected on the network, it will be chosen automatically.

- 16 If the machine is not yet configured for use on your network, the following screen appears.



Click **OK**. The **Configure IP Address** window will appear. Enter the proper IP address information for your network by following the on-screen instructions.

- 17** When the Brother and ScanSoft on-line Registration screen is displayed, make your selection and follow the on-screen instructions.

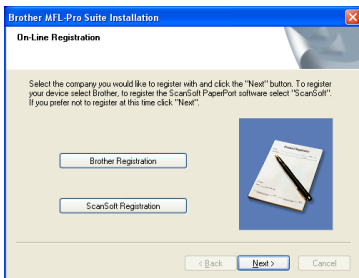

- 18** Click **Finish** to restart your computer.
(For Windows® 2000 Professional/XP, you must be logged on with Administrator rights.)

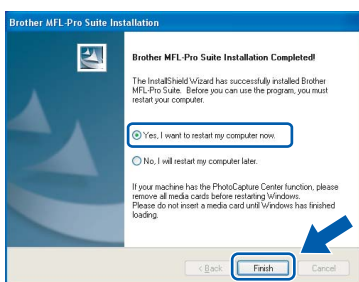

Note

After restarting the computer, the Installation Diagnostics will run automatically. If the installation is unsuccessful, the installation results window will be shown. If the Diagnostics shows a failure, please follow the on-screen instruction or read on-line help and FAQ's in Start/All Programs/ Brother/MFL-Pro Suite MFC-XXXX.



The MFL-Pro Suite (including Brother Network Printer driver, Network Scanner driver and Network PhotoCapture Center™) has been installed and the installation is now complete.

For Wireless Network Users (For Windows® 98/98SE/Me/2000 Professional/XP in infrastructure mode)

Important

Make sure that you have finished the instructions from Step 1 *Setting Up the Machine* on page 4-11.

These instructions will install your Brother machine in a typical small office or home wireless network environment in infrastructure mode, using a wireless router or access point that uses DHCP to assign IP addresses.

If you want to setup your machine in any other wireless environment you can find instructions in the Network User's Guide on the CD-ROM.

You can view the Network User's Guide by following the instructions below.

- 1 Turn on your PC. Insert the Brother CD-ROM labeled Windows® into your CD-ROM drive.
- 2 If the model name screen appears, click your model name.
- 3 If the language screen appears, click your language. The CD-ROM main menu will appear.
- 4 Click **Documentation**.
- 5 Click the **User's Guide**.
- 6 Click the **Network User's Guide**.

Note

If the window does not appear, use Windows® Explorer to run the setup.exe program from the root directory of the Brother CD-ROM.

To achieve optimum results with normal every day document printing, place the Brother machine as close to the network access point (router) as possible with minimal obstructions. Large objects and walls between the two devices as well as interference from other electronic devices can affect the data transfer speed of your documents.

Due to these factors, wireless may not be the best method of connection for all types of documents and applications. If you are printing large files, such as photos on glossy paper or multi-page documents with mixed text and large graphics, you may want to consider choosing wired Ethernet for a faster data transfer, or USB for the fastest throughput speed.

First you must configure the wireless network settings of your machine to communicate with your network access point (router). After the machine is configured to communicate with your access point computers on your network will have access to the machine. To use the machine from these computers, you will need to install the MFL-Pro Software Suite. The following steps will guide you through the configuration and installation process.



- 1 Write down the wireless network settings of your access point or wireless router.

SSID (Service Set ID or Network name)

WEP Key (if needed)

WPA-PSK (TKIP) (if needed)

The WEP key is for 64bit encrypted networks or 128 bit encrypted networks and can contain both numbers and letters. If you do not know this information you should see the documentation provided with your access point or wireless router. This key is a 64-bit or 128-bit value that must be entered in an ASCII or HEXADECIMAL format.

For example:

64 bit ASCII: Uses 5 text characters.
e.g. "Hello" (this is case sensitive)

64 bit Hexadecimal: Uses 10 digits of hexadecimal data.
e.g. "71f2234aba"

128 bit ASCII: Uses 13 text characters.
e.g. "Wirelesscomms" (this is case sensitive)

128 bit Hexadecimal: Uses 26 digits of hexadecimal data.
e.g. "71f2234ab56cd709e5412aa3ba"

WPA-PSK enables a Protected Access Pre-shared key that allows the Brother wireless machine to associate with access points using TKIP encryption. WPA-PSK uses a Pre-Shared Key that is more than 7 and less than 64 characters in length.

Note

Your machine supports WEP and WPA-PSK(TKIP). WPA-PSK(AES) is not supported.

See Chapter 3 of the Network User's Guide for more details.

- 2** Turn on the machine by plugging in the power cord.

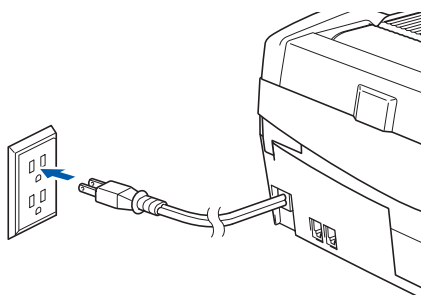

⊘ Improper Setup

If you have previously configured the wireless settings of the machine you must reset the network (LAN) settings before you can configure the wireless settings again.

Press **Menu/Set**, **5**, **0**, **1** and then press **1 1 . Yes** to accept the change.

The machine will restart automatically.

- 3** On your machine, press **Menu/Set**, **5**, **6**, then press **▲** or **▼** to choose **WLAN**, then press **Menu/Set**. Press **1 1 . Yes** to reboot the machine. The wired network interface will become inactive with this setting.

It will take about a minute for the LAN menu on the LCD to become available again.

A four level indicator on the right of your machine's LCD shows the wireless signal strength.

- 4** When the LAN menu becomes available, press **Menu/Set**, **5**, **3**, **1** to start the wireless setup wizard.

- 5** The machine will search for your network and display a list of available SSIDs. You should see the SSID you wrote down earlier. If the machine finds more than one network use the **▲** or **▼** keys to choose your network, then press **Menu/Set**.

- 6** Use the **▲**, **▼** and **Menu/Set** keys to choose one of the options below: If your network is configured for Authentication and Encryption you must match the settings used for your network.

No Authentication or Encryption: Choose **Open system**, press **Menu/Set** then choose **None** for **Encryption Type** and press **Menu/Set**. Then press **1 1 . Yes** to apply your settings. Go to step **9**.

No Authentication with WEP Encryption: Choose **Open system**, press **Menu/Set** then use the **▲** or **▼** to choose **WEP** for the **Encryption Type** and press **Menu/Set**. Go to step **7**.

Authentication with WEP Encryption: Choose **Shared Key**, press **Menu/Set**. Go to step **7**.

Authentication with WPA-PSK (TKIP) Encryption: Choose **WPA-PSK**, press **Menu/Set**. Go to step **8**.

- 7** Choose the appropriate key number and press **Menu/Set**. Enter the WEP key you wrote down in step **1** using the dial pad. You can use the **◀** and **▶** keys to move the cursor. For example, to enter the letter **a**, press the **1** key on the dial pad once. To enter the number **3**, press the **3** key on the dial pad seven times. The letters appear in this order: lower case, upper case, numbers and then special letters.

Press **Menu/Set** when you have entered all the characters, then press **1 1 . Yes** to apply your settings. Go to step **9**.

Most access points and routers can store more than one key, but they will only use one at any time for authentication and encryption.

- 8** Enter the WPA-PSK (TKIP) key **WPA** you wrote down in step **1** using the dial pad. You can use the **◀** and **▶** keys to move the cursor. For example, to enter the letter **a**, press the **1** key on the dial pad once. To enter the number **3**, press the **3** key on your dial pad seven times.

Press **Menu/Set** when you have entered all the characters, then press **1 1 . Yes** to apply your settings. Go to step **9**.

- 9** Your machine will now try to connect to your wireless network using the information you have entered. If successful, **Connected** will appear briefly on the LCD.

*If your machine does not successfully connect to your network, you should repeat steps **3** to **8** to make sure you have entered the correct information.*

10 Disconnect and then reconnect the power cord to turn the machine OFF and back ON. This will allow the machine to automatically acquire the correct TCP/IP address information from your access point (router) if DHCP is enabled (DHCP is normally enabled as default for most access point routers).

If your access point does not have DHCP enabled you will need to manually configure the IP address, subnet mask and gateway of the machine to suit your network. See the Network User's Guide for details.

OK! Wireless setup is now complete. To install the MFL-Pro Software suite, continue to step 11.

11 Turn on your computer. Close any applications running before installing the MFL-Pro Suite.

Note
Before installation, if you are using personal firewall software, disable it. Once you are sure that you can print after the installation, restart your personal firewall software.

12 Put the supplied CD-ROM into your CD-ROM drive. If the model name screen appears, choose your machine. If the language screen appears, choose your language.



13 The CD-ROM main menu will appear. Click **Install MFL-Pro Suite**.

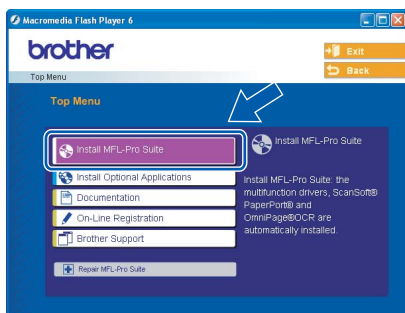

Note

- If this window does not appear, use Windows Explorer to run the **setup.exe** program from the root folder of the Brother CD-ROM.
- If you see the following screen, click **OK** to install the Windows updates. After the updates are installed your PC may restart. Then the installation will automatically continue.

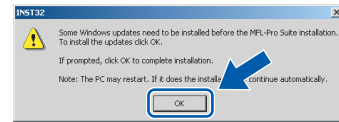

If the installation does not continue automatically, open the main menu again by ejecting then reinserting the CD-ROM disc or double-click the **setup.exe** program from the root folder, and continue from Step 13 to install the MFL-Pro Suite.

14 Choose **Wireless Network Connection**, and then click **Next**.

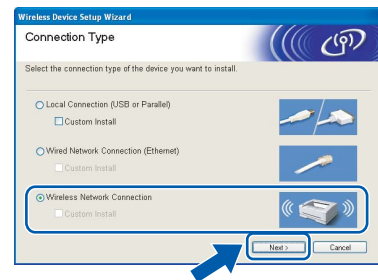

15 Choose **Driver Install Only**, and then click **Next**.

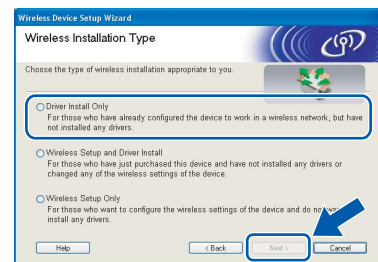

16 After reading and accepting the ScanSoft PaperPort 9.0SE License Agreement, click **Yes**.

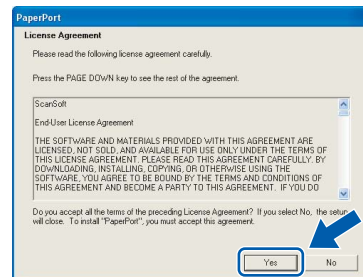

17 The installation of PaperPort® 9.0SE will automatically start and is followed by the installation of MFL-Pro Suite.

18 When the Brother MFL-Pro Suite Software License Agreement window appears, click **Yes** if you agree to the Software License Agreement.

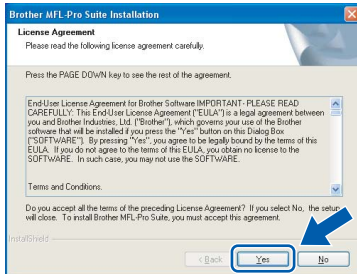

19 The installation of the Brother drivers will automatically start. **The installation screens appear one after another, please wait for a while.**

⚠ Improper Setup

- **DO NOT** try to cancel any of the screens during this installation.
- **If your wireless settings fail, an error message will appear during the installation of MFL-Pro Suite and the installation will be terminated. If you encounter this failure, please go to step 13 and setup the wireless connection again.**

20 Choose the machine from the list, and then click **Next**.

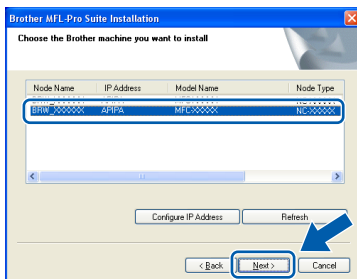

📝 Note

This window will not appear if there is only one machine connected on the network as it will be chosen automatically.

21 When the Brother and ScanSoft on-line Registration screen is displayed, make your selection and follow the on-screen instructions.

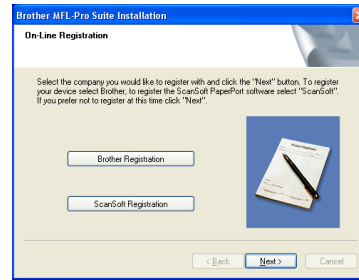

22 Click **Finish** to restart your computer. (For Windows® 2000 Professional/XP, you must be logged on with Administrator rights.)

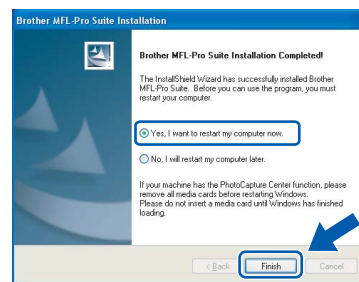

📝 Note

After restarting the computer, the Installation Diagnostics will run automatically. If the installation is unsuccessful, the installation results window will be shown. If the Diagnostics shows a failure please follow the on-screen instruction or read on-line help and FAQ's in Start/All Programs/ Brother/MFL-Pro Suite MFC-XXXX.



The MFL-Pro Suite including Brother Network Printer driver, Network Scanner driver and Network PhotoCapture Center™ have been installed and the installation is now complete.

For USB Interface Users

For Mac OS® X 10.2.4 or greater

Important

Make sure that you have finished the instructions from Step 1 *Setting Up the Machine* on page 4-11.



Note

For Mac OS® X 10.2.0 to 10.2.3 users, upgrade to Mac OS® X 10.2.4 or greater. (For the latest information for Mac OS® X, visit <http://solutions.brother.com>)

- 1 Unplug the machine from the AC outlet and from your computer, if you already connected an interface cable.

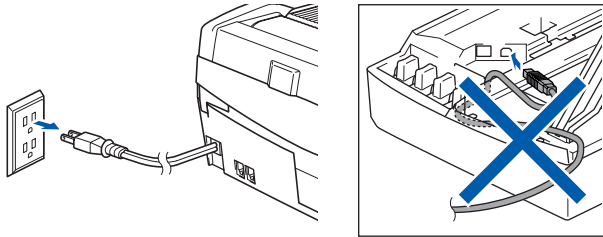

- 2 Turn on your Macintosh®.
- 3 Put the supplied CD-ROM into your CD-ROM drive.
- 4 Double-click the **Start Here OSX** icon to install the drivers and MFL-Pro Suite. If the language screen appears, choose your language.



- 5 Click **MFL-Pro Suite** to install.

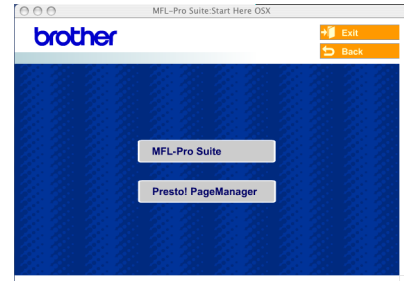

- 6 Choose **Local Connection**, and then click **Next**. Follow the on-screen instructions, and restart your Macintosh®.

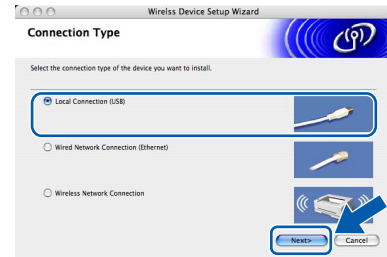

- 7 After the DeviceSelector window appears connect the USB interface cable to your Macintosh and then to the machine. The DeviceSelector window will not appear if you have connected a USB interface cable to the machine before restarting your Macintosh® or if you are overwriting a previously installed version of the Brother Software. If you encounter this problem continue with the installation but skip step 13. After the software installation is completed you should select your Brother machine from the Model pop-up menu in the main screen of ControlCenter2. For details, see chapter 10 in the *Software User's Guide on the CD-ROM*.



8 Open the scanner cover to its open position.

9 Connect the USB cable to the USB socket marked with a  symbol. You will find the USB socket above and to the left of the ink cartridge slots, as shown below.

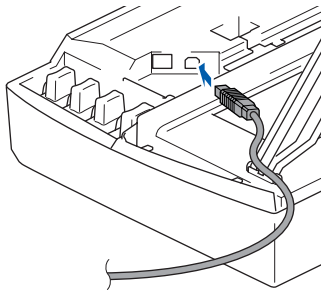

10 Carefully route the USB cable through the trench and out the back of the machine as shown below.

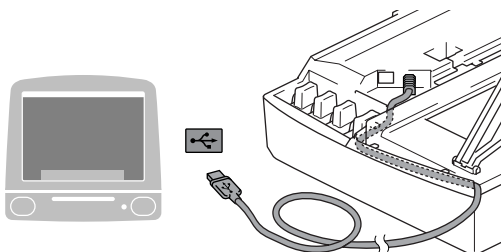

⊘ Improper Setup

- **DO NOT** connect the machine to a USB port on a keyboard or a non-powered USB hub. Brother recommends that you connect the machine directly to your computer.
- **Make sure** that the cable does not restrict the cover from closing, or an error may occur.

11 Lift the scanner cover to release the lock. Gently push the scanner cover support down and close the scanner cover.

12 Turn on the machine by plugging in the power cord.

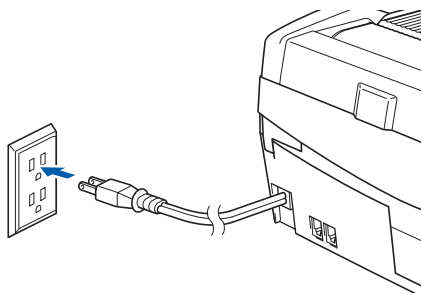

13 Choose **USB** and then click **OK**.

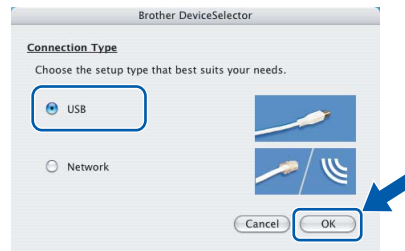

14 Click **GO**, then **Applications**.

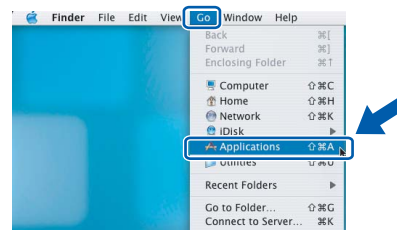

15 Double-click the **Utilities** folder.

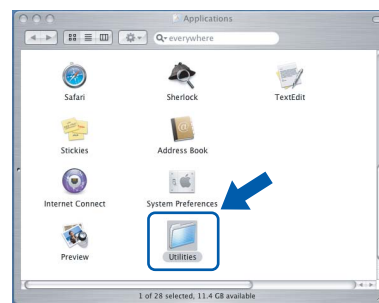

16 Double-click the **Printer Setup Utility** icon.



Note

For Mac® OS X 10.2.x users, open **Print Center** icon.

17 Click **Add**.

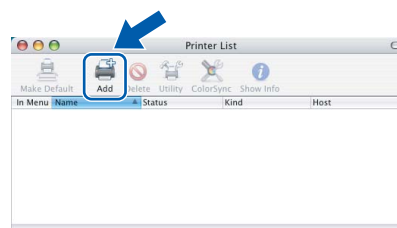

18 Choose **USB**. (For Mac® OS X 10.2.4 to 10.3 users)

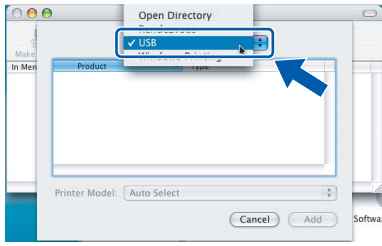

Note

For Mac® OS X 10.4 users, go to step **19**.

19 Choose **MFC-XXXX** (where XXXX is your model name), and then click **Add**.

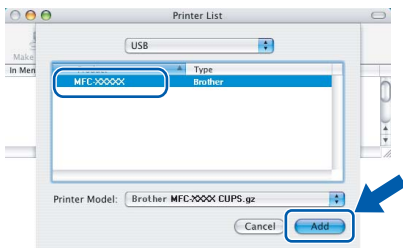

20 Click **Printer Setup Utility**, then **Quit Printer Setup Utility**.

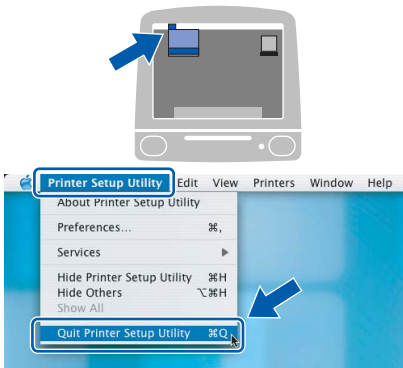

OK!

The MFL-Pro Suite, Brother printer driver, scanner driver and Brother ControlCenter2 have been installed and the installation is now complete.

21 To install Presto!®PageManager®, click the **Presto! PageManager** icon and follow the on-screen instructions.

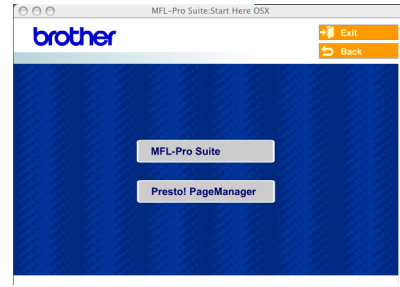

Note

When Presto!®PageManager® is installed OCR capability is added to the Brother ControlCenter2. You can easily scan, share and organize photos and documents using Presto!® PageManager®.

OK!

Presto!® PageManager® has been installed and the installation is now complete.

For Mac OS® 9.1 to 9.2

Important

Make sure that you have finished the instructions from Step 1 *Setting Up the Machine* on page 4-11.

- 1 Unplug the machine from the AC outlet and from your computer, if you already connected an interface cable.

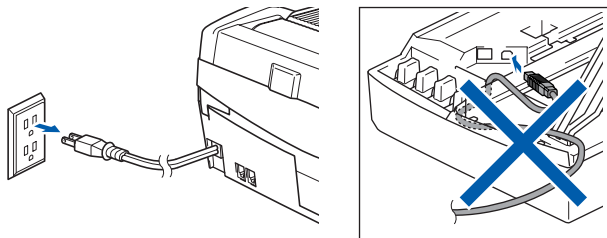

- 2 Turn on your Macintosh®.

- 3 Put the supplied CD-ROM into your CD-ROM drive.



- 4 Double-click the **Start Here OS 9.1-9.2** icon to install the printer and scanner drivers. If the language screen appears, choose your language.

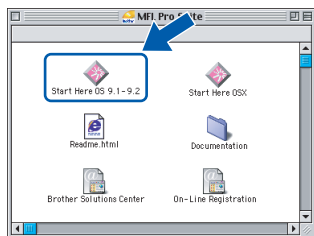

- 5 Click **MFL-Pro Suite** to install.



- 6 Follow the on-screen instructions, and restart your Macintosh®.

- 7 Open the scanner cover to its open position.

- 8 Connect the USB cable to the USB socket marked with a  symbol. You will find the USB socket above and to the left of the ink cartridge slots, as shown below.

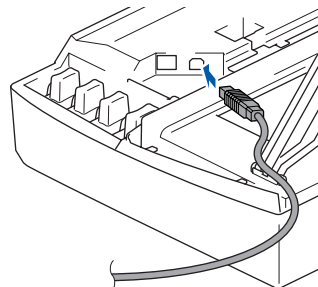

- 9 Carefully route the USB cable through the trench and out the back of the machine as shown below. Then, connect it to your Macintosh®.

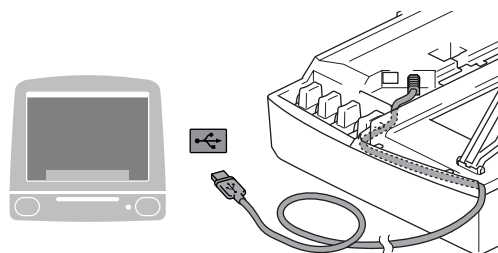

⊘ Improper Setup

- **DO NOT** connect the machine to a USB port on a keyboard or a non-powered USB hub. Brother recommends that you connect the machine directly to your computer.
- **Make sure** that the cable does not restrict the cover from closing, or an error may occur.

- 10 Lift the scanner cover to release the lock. Gently push the scanner cover support down and close the scanner cover.

- 11 Turn on the machine by plugging in the power cord.

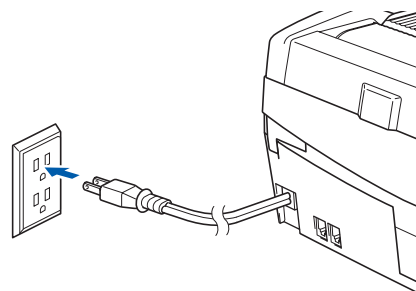

12 From the Apple® menu, click **Chooser**.

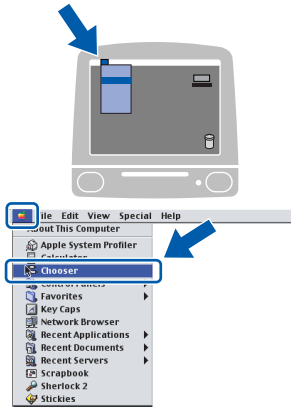

13 Click the **Brother Ink** icon.
On the right side of the **Chooser**, choose the machine to which you want to print.
Close the **Chooser**.

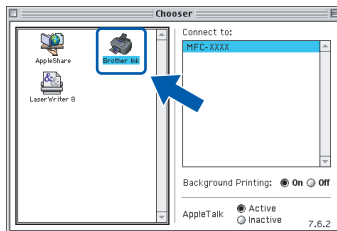

OK! The **Brother printer driver and scanner driver have been installed.**

Note

ControlCenter2 is not supported in Mac OS® 9.x.

14 To install Presto!® PageManager®, click the **Presto! PageManager** icon and follow the on-screen instructions.



Note

You can easily scan, share and organize photos and documents using Presto!® PageManager®.

OK! **Presto!® PageManager® has been installed and the installation is now complete.**

For Wired Network Interface Users

For Mac OS® X 10.2.4 or greater

Important

Make sure that you have finished the instructions from **Step 1 Setting Up the Machine** on page 4-11.

- 1 Unplug the machine from the AC outlet.

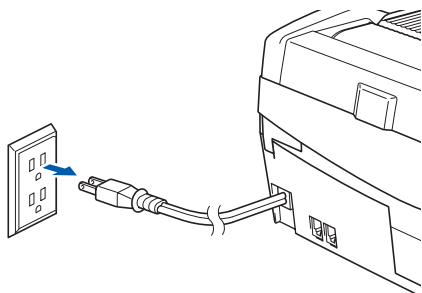

- 2 Turn on your Macintosh®.
- 3 Put the supplied CD-ROM into your CD-ROM drive.



- 4 Double-click the **Start Here OSX** icon to install the drivers and MFL-Pro Suite. If the language screen appears, choose your language.

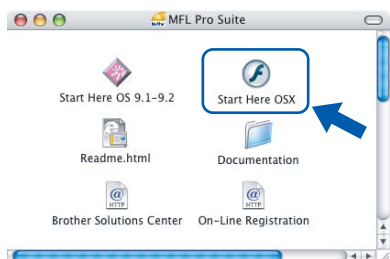

- 5 Click **MFL-Pro Suite** to install.

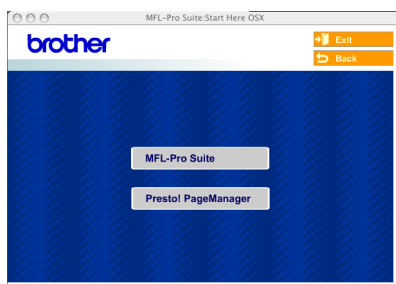

- 6 Choose **Wired Network Connection**, and then click **Next**. Follow the on-screen instructions, and restart your Macintosh®.

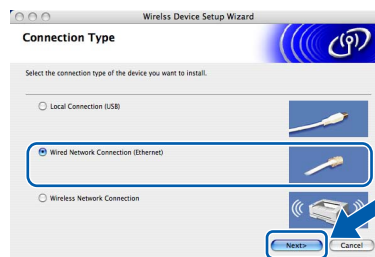

- 7 After the DeviceSelector window appears, connect the network interface cable to your Macintosh® and then to the machine.

The DeviceSelector window will not appear if you have also connected a USB interface cable to the machine before restarting your Macintosh® or if you are overwriting a previously installed version of the Brother Software. If you encounter this problem continue but skip steps **13** to **16**. After the software installation is completed you should choose your Brother machine from the Model pull-down list in the main screen of ControlCenter2. For details, see Chapter 10 in the Software User's Guide on the CD-ROM.



- 8 Open the scanner cover to its open position.
- 9 Connect the network cable to the LAN socket marked with a  symbol. You will find the LAN socket above and to the left of the ink cartridge slots, as shown below.

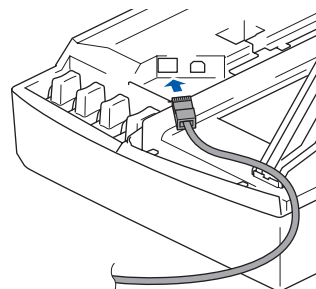

- 10** Carefully route the network cable through the trench and out the back of the machine as shown below. Then, connect the cable to your network.

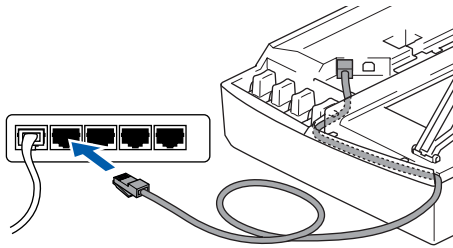

Improper Setup

Make sure that the cable does not restrict the cover from closing, or an error may occur.

Note

In case of using both USB and LAN cables, route both cables into the trench with one on top of the other.

- 11** Lift the scanner cover to release the lock. Gently push the scanner cover support down and close the scanner cover.
- 12** Turn on the machine by plugging in the power cord.

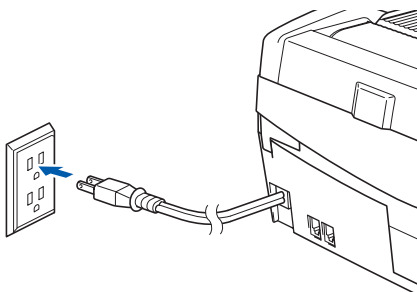

Improper Setup

If you have setup wireless networking on your machine before and you setup the wired network, you should check that the machine's Network I/F setting is set to wired LAN. The wireless network interface will be inactive with this setting.

Press Menu/Set, 5, 6, and then press ▲ or ▼ to choose wired LAN. Press Menu/Set and then press 1. Yes to accept the change. The machine will restart automatically.

- 13** Choose **Network** and then click **OK**.

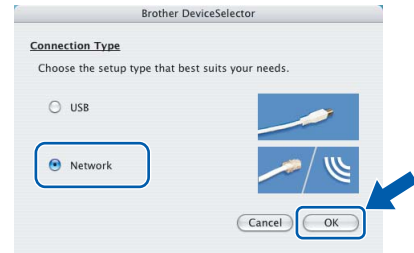

- 14** If you want to use the machine's **Scan** key to scan over the network you must check the **Register your computer with the "Scan To" functions at the machine box**. You must also enter a name for your Macintosh® in **Display Name**. The name you enter will appear on the machine's LCD when you press the **Scan** key and choose a scan option. You can enter any name up to 15 characters long. (For more information on network scanning, see Chapter 11 of the Software User's Guide on the CD-ROM.)



- 15** Click **Browse**.

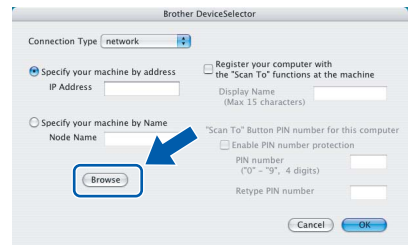

- 16** Choose your model name, and then click **OK**.

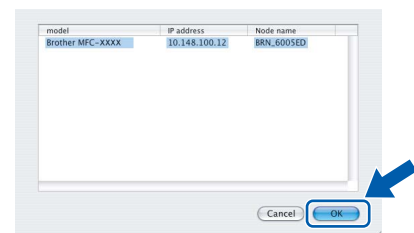

- 17** Click **Go**, then **Applications**.

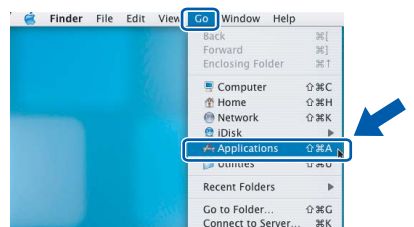

18 Double-click the **Utilities** folder.

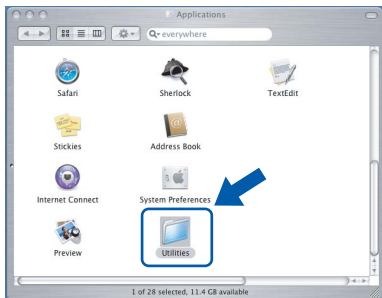

19 Double-click the **Printer Setup Utility** icon.

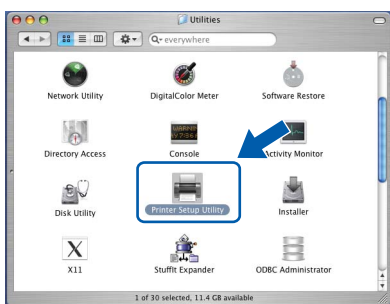

Note

For Mac® OS X 10.2.x users, open **Print Center** icon.

20 Click **Add**.

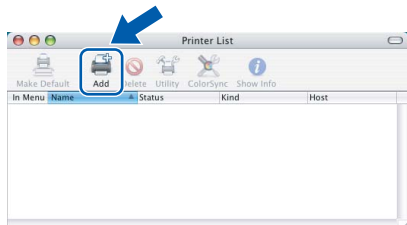

21 Make the selection shown below. (For Mac® OS X 10.2.4 to 10.3 users)

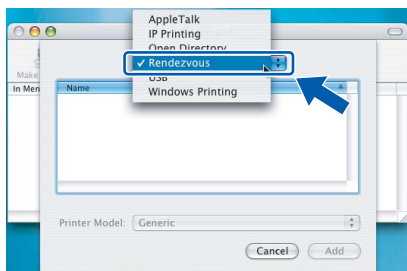

Note

For Mac® OS X 10.4 users, go to step **22**.

22 Choose **Brother MFC-XXXX** (where XXXX is your model name), and then click **Add**.

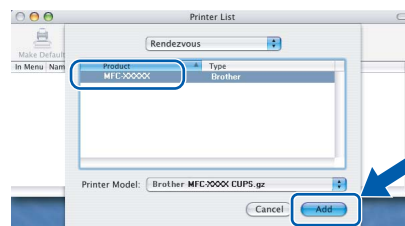

23 Click **Printer Setup Utility**, then **Quit Printer Setup Utility**.

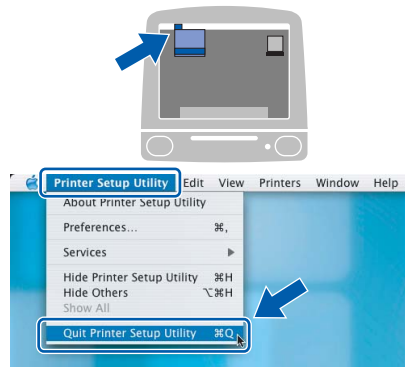

The **MFL-Pro Suite, Printer Driver, Scanner Driver and ControlCenter2** have been installed.



For more information about connecting the machine to a Macintosh® network, see Chapter 6 of the Network User's Guide on the CD-ROM.

24 To install Presto!®PageManager®, click the **Presto! PageManager** icon and follow the on-screen instructions.

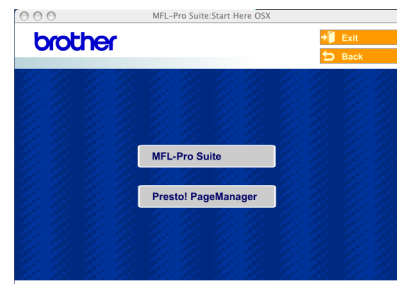

Note

When **Presto!®PageManager®** is installed OCR capability is added to the **Brother ControlCenter2**. You can also easily scan, share, and organize photos and documents using **Presto!®PageManager®**.



Presto!®PageManager® has been installed and the installation is now complete.

For Mac OS® 9.1 to 9.2

Important

Make sure that you have finished the instructions from Step 1 *Setting Up the Machine* on page 4-11.

- 1** Unplug the machine from the AC outlet.

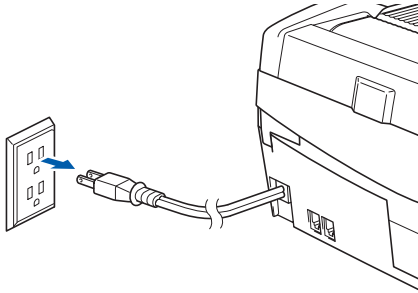

- 2** Turn on your Macintosh®.

- 3** Put the supplied CD-ROM into your CD-ROM drive.



- 4** Double-click the **Start Here OS 9.1-9.2** icon to install the printer and scanner drivers. If the language screen appears, choose your language.

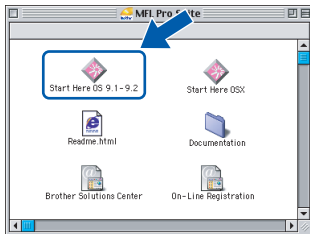

- 5** Click **MFL-Pro Suite** to install.



- 6** Follow the on-screen instructions, and restart your Macintosh®.

- 7** Open the scanner cover to its open position.

- 8** Connect the network cable to the LAN socket marked with a  symbol. You will find the LAN socket above and to the left of the ink cartridge slots, as shown below.

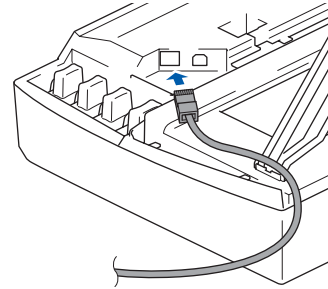

- 9** Carefully route the network cable through the trench and out the back of the machine as shown below. Then, connect the cable to your network.

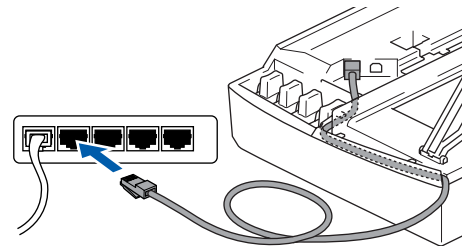
**Improper Setup**

Make sure that the cable does not restrict the cover from closing, or an error may occur.

Note

In case of using both USB and LAN cables, route both cables into the trench with one on top of the other.

- 10** Lift the scanner cover to release the lock. Gently push the scanner cover support down and close the scanner cover.

- 11** Turn on the machine by plugging in the power cord.

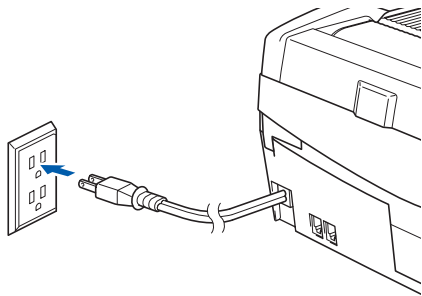

⊘ Improper Setup

If you have setup wireless networking on your machine before and you setup the wired network, you should check that the machine's **Network I/F** setting is set to **wired LAN**. The wireless network interface will be inactive with this setting.

Press **Menu/Set**, **5**, **6**, and then press **▲** or **▼** to choose **wired LAN**. Press **Menu/Set** and then press **1 1**. **Yes** to accept the change. The machine will restart automatically.

- 12** From the **Apple®** menu, click **Chooser**.

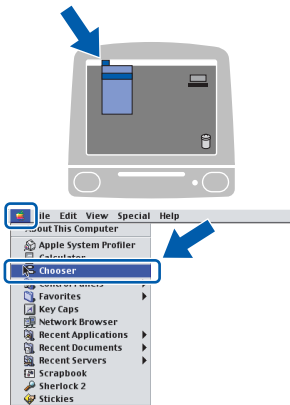

- 13** Click the **Brother Ink (IP)** icon, and then choose **BRN_XXXXXX** (where XXXXXX are the last six digits of the Ethernet address). Close the **Chooser**.

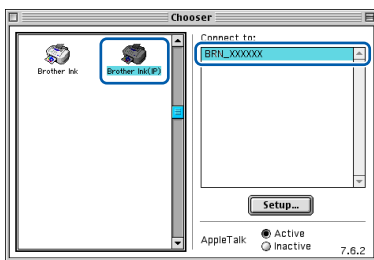

For more information about connecting the machine to a Macintosh® network, see Chapter 6 of the Network User's Guide on the CD-ROM.



The **MFL-Pro Suite, Printer Driver and Scanner Driver** have been installed.



Note

ControlCenter2 is not supported in Mac OS® 9.x.

- 14** To install **Presto!®PageManager®**, click the **Presto! PageManager** icon and follow the on-screen instructions.



Note

You can easily scan, share, and organize photos and documents using Presto!®PageManager®.



Presto!®PageManager® has been installed and the installation is now complete.

For Wireless Network Users

For Mac OS® X 10.2.4 or greater in infrastructure mode

Important

Make sure that you have finished the instructions from Step 1 *Setting Up the Machine* on page 4-11.

These instructions will install your Brother machine in a typical small office or home wireless network environment in infrastructure mode, using a wireless router or access point that uses DHCP to assign IP addresses. If you want to setup your machine in any other wireless environment you can find instructions in the Network User's Guide on the CD-ROM. You can view the Network User's Guide by following the instructions below.

- 1 Turn on your Macintosh®. Insert the Brother CD-ROM labeled Macintosh® into your CD-ROM drive.
- 2 Double-click the **Documentation** icon.
- 3 Double-click your language folder.
- 4 Double-click the Network User's Guide BH3eWLAN_UsaEngNet.pdf.

To achieve optimum results with normal every day document printing, place the Brother machine as close to the network access point (router) as possible with minimal obstructions. Large objects and walls between the two devices as well as interference from other electronic devices can affect the data transfer speed of your documents.

Due to these factors, wireless may not be the best method of connection for all types of documents and applications. If you are printing large files, such as photos on glossy paper or multi-page documents with mixed text and large graphics, you may want to consider choosing wired Ethernet for a faster data transfer, or USB for the fastest throughput speed.

First you must configure the wireless network settings of your machine to communicate with your network access point (router). After the machine is configured to communicate with your access point computers on your network will have access to the machine. To use the machine from these computers, you will need to install the MFL-Pro Software Suite. The following steps will guide you through the configuration and installation process.



- 1 Write down the wireless network settings of your access point or wireless router.

SSID (Service Set ID or Network name)

WEP Key (if needed)

WPA-PSK (TKIP) (if needed)

The WEP key is for 64bit encrypted networks or 128 bit encrypted networks and can contain both numbers and letters. If you do not know this information you should see the documentation provided with your access point or wireless router. This key is a 64-bit or 128-bit value that must be entered in an ASCII or HEXADECIMAL format.

For example:

- | | |
|----------------------|---|
| 64 bit ASCII: | Uses 5 text characters.
e.g. "Hello" (this is case sensitive) |
| 64 bit Hexadecimal: | Uses 10 digits of hexadecimal data.
e.g. "71f2234aba" |
| 128 bit ASCII: | Uses 13 text characters.
e.g. "Wirelesscomms" (this is case sensitive) |
| 128 bit Hexadecimal: | Uses 26 digits of hexadecimal data.
e.g. "71f2234ab56cd709e5412aa3ba" |

WPA-PSK enables a Protected Access Pre-shared key that allows the Brother wireless machine to associate with access points using TKIP encryption. WPA-PSK uses a Pre-Shared Key that is more than 7 and less than 64 characters in length.



Note

Your machine supports WEP and WPA-PSK(TKIP). WPA-PSK(AES) is not supported.

See Chapter 3 of the Network User's Guide for more details.

- 2** Turn on the machine by plugging in the power cord.

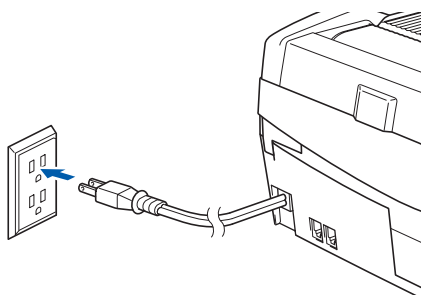

No Authentication with WEP Encryption: Choose *Open system*, press **Menu/Set** then use the **▲** or **▼** to choose *WEP* for the *Encryption Type* and press **Menu/Set**. Go to step **7**.

Authentication with WEP Encryption: Choose *Shared Key*, press **Menu/Set**. Go to step **7**.

Authentication with WPA-PSK (TKIP) Encryption: Choose *WPA-PSK*, press **Menu/Set**. Go to step **8**.

⊘ Improper Setup

If you have previously configured the wireless settings of the machine you must reset the network (LAN) settings before you can configure the wireless settings again. Press **Menu/Set**, **5**, **0**, **1** and then press **1 1**. **Yes** to accept the change. The machine will restart automatically.

- 3** On your machine, press **Menu/Set**, **5**, **6**, then press **▲** or **▼** to choose *WLAN*, then press **Menu/Set**. Press **1 1**. **Yes** to reboot the machine. The wired network interface will become inactive with this setting.

It will take about a minute for the LAN menu on the LCD to become available again.

A four level indicator on the right of your machine's LCD shows the wireless signal strength.

- 4** When the LAN menu becomes available, press **Menu/Set**, **5**, **3**, **1** to start the wireless setup wizard.

- 5** The machine will search for your network and display a list of available SSIDs. You should see the SSID you wrote down earlier. If the machine finds more than one network use the **▲** or **▼** keys to choose your network, then press **Menu/Set**.

- 6** Use the **▲**, **▼** and **Menu/Set** keys to choose one of the options below: If your network is configured for Authentication and Encryption you must match the settings used for your network.

No Authentication or Encryption: Choose *Open system*, press **Menu/Set** then choose *None* for *Encryption Type* and press **Menu/Set**. Then press **1 1**. **Yes** to apply your settings. Go to step **9**.

- 7** Choose the appropriate key number and press **Menu/Set**. Enter the WEP key you wrote down in step **1** using the dial pad. You can use the **◀** and **▶** keys to move the cursor. For example, to enter the letter *a*, press the **1** key on the dial pad once. To enter the number *3*, press the **3** key on the dial pad seven times. The letters appear in this order: lower case, upper case, numbers and then special letters.

Press **Menu/Set** when you have entered all the characters, then press **1 1**. **Yes** to apply your settings. Go to step **9**.

Most access points and routers can store more than one key, but they will only use one at any time for authentication and encryption.

- 8** Enter the WPA-PSK (TKIP) key *WPA* you wrote down in step **1** using the dial pad. You can use the **◀** and **▶** keys to move the cursor. For example, to enter the letter *a*, press the **1** key on the dial pad once. To enter the number *3*, press the **3** key on your dial pad seven times. Press **Menu/Set** when you have entered all the characters, then press **1 1**. **Yes** to apply your settings. Go to step **9**.

- 9** Your machine will now try to connect to your wireless network using the information you have entered. If successful, *Connected* will appear briefly on the LCD.

*If your machine does not successfully connect to your network, you should repeat steps **3** to **8** to make sure you have entered the correct information.*

10 Disconnect and then reconnect the power cord to turn the machine OFF and back ON. This will allow the machine to automatically acquire the correct TCP/IP address information from your access point (router) if DHCP is enabled (DHCP is normally enabled as default for most access point routers).

If your access point does not have DHCP enabled you will need to manually configure the IP address, subnet mask and gateway of the machine to suit your network. See the Network User's Guide for details.

OK! Wireless setup is now complete. To install the MFL-Pro Software suite, continue to step 11.

11 Turn on your Macintosh®.

12 Put the supplied CD-ROM into your CD-ROM drive.



13 Double-click the **Start Here OSX** icon to install the drivers and MFL-Pro Suite. If the language screen appears, choose your language.



14 Click **MFL-Pro Suite** to install.



15 Choose **Wireless Network Connection**, and then click **Next**.

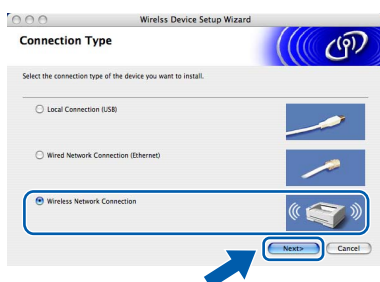

16 Choose **Driver Install only**, and then click **Next**.

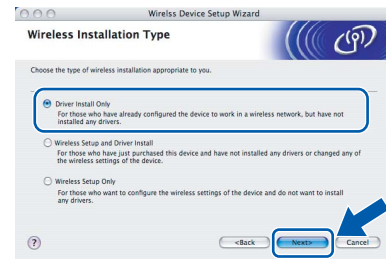

17 Follow the on-screen instructions and restart your Macintosh®.

18 When the DeviceSelector window appears choose **Network** and then click **OK**. The DeviceSelector window will not appear if you have also connected a USB interface cable to the machine before restarting your Macintosh or if you are overwriting a previously installed version of the Brother Software. If you encounter this problem continue but skip steps 19 through 21. After the software installation is completed you should choose your Brother machine from the Model pop-up menu in the main screen of ControlCenter2. For details, see Chapter 10 in the Software User's Guide on the CD-ROM.

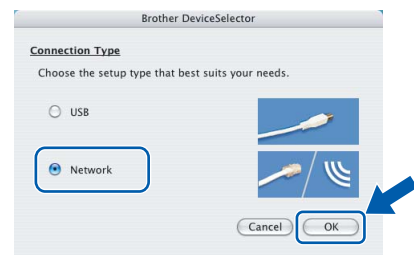

19 If you want to use the machine's **Scan** key to scan over the network you must check the **Register your computer with the "Scan To" functions at the machine** box. You must also enter a name for your Macintosh® in **Display Name**. The name you enter will appear on the machine's LCD when you press the **Scan** key and choose a scan option. You can enter any name up to 15 characters long. (For more information on network scanning, see Chapter 11 of the Software User's Guide on the CD-ROM.)

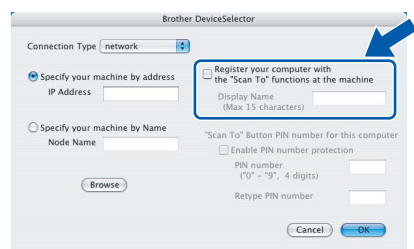

20 Click **Browse**.

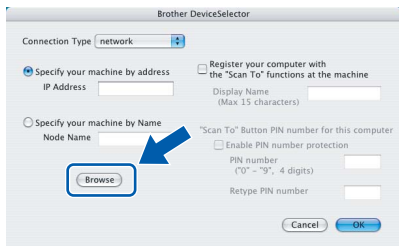

21 Choose your model name, and then click **OK**.

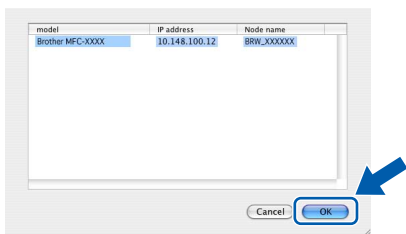

22 Click **Go**, then **Applications**.

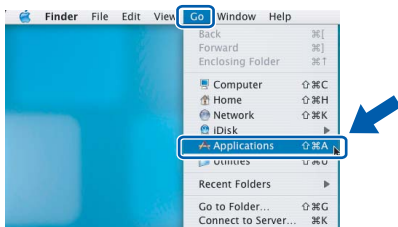

23 Double-click the **Utilities** folder.

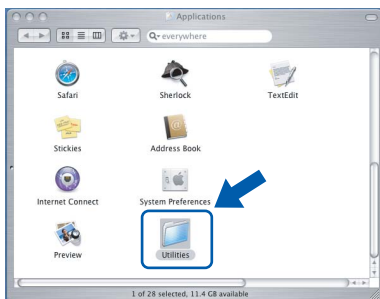

24 Double-click the **Printer Setup Utility** icon.



Note
For Mac® OS X 10.2.x users, open **Print Center**.

25 Click **Add**.

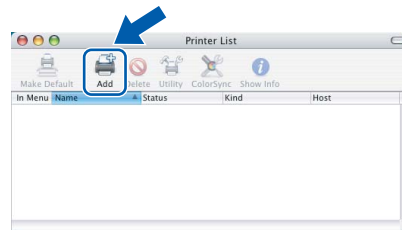

26 Make the selection shown below. (For Mac® OS X 10.2.4 to 10.3 users)

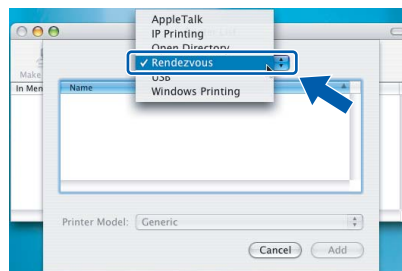

Note
For Mac® OS X 10.4 users, go to step **27**.

27 Choose **Brother MFC-XXXX** (where XXXX is your model name), and then click **Add**.

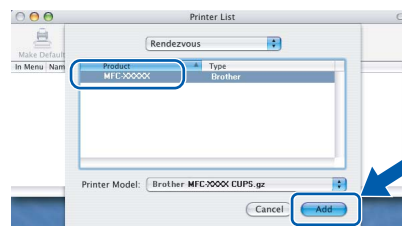

Note
See Chapter 6 of the Network User's Guide on the CD-ROM.

28 Click **Printer Setup Utility**, then **Quit Printer Setup Utility**.

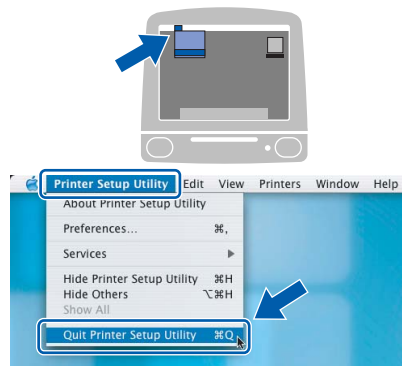

OK! The MFL-Pro Suite, Printer Driver, Scanner Driver and ControlCenter2 have been installed.



For more information about connecting the machine to a Macintosh® network, see Chapter 6 of the Network User's Guide on the CD-ROM.

- 29** To install Presto!®PageManager®, click the **Presto!PageManager** icon and follow the on-screen instructions.

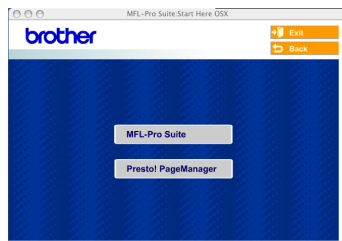

Note

When Presto!®PageManager® is installed OCR capability is added to the Brother ControlCenter2. You can also easily scan, share, and organize photos and documents using Presto!®PageManager®.



Presto!® PageManager® has been installed and the installation is now complete.

This section explains how you can configure network settings using the BRAdmin Professional Utility or how to set the machine's network settings to wireless LAN or wired LAN.

Installing the BRAdmin Professional configuration utility

The BRAdmin Professional utility for Windows® is designed to manage your Brother network connected devices such as network-ready Multifunction devices and/or network-ready printers in a Local Area Network (LAN) environment.

For Macintosh® users, please visit the Brother Solutions Center (<http://solutions.brother.com>) to download BRAdmin Light for Macintosh®. BRAdmin Professional can also be used to manage devices from other manufacturers whose products support SNMP (Simple Network Management Protocol).

For more information on BRAdmin Professional and BRAdmin Light, visit <http://solutions.brother.com>

For Windows® users

- 1 Put the supplied CD-ROM into your CD-ROM drive. The opening screen will appear automatically. Follow the on-screen instructions.



- 2 Click **Install Optional Applications** on the main menu screen.

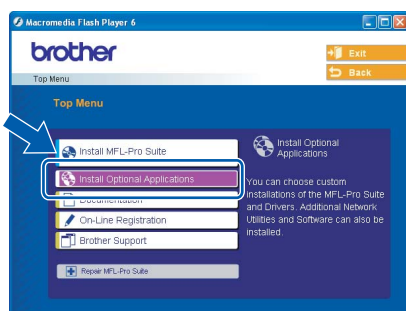

- 3 Click **BRAdmin Professional** and follow the on-screen instructions.

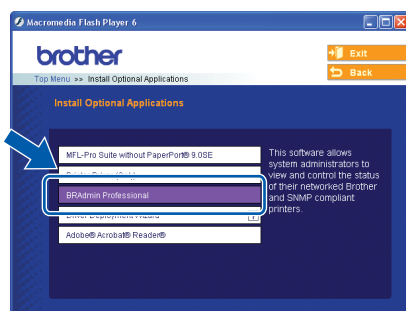

Setting your IP address, Subnet Mask and Gateway using BRAdmin Professional (For Windows® users)

- 1 Start BRAdmin Professional, and choose **TCP/IP**.

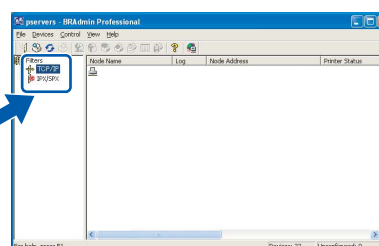

- 2 Click **Devices**, then **Search Active Devices**. BRAdmin searches for new devices automatically.

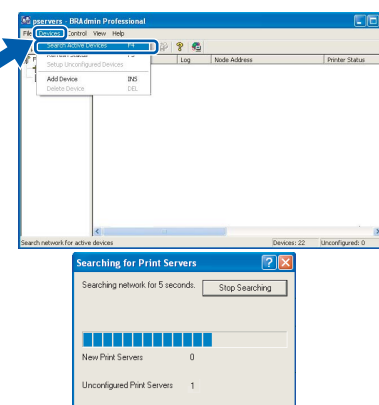

- 3 Double-click the new device.

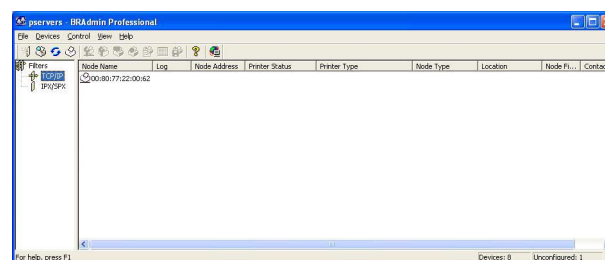

- 4 Enter the **IP Address, Subnet Mask and Gateway**, and then click **OK**.

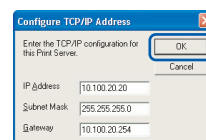

- 5 The address information will be saved to the machine.

Note

You can use the BRAdmin Professional utility to set a password. (See the Network User's Guide on the CD-ROM.)

How to set the machine's network settings to wireless LAN or wired LAN

To connect your Brother machine to a wireless or wired network you must configure the machine from the machine's control panel for the network type you are using.

For wireless LAN

On your machine, press **Menu/Set, 5, 6** then press **▲** or **▼** to choose *WLAN*, and then press **Menu/Set**. Press **1 1 . Yes** to reboot the machine. The wired network interface will become inactive with this setting.

It will take about a minute for the LAN menu on the LCD to become available again.

For wired LAN

On your machine, press **Menu/Set, 5, 6** then press **▲** or **▼** to choose *Wired LAN*, and then press **Menu/Set**. Press **1 1 . Yes** to reboot the machine. The wireless network interface will become inactive with this setting.

It will take about a minute for the LAN menu on the LCD to become available again.

Replacement consumables

When the time comes to replace ink cartridges, an error message will be indicated on the LCD. For more information about the ink cartridges for your machine, visit <http://solutions.brother.com> or contact your local Brother re-seller.

Ink cartridge

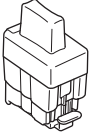
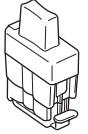
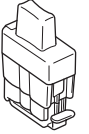
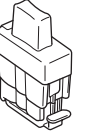
Black	Magenta	Yellow	Cyan
LC41BK	LC41M	LC41Y	LC41C
			

Trademarks

The Brother logo is a registered trademark of Brother Industries, Ltd.

Brother is a registered trademark of Brother Industries, Ltd.

Multi-Function Link is a registered trademark of Brother International Corporation.

Windows and Microsoft are registered trademarks of Microsoft in the U.S. and other countries.

Macintosh and True Type are registered trademarks of Apple Computer, Inc.

PaperPort and OmniPage OCR are registered trademarks of ScanSoft, Inc.

Presto! PageManager is a registered trademark of NewSoft Technology Corporation.

BROADCOM, SecureEasySetup, and the SecureEasySetup logo are trademarks or registered trademarks of Broadcom Corporation in the United States and/or other countries.

Each company whose software title is mentioned in this manual has a Software License Agreement specific to its proprietary programs.

All other brand and product names mentioned in this manual are trademarks or registered trademarks of their respective companies.

Compilation and Publication

Under the supervision of Brother Industries Ltd., this manual has been compiled and published, covering the latest product descriptions and specifications.

The contents of this manual and the specifications of this product are subject to change without notice.

Brother reserves the right to make changes without notice in the specifications and materials contained herein and shall not be responsible for any damages (including consequential) caused by reliance on the materials presented, including but not limited to typographical and other errors relating to the publication.

This product is designed for use in a Professional Environment.

brother®

USA/CAN