

Before you can use the machine, please read this Quick Setup Guide for the correct setup and installation. To view the Quick Setup Guide in other languages, please visit <http://solutions.brother.com/>.



! IMPORTANT

DO NOT connect the interface cable yet.

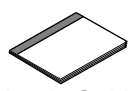
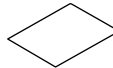

1

Unpack the machine and check the components

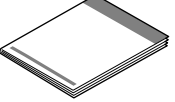
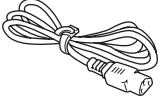
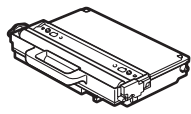
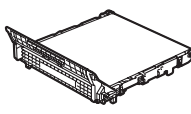
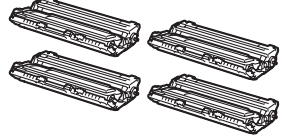
	 User's Guide	 Accessory Order Form	 Product Registration Sheet (USA only)
 CD-ROM (Windows®) (Macintosh)	 Quick Setup Guide	 AC Power Cord	
 Waste Toner Box (pre-installed)	 Belt Unit (pre-installed)	 Drum Unit and Starter Toner Cartridge Assemblies (Black, Cyan, Magenta and Yellow)	

! WARNING

- Plastic bags are used in the packaging of your machine. To avoid danger of suffocation, please keep these bags away from babies and children.
- This machine is heavy and weighs approximately 50.0 lb. (22.7 kg). To prevent injuries use at least two people to lift the machine. Be careful not to pinch your fingers when you put the machine back down.

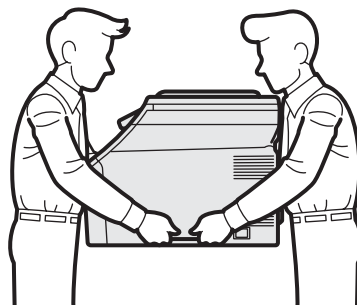

 **Note**

Keep a minimum gap around the machine as shown in the illustration.

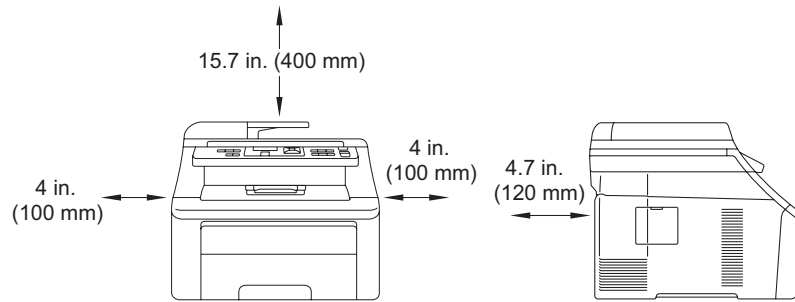

 **Note**

- The components included in the box may differ depending on your country.
- Save all packing materials and the box in case for any reason you must ship your machine.
- The interface cable is not a standard accessory. Buy the appropriate interface cable for the interface you want to use (USB or Network).





USB cable

- Please make sure you use a USB 2.0 cable (Type A/B) that is no longer than 6 feet (2 meters).
- DO NOT connect the interface cable at this time. Connecting the interface cable is done during MFL-Pro installation process.
- When you use a USB cable, make sure you connect it to the USB port of your computer and not to a USB port on a keyboard or non-powered USB hub.

Network cable

Use a straight-through Category 5 (or greater) twisted-pair cable for 10BASE-T or 100BASE-TX Fast Ethernet Network.

Symbols used in this guide

 WARNING	WARNINGS tell you what to do to prevent possible personal injury.
 CAUTION	CAUTIONS specify procedures you must follow or avoid to prevent possible minor injuries.
 IMPORTANT	IMPORTANT specifies procedures you must follow or avoid to prevent possible damage to the machine or other objects.
 Note	Notes tell you how you should respond to a situation that may arise or give tips about how the current operation works with other features.
 User's Guide Network User's Guide	Indicates reference to the User's Guide or Network User's Guide which is on the CD-ROM we have supplied.

2 Remove the packing material from the machine

! IMPORTANT

- Save all packing material and the carton in case you have to ship your machine.
- DO NOT plug in the AC power cord yet.

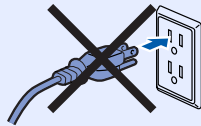

a Remove the packing tape from the outside of the machine.

b Open the top cover by lifting up on the handle ①.

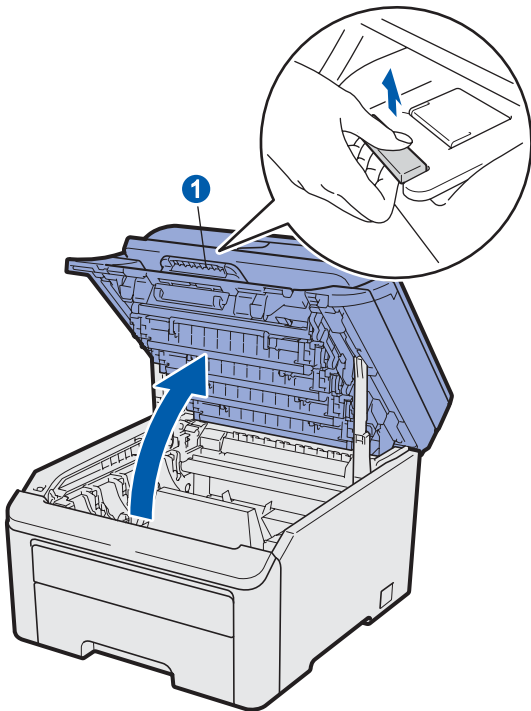

c Remove the packing material from the inside of the machine.

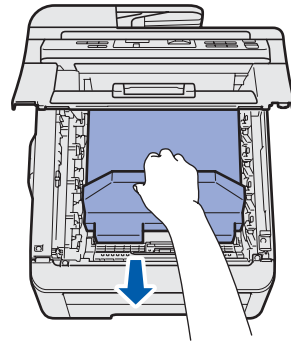

3 Install the drum unit and toner cartridge assemblies

- a** Unpack the four drum unit and toner cartridge assemblies and gently shake each of them from side to side several times to distribute the toner evenly inside the assembly.

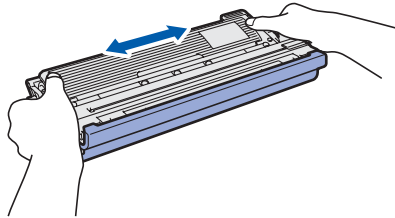

- b** Remove the protective cover by pulling on the tab as shown in the illustration.

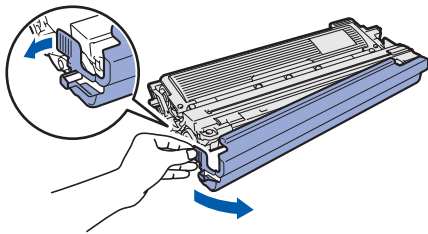

Note

Do not touch the surface of the packing film. It may contain toner powder which can stain your skin and clothing.



! IMPORTANT

To avoid print quality problems, DO NOT touch the surface of the drum unit.

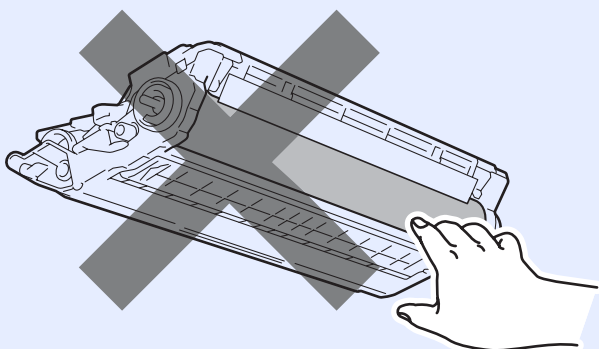

- c** Slide all four of the drum unit and toner cartridge assemblies into the machine as shown in the illustration. Make sure that you match the toner cartridge color to the same color label on the machine.

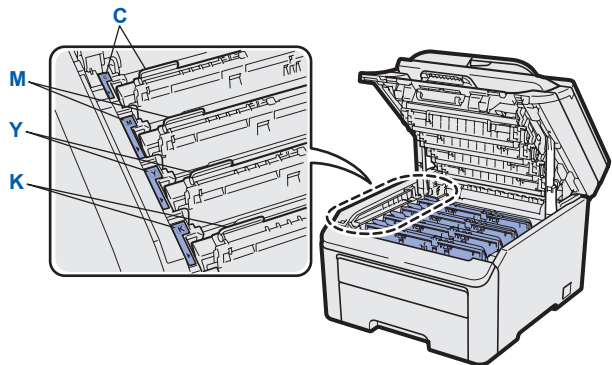
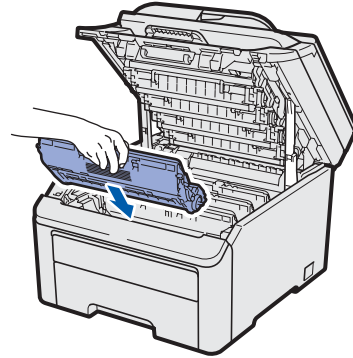

C - Cyan

Y - Yellow

M - Magenta

K - Black

- d** Close the top cover of the machine.

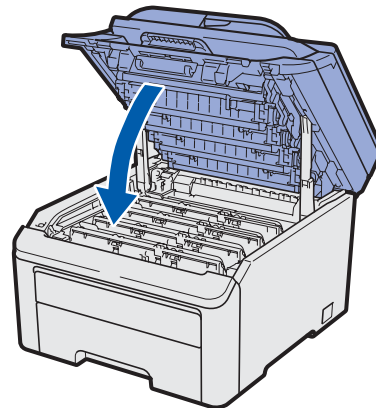

4 Load paper in the paper tray

a Pull the paper tray completely out of the machine.

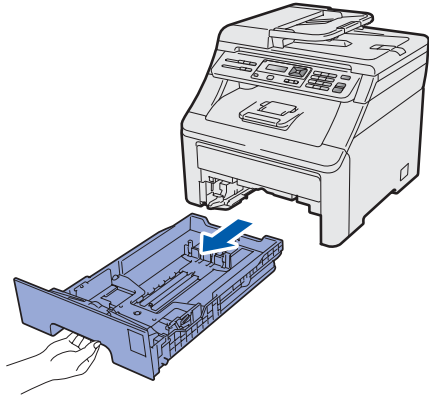

b While pressing the green paper-guide release lever ❶, slide the paper guides to fit the paper size you are loading in the tray. Make sure that the guides are firmly in the slots.

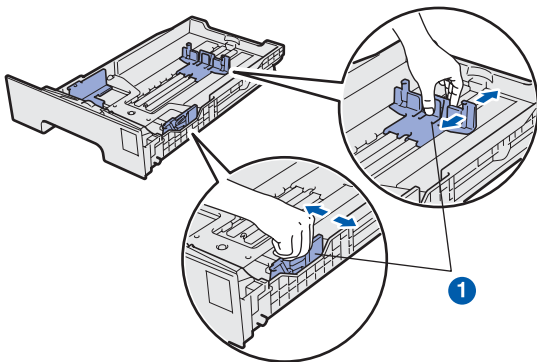

c Fan the stack of paper well to avoid paper jams and misfeeds.

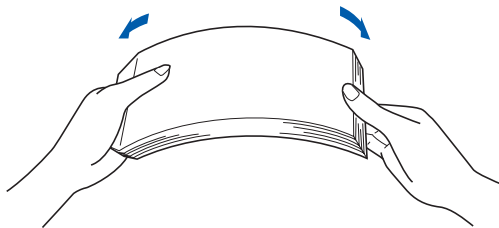

d Put paper in the tray, and make sure that the paper is below the maximum paper mark ❶. The side to be printed on must be face down.

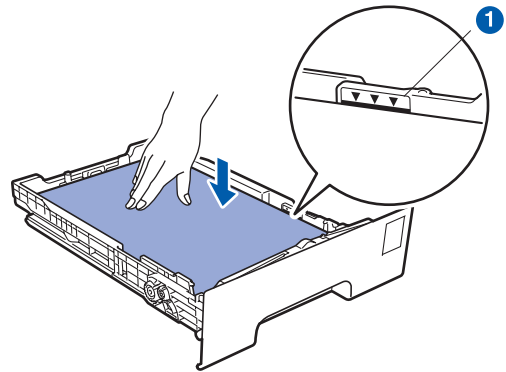

❗ IMPORTANT

Make sure the paper guides touch the sides of the paper so it will feed properly.

e Put the paper tray firmly back in the machine. Make sure that it is completely inserted into the machine.

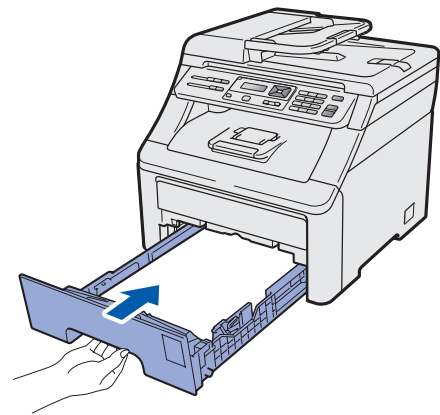

f Unfold the support flap ❶ to prevent paper from sliding off the face-down output tray.

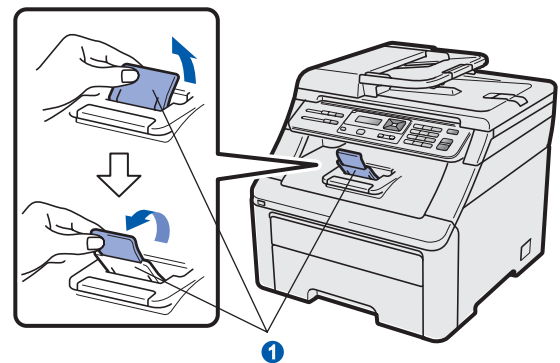

5 Connect the power cord

! IMPORTANT

DO NOT connect the interface cable yet.

- a** Make sure that the machine's power switch is off. Connect the AC power cord to the machine.

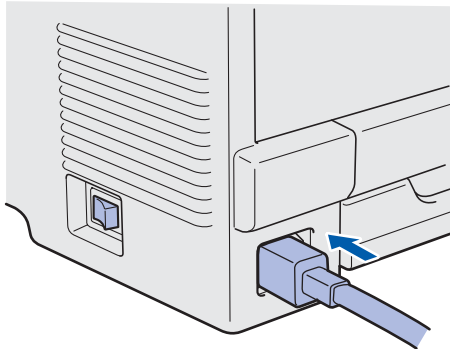

- b** Plug the AC power cord into an AC outlet. Turn the power switch on.

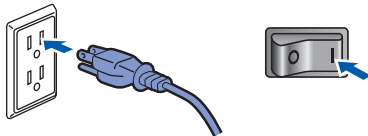

6 Choose your language (if needed)

- a** Press **Menu**, **1**, **0**.

```
General Setup
0. Local Language
```

- b** Press **▲** or **▼** to choose your language.
Press **OK**.

- c** Press **Stop/Exit**.

7

Set the LCD contrast (if needed)

If you are having difficulty reading the LCD, try changing the contrast setting.

- a** Press **Menu**, **1**, **4**.



General Setup
4.LCD Contrast

- b** Press **▲** to increase the contrast.
—OR—
Press **▼** to decrease the contrast.
Press **OK**.

- c** Press **Stop/Exit**.

8

Choose your connection type

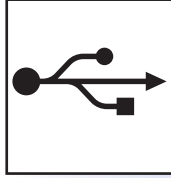
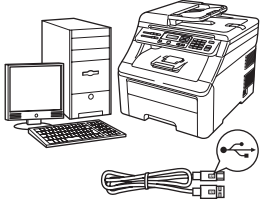

For USB Interface Users

Windows[®], go to page 10
Macintosh, go to page 14

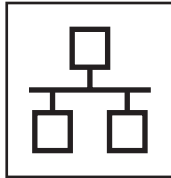
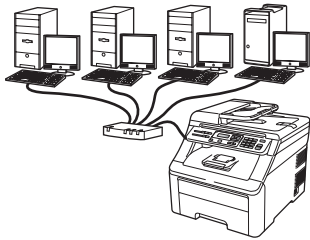

For Wired Network

Windows[®], go to page 16
Macintosh, go to page 21



Note

For Windows Server[®] 2003/ 2008, see the Network User's Guide on the CD-ROM.

USB	Windows [®]
	Macintosh
Wired Network	Windows [®]
	Macintosh



For USB Interface Users (Windows® 2000 Professional/XP/XP Professional x64 Edition/ Windows Vista®)

9 Before you install

- a Make sure that your computer is ON and you are logged on with Administrator rights.

! IMPORTANT

- **DO NOT** connect the USB cable yet.
- If there are any programs running, close them.
- The screen may differ depending on the operating system.
- The supplied CD-ROM includes ScanSoft™ PaperPort™ 11SE. This software supports Windows® 2000 (SP4 or greater), XP (SP2 or greater), XP Professional x64 Edition and Windows Vista®. Update to the latest Windows® Service Pack before installing MFL-Pro Suite.

- b Turn off and unplug the machine from the AC outlet and disconnect it from your computer, if you already connected an interface cable.

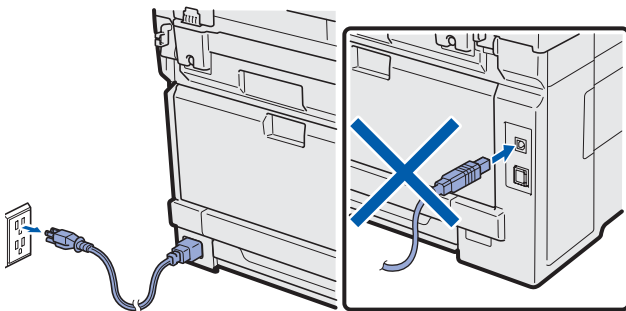

10 Install MFL-Pro Suite

- a Put the supplied CD-ROM into your CD-ROM drive. If the model name screen appears, choose your machine. If the language screen appears, choose your language.

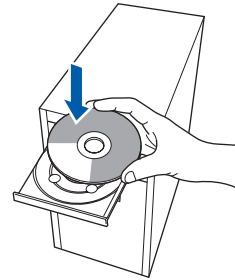

Note

If the Brother screen does not appear automatically, go to **My Computer (Computer)**, double-click the CD-ROM icon, and then double-click **Start.exe**.

- b The CD-ROM main menu will appear. Click **Initial Installation**.



- c Click **Install MFL-Pro Suite**.

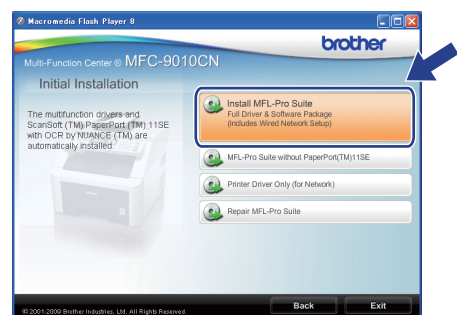



Note

- If the installation does not continue automatically, open the main menu again by ejecting and then reinserting the CD-ROM or double-click the **Start.exe** program from the root folder, and continue from step **c** to install MFL-Pro Suite.
- For Windows Vista®, when the **User Account Control** screen appears, click **Allow**.

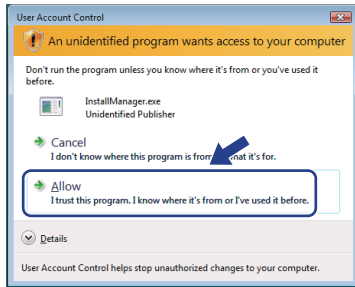

- d** When the ScanSoft™ PaperPort™ 11SE **License Agreement** window appears, click **Yes** if you agree to the Software License Agreement.

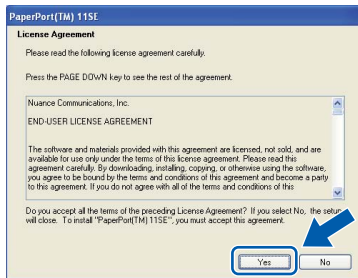

- e** The installation of ScanSoft™ PaperPort™ 11SE will automatically start and is followed by the installation of MFL-Pro Suite.

- f** When the Brother MFL-Pro Suite Software **License Agreement** window appears, click **Yes** if you agree to the Software License Agreement.

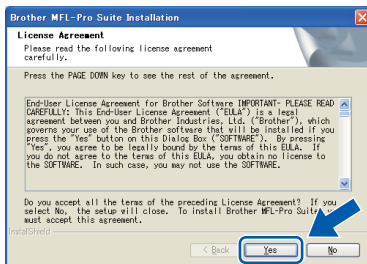

- g** Choose **Local Connection**, and then click **Next**. The installation continues.

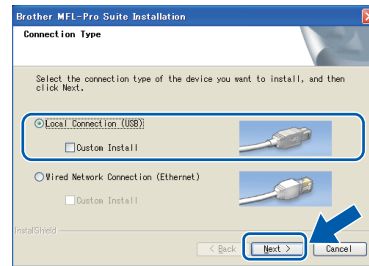

Note

If you want to install the PS driver (Brother's BR-Script Driver), choose **Custom Install** and then follow the on-screen instructions. When the **Select Features** screen appears, check **PS Printer Driver**, and then continue following the on-screen instructions.

- h** If you do not want to monitor the machine status and error notification from your computer, uncheck **Enable Status Monitor** and then click **Next**.

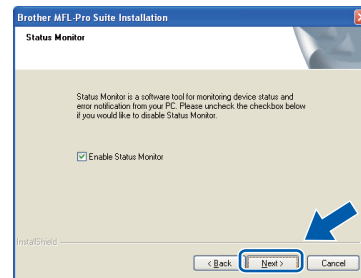

- i** When this screen appears, go to the next step.

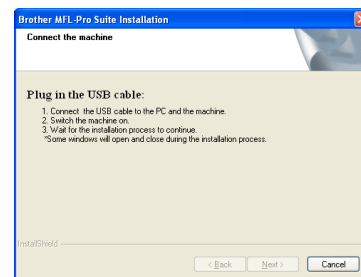





11 Connect the USB cable

! IMPORTANT

- **DO NOT** connect the machine to a USB port on a keyboard or a non-powered USB hub.
- **Connect the machine directly to your computer.**

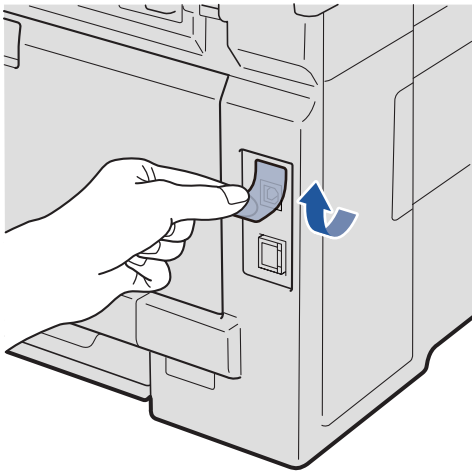
a Remove the label covering the USB interface connector.



b Connect the USB cable to the USB connector on the machine marked with the  symbol. Then connect the cable to your computer.

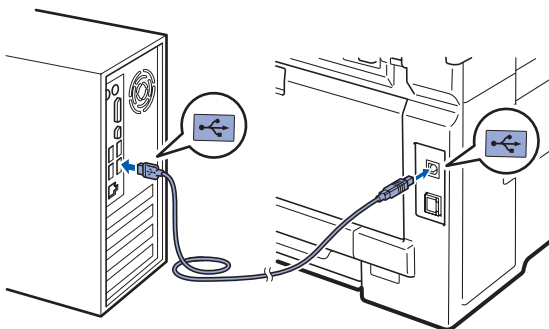

12 Connect the power cord

a Plug the AC power cord into an AC outlet. Turn the power switch on.

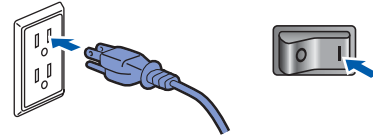

The installation will continue automatically. The installation screens appear one after another.

! IMPORTANT

DO NOT cancel any of the screens during the installation. It may take a few seconds for all screens to appear.

b When the **On-Line Registration** screen is displayed, make your selection and follow the on-screen instructions. Once you have completed the registration process, close your web browser to return to this window. Then click **Next**.

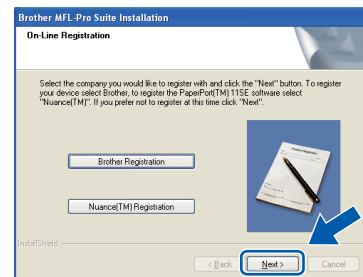



13 Finish and restart

- a Click **Finish** to restart your computer. After restarting the computer, you must be logged on with Administrator rights.

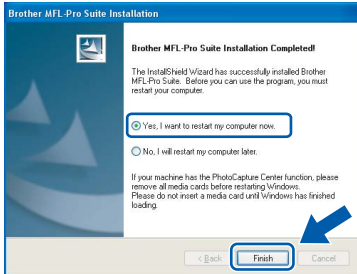

Note

If an error message appears during the software installation, run the **Installation Diagnostics** located in **Start/All Programs/Brother/MFC-XXXX** (where MFC-XXXX is your model name).

- b If this screen appears, choose the firmware update setting and click **OK**.

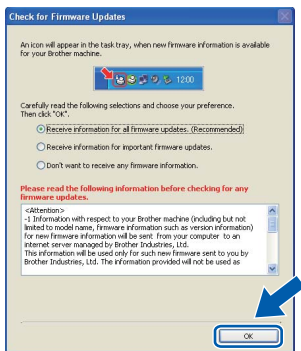

Note

Internet access is required for the firmware upgrade.

Finish The installation is now complete.

Note

XML Paper Specification Printer Driver
The XML Paper Specification Printer Driver is the most suitable driver when printing from the applications that use the XML Paper Specification documents. Please download the latest driver by accessing the Brother Solutions Center at <http://solutions.brother.com/>.



For USB Interface Users (Mac OS X 10.3.9 or greater)

9 Before you install

- a** Make sure your machine is connected to the power and your Macintosh is ON. You must be logged on with Administrator rights.

! IMPORTANT

For the latest drivers and information on the Mac OS X you are using, visit <http://solutions.brother.com/>.

10 Connect the USB cable

! IMPORTANT

- **DO NOT** connect the machine to a USB port on a keyboard or a non-powered USB hub.
- **Connect the machine directly to your Macintosh.**

- a** Remove the label covering the USB interface connector.

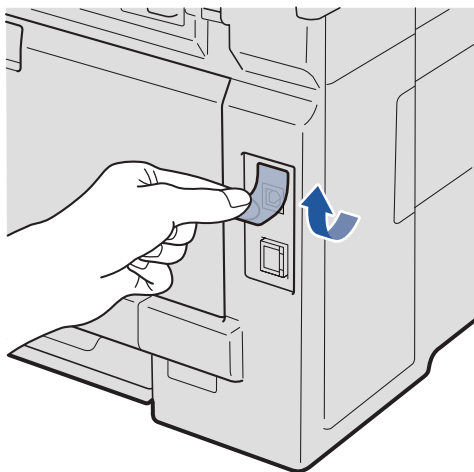

- b** Connect the USB cable to the USB connector on the machine marked with the symbol. Then connect the cable to your computer.

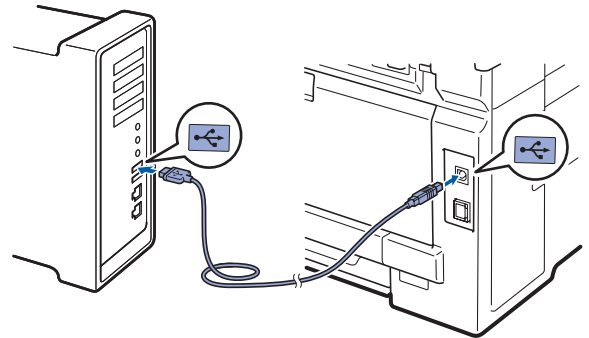

11 Install MFL-Pro Suite

- a** Put the supplied CD-ROM into your CD-ROM drive.

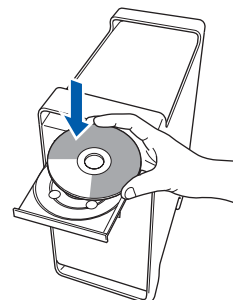

- b** Double-click **Start Here OSX** to install.

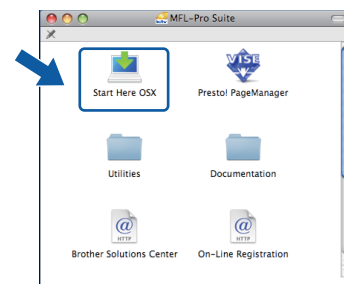

Note

Please see the Software User's Guide on the CD-ROM if you want to install the PS driver. (Brother's BR-Script Driver)

- c** Please wait, it will take a few seconds for the software to install. After the installation, click **Restart** to finish installing the software.



- d** The Brother software will search for the Brother device.
- e** Choose the machine from the list, and then click **OK**.

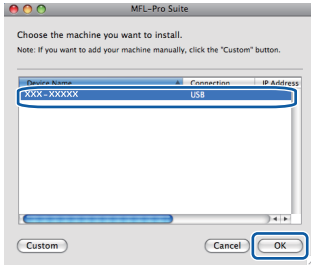

- f** When this screen appears, click **OK**.

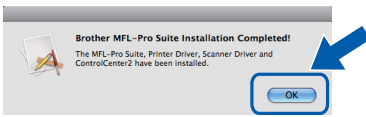

OK! The installation of MFL-Pro Suite is now complete.
Go to step 12 on page 15.

12 Install Presto! PageManager

When Presto! PageManager is installed OCR capability is added to Brother ControlCenter2. You can easily scan, share and organize photos and documents using Presto! PageManager.

- a** Double-click **Presto! PageManager** and follow the on-screen instructions.

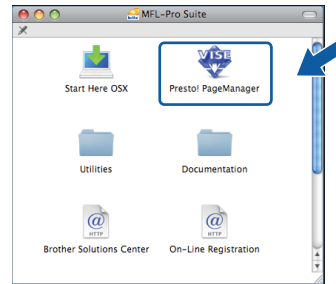

Finish The installation is now complete.

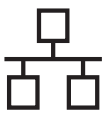

For Wired Network Interface Users (Windows® 2000 Professional/XP/XP Professional x64 Edition/ Windows Vista®)

9 Before you install

- a** Make sure that your computer is ON and you are logged on with Administrator rights.

! IMPORTANT

- If there are any programs running, close them.
- The screens may differ depending on the operating system.
- The supplied CD-ROM includes ScanSoft™ PaperPort™ 11SE. This software supports Windows® 2000 (SP4 or greater), XP (SP2 or greater), XP Professional x64 Edition and Windows Vista®. Update to the latest Windows® Service Pack before installing MFL-Pro Suite.

! IMPORTANT

Disable all personal firewall software (other than Windows® Firewall), anti-spyware or antivirus applications for the duration of the installation.

- b** Unplug the machine from the AC outlet.

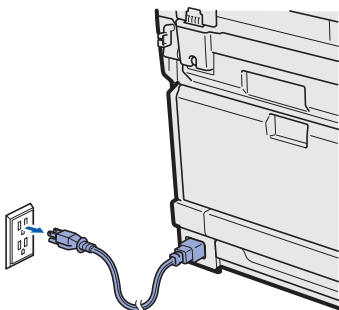

10 Connect the network cable

- a** Connect the network interface cable to the LAN connector marked with a  symbol and then connect it to a free port on your hub.

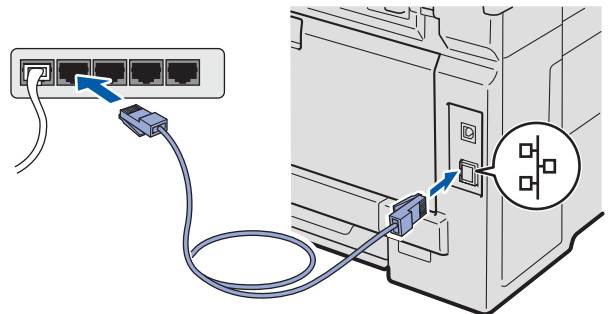

11 Connect the power cord

- a** Plug the AC power cord into an AC outlet. Turn the power switch on.

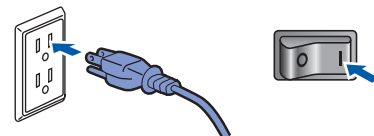

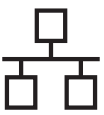

12 Install MFL-Pro Suite

- a** Put the supplied CD-ROM into your CD-ROM drive. If the model name screen appears, choose your machine. If the language screen appears, choose your language.

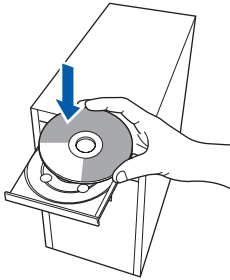

Note

If the Brother screen does not appear automatically, go to **My Computer (Computer)**, double-click the CD-ROM icon, and then double-click **Start.exe**.

- b** The CD-ROM main menu will appear. Click **Initial Installation**.



- c** Click **Install MFL-Pro Suite**.

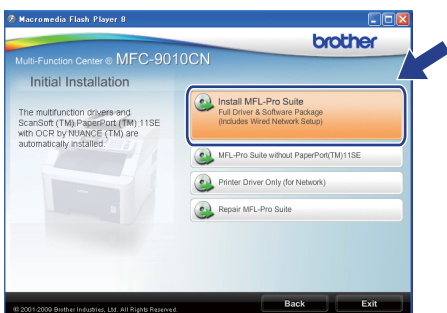

Note

- If the installation does not continue automatically, open the main menu again by ejecting and then reinserting the CD-ROM or double-click the **Start.exe** program from the root folder, and continue from step **c** to install MFL-Pro Suite.
- For Windows Vista®, when the **User Account Control** screen appears, click **Allow**.

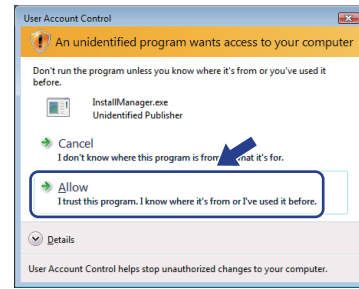

- d** When the ScanSoft™ PaperPort™ 11SE License Agreement window appears, click **Yes** if you agree to the Software License Agreement.

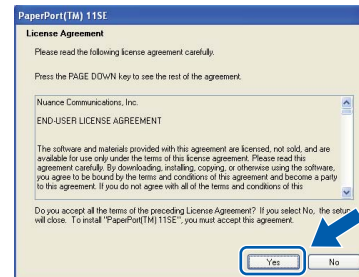

- e** The installation of ScanSoft™ PaperPort™ 11SE will automatically start and is followed by the installation of MFL-Pro Suite.

- f** When the Brother MFL-Pro Suite Software License Agreement window appears, click **Yes** if you agree to the Software License Agreement.

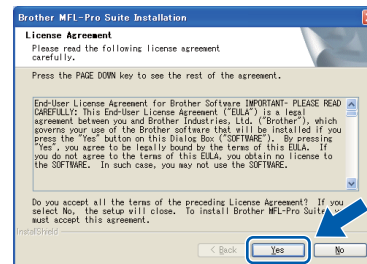

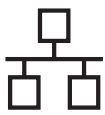

- g** Choose **Wired Network Connection**, and then click **Next**.

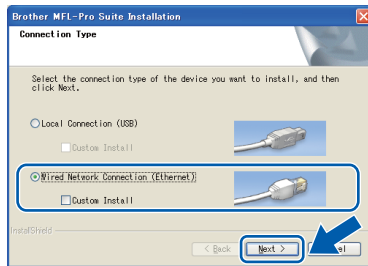

Note
If you want to install the PS driver (Brother's BR-Script Driver), choose **Custom Install** and then follow the on-screen instructions. When the **Select Features** screen appears, check **PS Printer Driver**, and then continue following the on-screen instructions.

- h** For Windows® XP SP2 or greater/XP Professional x64 Edition/ Windows Vista® users, when this screen appears, choose **Change the Firewall port settings to enable network connection and continue with the installation. (Recommended)** and click **Next**.

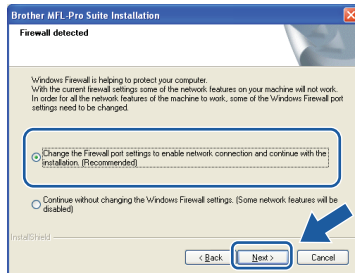

If you are not using the Windows® Firewall, see the User's Guide for your software for information on how to add the following network ports.

- For network scanning, add UDP port 54925.
- If you still have trouble with your network connection, add UDP port 137.

- i** If the machine is configured for your network, choose the machine from the list, and then click **Next**.

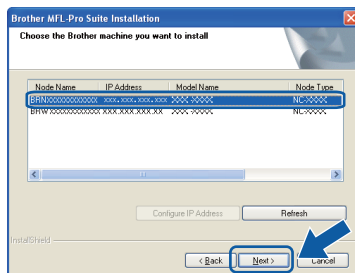

Note

- You can find your machine's IP address and the node name by printing out the **Network Configuration List**. See **Print the Network Configuration List** on page 25.
- If your machine is not found over the network, the following screen will appear.



Confirm your network settings by following the on-screen instructions.

- If the IP Address of the machine is not yet configured for use on your network, the following screen appears.



Click **OK** and then **Configure IP Address**. Enter an IP address for your machine that is suitable for your network by following the on-screen instructions.



- If you do not want to monitor the machine status and error notification from your computer, uncheck **Enable Status Monitor** and then click **Next**.

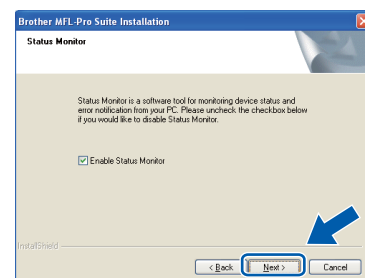

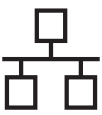

k The installation of the Brother drivers will automatically start. The installation screens appear one after another.

! IMPORTANT

DO NOT cancel any of the screens during the installation. It may take a few seconds for all screens to appear.

Note

For Windows Vista®, when this screen appears, click the check box and click **Install** to complete the installation correctly.

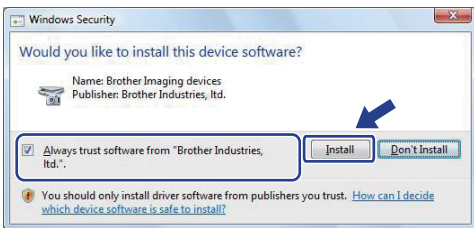

When the **On-Line Registration** screen is displayed, make your selection and follow the on-screen instructions. Once you have completed the registration process, close your web browser to return to this window. Then click **Next**.

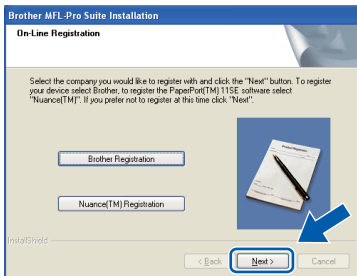

13 Finish and restart

a Click **Finish** to restart your computer. After restarting the computer, you must be logged on with Administrator rights.



Note

If an error message appears during the software installation, run the **Installation Diagnostics** located in **Start/All Programs/Brother/MFC-XXXX LAN** (where MFC-XXXX is your model name).

b If this screen appears, choose the firmware update setting and click **OK**.

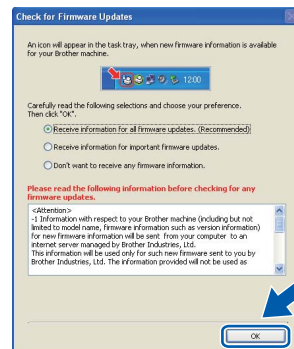

Note

Internet access is required for the firmware upgrade.

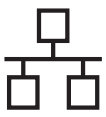

14

Install MFL-Pro Suite on additional computers (if needed)

If you want to use your machine with multiple computers on the network, install MFL-Pro Suite on each computer. Go to step **12** on page 17.



Note

Network license (Windows®)

This product includes a PC license for up to 5 Users. This license supports the installation of the MFL-Pro Suite including ScanSoft™ PaperPort™ 11SE on up to 5 PCs on the network. If you want to use more than 5 PCs with ScanSoft™ PaperPort™ 11SE installed, please purchase the Brother NL-5 pack which is a multiple PC license agreement pack for up to 5 additional users. To purchase the NL-5 pack, contact your authorized Brother dealer or contact Brother customer service.

Finish

The installation is now complete.



Note

XML Paper Specification Printer Driver

The XML Paper Specification Printer Driver is the most suitable driver when printing from the applications that use the XML Paper Specification documents. Please download the latest driver by accessing the Brother Solutions Center at <http://solutions.brother.com/>.

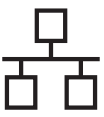

For Wired Network Interface Users (Mac OS X 10.3.9 or greater)

9 Before you install

- a Make sure your machine is connected to the power and your Macintosh is ON. You must be logged on with Administrator rights.

! IMPORTANT

For the latest drivers and information on the Mac OS X you are using, visit <http://solutions.brother.com/>.

10 Connect the network cable

- a Connect the network interface cable to the LAN connector marked with a  and then connect it to a free port on your hub.

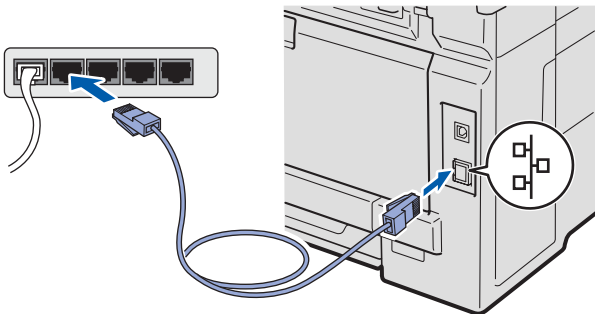

11 Install MFL-Pro Suite

- a Put the supplied CD-ROM into your CD-ROM drive.

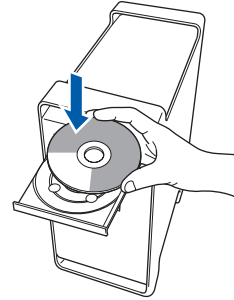

- b Double-click **Start Here OSX** to install.

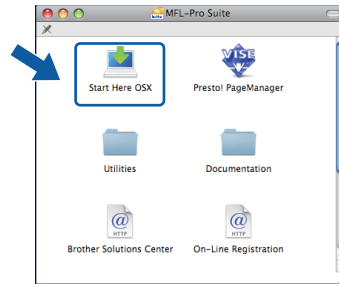

Note

Please see the Network User's Guide on the CD-ROM if you want to install the PS driver. (Brother's BR-Script Driver)

- c Please wait, it will take a few seconds for the software to install. After the installation, click **Restart** to finish installing the software.
- d The Brother software will search for the Brother device.

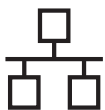

- e** If the machine is configured for your network, choose the machine from the list, and then click **OK**.

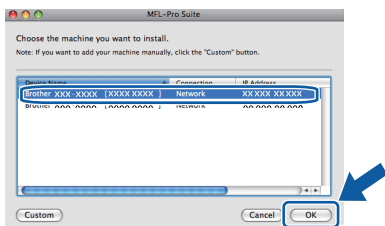

Note

If your machine is not found over the network, confirm your network settings.

Note

If this screen appears click **OK**.

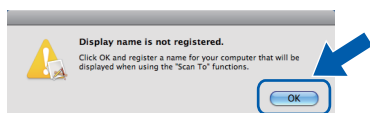

- Enter a name for your Macintosh in **Display Name** up to 15 characters long and click **OK**. Go to **f**.

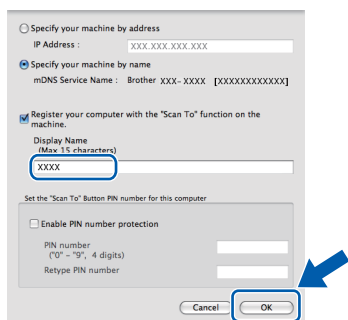

- If you want to use the machine's **Scan** key to scan over the network, you must check the **Register your computer with the "Scan To" function on the machine box**.
- The name you enter will appear on the machine's LCD when you press  and choose a scan option. (For more information, see *Network Scanning in the Software User's Guide on the CD-ROM*.)

- f** When this screen appears, click **OK**.

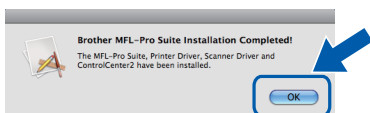

- OK!** The installation of MFL-Pro Suite is now complete. Go to step 12 on page 22.

12 Install Presto! PageManager

When Presto! PageManager is installed OCR capability is added to Brother ControlCenter2. You can easily scan, share and organize photos and documents using Presto! PageManager.

- a** Double-click **Presto! PageManager** and follow the on-screen instructions.

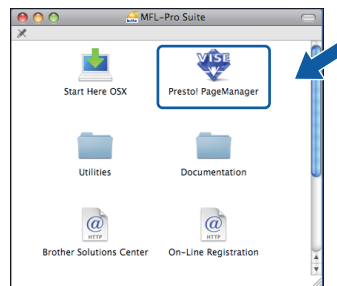

13 Install MFL-Pro Suite on additional computers (if needed)

If you want to use your machine with multiple computers on the network, install MFL-Pro Suite on each computer. Go to step 11 on page 21.

Finish The installation is now complete.

BRAdmin Light utility (for Windows® users)

BRAdmin Light is a utility for initial setup of Brother network connected devices. It also can search for Brother products on your network, view the status and configure basic network settings, such as IP address. For more information on BRAdmin Light, visit us at <http://solutions.brother.com/>.

Note

If you require more advanced printer management, use the latest Brother BRAdmin Professional utility version that is available as a download from <http://solutions.brother.com/>.

Install the BRAdmin Light configuration utility

- a** Click **Network Utilities** on the menu screen.



- b** Click **BRAdmin Light** and follow the on-screen instructions.

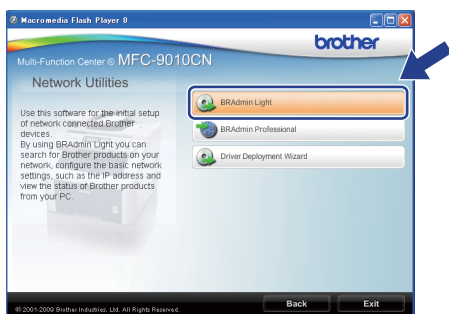

Set your IP address, Subnet Mask and Gateway using BRAdmin Light

Note

If you have a DHCP/BOOTP/RARP server in your network, you do not have to do the following operation. The machine will automatically obtain its own IP address.

- a** Start BRAdmin Light. It will search for new devices automatically.

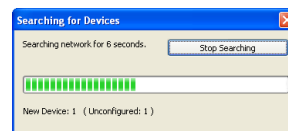

- b** Double-click the unconfigured device.

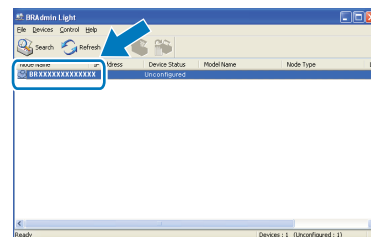

Note

The default password for the machine is 'access'. You can use BRAdmin Light to change this password.

- c** Choose **STATIC** for the **Boot Method**. Enter the **IP Address**, **Subnet Mask** and **Gateway**, and then click **OK**.

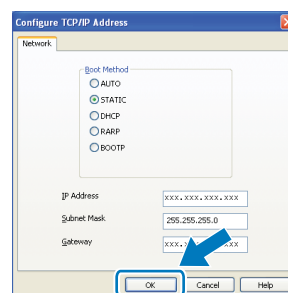

- d** The address information will be saved to the machine.

BRAdmin Light utility (for Mac OS X users)

BRAdmin Light is a utility for initial setup of Brother network connected devices. It also can search for Brother products on your network, view the status and configure basic network settings, such as IP address from a computer running Mac OS X 10.3.9 or greater.

The BRAdmin Light software will be installed automatically when you install the printer driver. If you have already installed the printer driver, you do not have to install BRAdmin Light again. For more information on BRAdmin Light, visit us at <http://solutions.brother.com/>.

Set your IP address, Subnet Mask and Gateway using BRAdmin Light

Note

- If you have a DHCP/BOOTP/RARP server in your network, you do not have to do the following operation. The machine will automatically obtain its own IP address.
- Make sure that version 1.4.2 or greater of Java™ client software is installed on your computer.
- The default password for the machine is 'access'. You can use BRAdmin Light to change this password.

- a** Double-click **Macintosh HD** on your desktop.

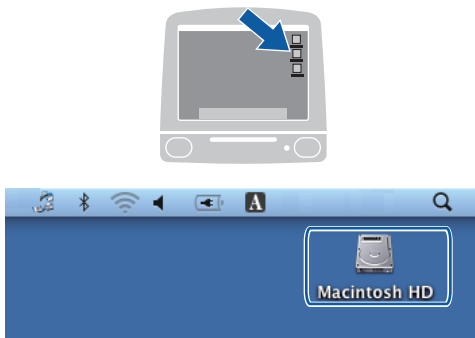

- b** Choose **Library**, **Printers**, **Brother** and then **Utilities**.

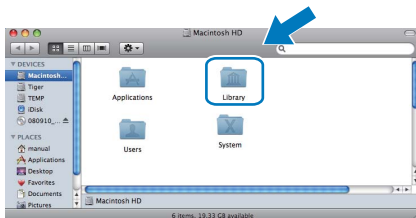

- c** Double-click the file **BRAdmin Light.jar** and run the software. BRAdmin Light will then search for new devices automatically.

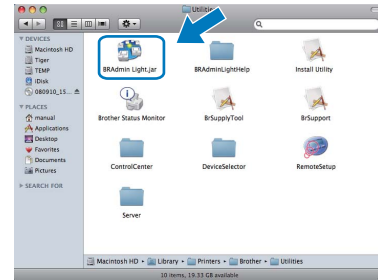

- d** Double-click the unconfigured device.

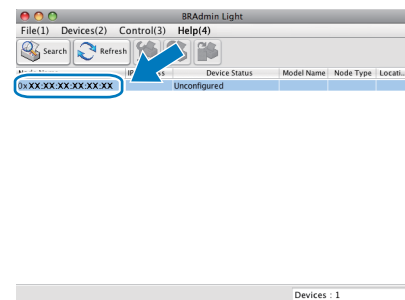

- e** Choose **STATIC** for **Boot Method**. Enter the **IP Address**, **Subnet Mask** and **Gateway**, and then click **OK**.

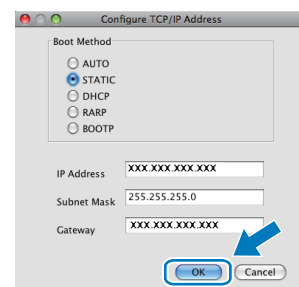

- f** The address information will be saved to the machine.

Web Based Management (web browser)

The Brother print server is equipped with a web server that allows you to monitor its status or change some of its configuration settings, using HTTP (Hyper Text Transfer Protocol).

Note

- The User Name is **'admin'** and the default password is **'access'**. You can use a web browser to change this password.
- We recommend Microsoft® Internet Explorer® 6.0 (or higher) or Firefox 1.0 (or higher) for Windows® and Safari 1.3 for Macintosh. Please also make sure that JavaScript and cookies are always enabled in whichever browser you use. To use a web browser, you will need to know the IP address of the print server. The IP address of the print server is listed on the Network Configuration List.

- a Open your browser.
- b Type `http:// printer_ip_address /` into your browser (Where "printer_ip_address" is the IP address of the printer or the print server name).
 - For example `http://192.168.1.2/`



See Chapter 11 of *the Network User's Guide*.

Print the Network Configuration List

You can print the Network Configuration List to confirm the current network settings. To print the Network Configuration List:

- a Turn on the machine and wait until the machine is in the Ready state.

- b Press **Menu, 5, 4**.

Machine Info.
4. Network Config

- c Press **Start**.

The machine will print the current network settings.

Restore the network settings to factory default

To restore all network settings of the internal Print/Scan server to factory default, please follow the steps below.

- a Make sure the machine is not operating, then disconnect all the cables from the machine (except the power cord).

- b Press **Menu, 4, 0**.

Network
0. Network Reset

- c Press **1** to choose **Reset**.

- d Press **1** to choose **Yes**.

- e The machine will restart, re-connect cables once this is complete.

Options

The machine has the following optional accessory. You can expand the capabilities of the machine by adding this item. For more information about compatible SO-DIMM Memory, visit us at <http://solutions.brother.com/>.

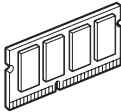

For installing the SO-DIMM Memory, see the User's Guide or visit <http://solutions.brother.com/>.

SO-DIMM Memory
<p>You can expand the memory by installing a (144-pin SO-DIMM) memory module.</p> 

When the time comes to replace consumable items, an error will be indicated by the LCD on the control panel. For more information about the consumables for your machine, visit us at <http://solutions.brother.com/> or contact your local Brother reseller.

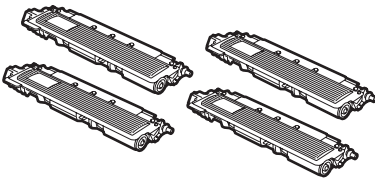
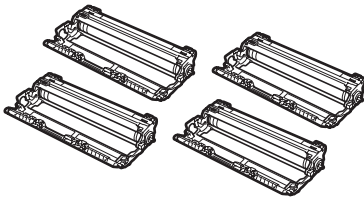
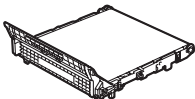
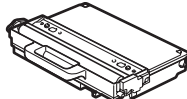
Toner cartridges	Drum units
TN-210C/TN-210M/TN-210Y/TN-210BK	DR-210CL ¹
	
Belt Unit (BU-200CL)	Waste Toner Box (WT-200CL)
	

¹ Contains a set of three color drums and one black drum. All four drums are replaced at the same time.

Trademarks

The Brother logo is a registered trademark of Brother Industries, Ltd.

Brother is a registered trademark of Brother Industries, Ltd.

Multi-Function Link is a registered trademark of Brother International Corporation.

Windows Vista is either a registered trademark or a trademark of Microsoft Corporation in the United States and/or other countries.

Microsoft, Windows and Windows Server and Internet Explorer are registered trademarks of Microsoft Corporation in the United States and/or other countries.

Apple, Macintosh, Safari and TrueType are trademarks of Apple Inc., registered in the United States and other countries.

Nuance, the Nuance logo, PaperPort and ScanSoft are trademarks or registered trademarks of Nuance Communications, Inc. or its affiliates in the United States and/or other countries.

Each company whose software title is mentioned in this manual has a Software License Agreement specific to its proprietary programs.

All other brand and product names mentioned in this manual are trademarks or registered trademarks of their respective companies.

Compilation and Publication

Under the supervision of Brother Industries, Ltd., this manual has been compiled and published, covering the latest product descriptions and specifications.

The contents of this manual and the specifications of this product are subject to change without notice.

Brother reserves the right to make changes without notice in the specifications and materials contained herein and shall not be responsible for any damages (including consequential) caused by reliance on the materials presented, including but not limited to typographical and other errors relating to the publication.

Copyright and License

©2009 Brother Industries, Ltd.

This product includes software developed by the following vendors:

©1983-1998 PACIFIC SOFTWARES, INC.

This product includes the "KASAGO TCP/IP" software developed by ELMIC WESCOM, Inc.

©2009 Devicescape Software, Inc.