









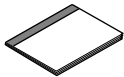
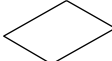
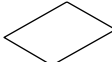

Thank you for choosing Brother, your support is important to us and we value your business. Your Brother product is engineered and manufactured to the highest standards to deliver reliable performance, day-in and day-out. Before using the machine, please read this Quick Setup Guide for the correct setup and installation. To view the Quick Setup Guide in other languages, please visit <http://solutions.brother.com/>.

 <b>WARNING</b>	WARNING indicates a potentially hazardous situation which, if not avoided, could result in death or serious injuries.
 <b>IMPORTANT</b>	IMPORTANT indicates a potentially hazardous situation which, if not avoided, may result in damage to property or loss of product functionality.
 <b>Note</b>	Notes tell you how you should respond to a situation that may arise or give tips about how the operation works with other features.
 <b>User's Guide Network User's Guide</b>	Indicates reference to the User's Guide or Network User's Guide which is on the CD-ROM we have supplied.

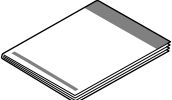
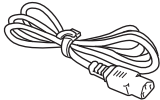
# 1

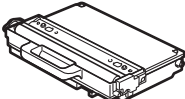
## Unpack the machine and check the components

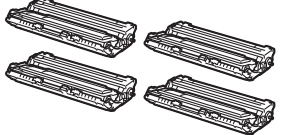
	 <b>User's Guide</b>	 <b>Accessory Order Form</b>	 <b>Product Registration Sheet</b> (USA only)
 <b>CD-ROM</b> (Windows®) (Macintosh)	 <b>Quick Setup Guide</b>	 <b>AC Power Cord</b>	 <b>Telephone Line Cord</b>
 <b>Waste Toner Box</b> (pre-installed)	 <b>Belt Unit</b> (pre-installed)	 <b>Drum Unit and Starter Toner Cartridge Assemblies</b> (Black, Cyan, Magenta and Yellow)	

## WARNING

- Plastic bags are used in the packaging of your machine. To avoid danger of suffocation, please keep these bags away from babies and children.
- This machine is heavy and weighs approximately 50.5 lb. (22.9 kg). To prevent injuries use at least two people to lift the machine. Be careful not to pinch your fingers when you put the machine back down.

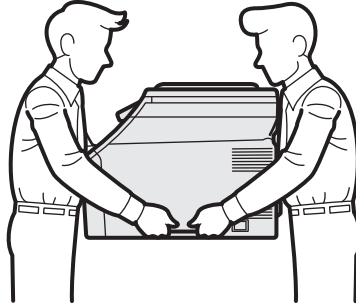

### Note

Keep a minimum gap around the machine as shown in the illustration.

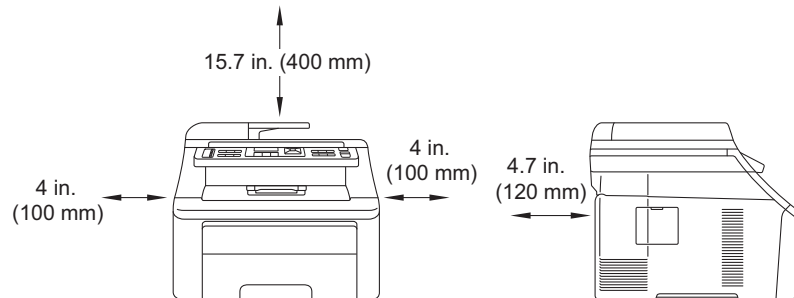

### Note

- The components included in the box may differ depending on your country.
- Save all packing materials and the box in case for any reason you must ship your machine.
- The interface cable is not a standard accessory. Buy the appropriate interface cable for the interface you want to use (USB or Network).

#### **USB cable**

- Please make sure you use a USB 2.0 cable (Type A/B) that is no longer than 6 feet (2 meters).
- DO NOT connect the interface cable at this time. Connecting the interface cable is done during MFL-Pro installation process.
- When you use a USB cable, make sure you connect it to the USB port of your computer and not to a USB port on a keyboard or non-powered USB hub.

#### **Network cable**

Use a straight-through Category 5 (or greater) twisted-pair cable for 10BASE-T or 100BASE-TX Fast Ethernet Network.

## 2 Remove the packing material from the machine

### ! IMPORTANT

- Save all packing material and the carton in case you have to ship your machine.
- DO NOT plug in the AC power cord yet.

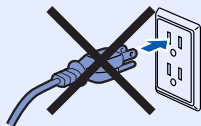

**a** Remove the packing tape from the outside of the machine.

**b** Open the top cover by lifting up on the handle 1.

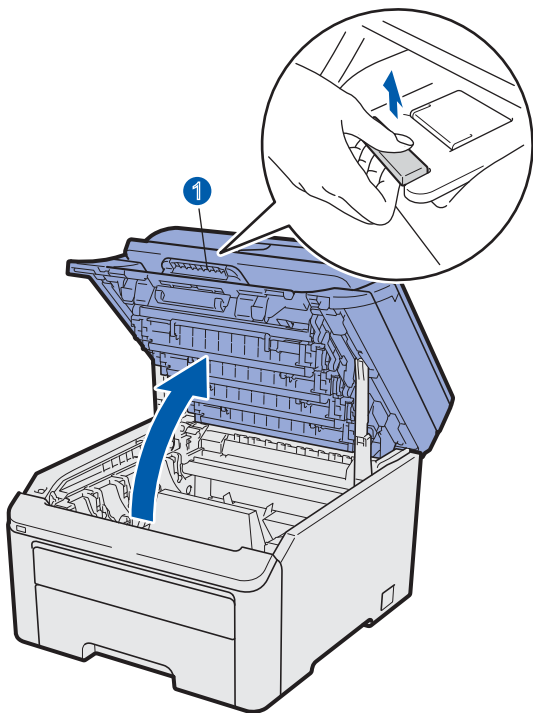

**c** Remove the packing material from the inside of the machine.

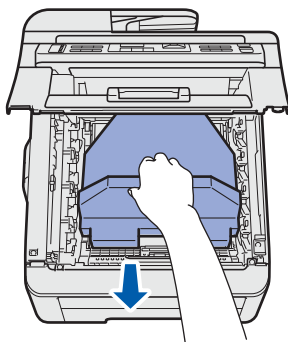

## 3 Install the drum unit and toner cartridge assemblies

**a** Unpack the four drum unit and toner cartridge assemblies and gently shake each of them from side to side several times to distribute the toner evenly inside the assembly.

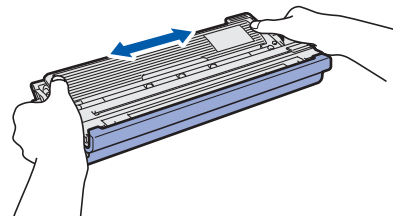

**b** Remove the protective cover by pulling on the tab as shown in the illustration.

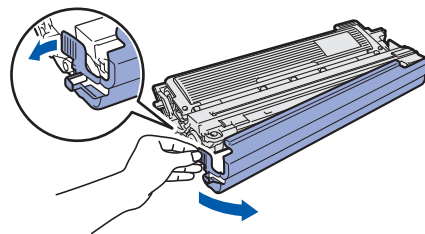

### Note

*Do not touch the surface of the packing film. It may contain toner powder which can stain your skin and clothing.*

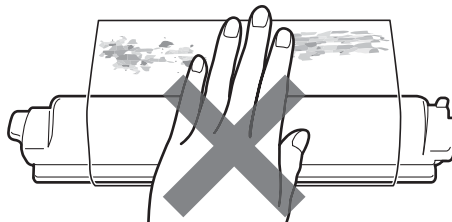

### ! IMPORTANT

**To avoid print quality problems, DO NOT touch the surface of the drum unit.**

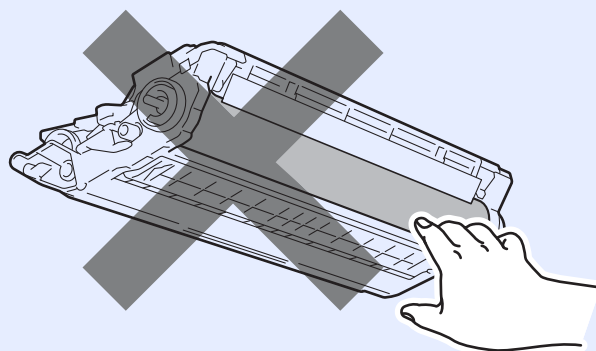

- C** Slide all four of the drum unit and toner cartridge assemblies into the machine as shown in the illustration. Make sure that you match the toner cartridge color to the same color label on the machine.

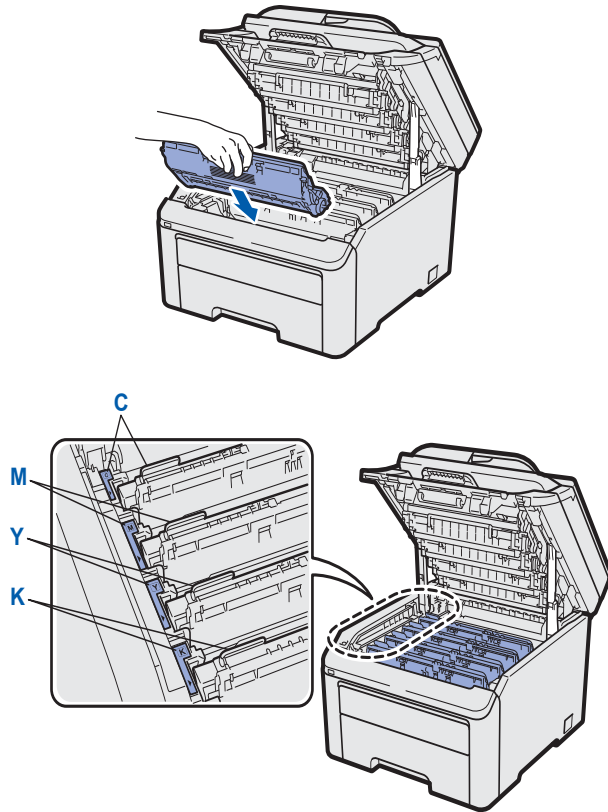

- d** Close the top cover of the machine.

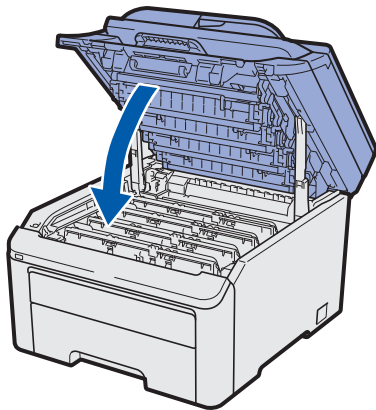

## 4 Load paper in the paper tray

- a** Pull the paper tray completely out of the machine.

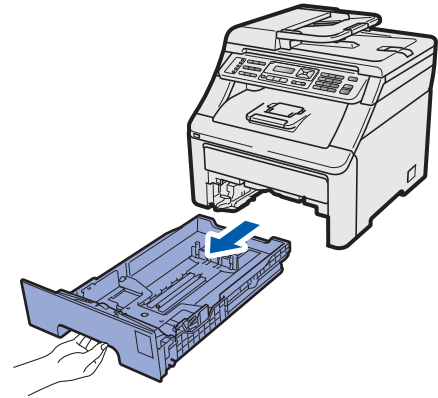

- b** While pressing the green paper-guide release lever ①, slide the paper guides to fit the paper size you are loading in the tray. Make sure that the guides are firmly in the slots.

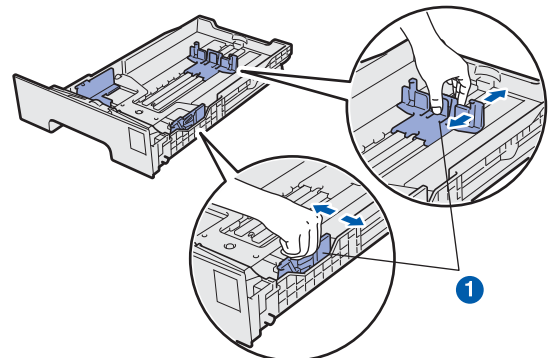

- C** Fan the stack of paper well to avoid paper jams and misfeeds.

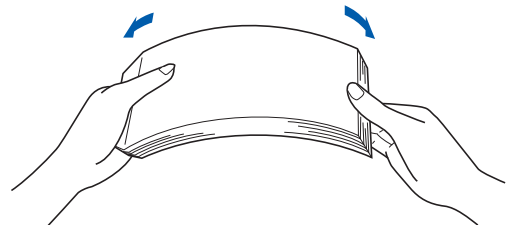

- d** Put paper in the tray, and make sure that the paper is below the maximum paper mark **1**. The side to be printed on must be face down.

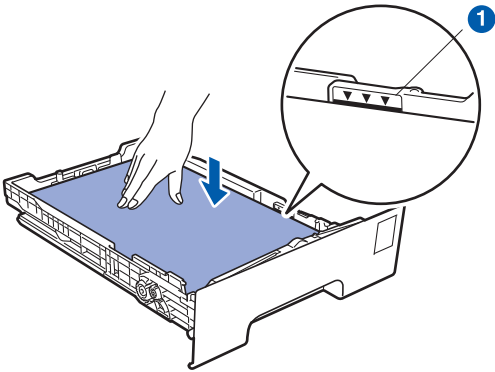

**! IMPORTANT**

**Make sure the paper guides touch the sides of the paper so it will feed properly.**

- e** Put the paper tray firmly back in the machine. Make sure that it is completely inserted into the machine.

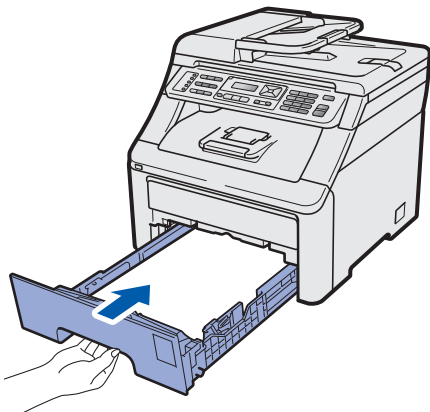

- f** Unfold the support flap **1** to prevent paper from sliding off the face-down output tray.

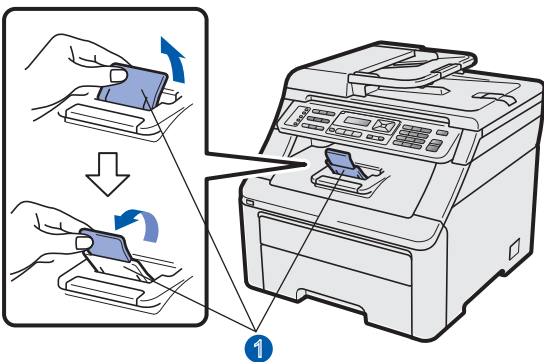

## 5 Connect the power cord and telephone line

**! IMPORTANT**

**DO NOT connect the interface cable yet.**

- a** Make sure that the machine's power switch is off. Connect the AC power cord to the machine.

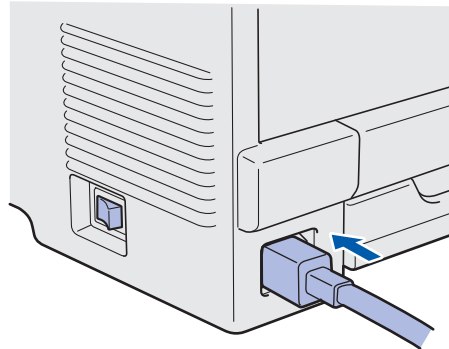

- b** Plug the AC power cord into an AC outlet. Turn the power switch on.

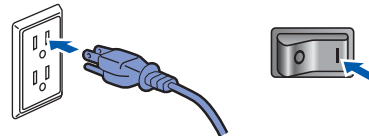

- c** Connect the telephone line cord. Connect one end of the telephone line cord to the jack on the machine marked **LINE** and the other end to a modular wall jack.

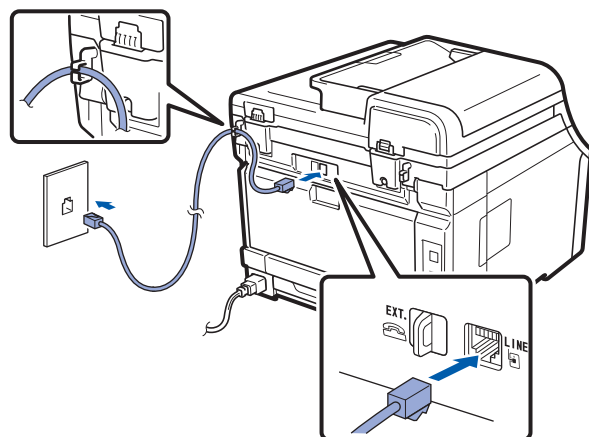

**! IMPORTANT**

The telephone line cord **MUST** be connected to the jack on the machine marked **LINE**.

**! WARNING**

The machine must be grounded using a 3-prong plug.

Since the machine is grounded through the power outlet, you can protect yourself from potentially hazardous electrical conditions on the telephone network by keeping the power cord connected to your machine when you connect it to a telephone line. Similarly, you can protect yourself when you want to move your machine by disconnecting the telephone line first and then the power cord.

**Note**

If you are sharing one telephone line with an external telephone, connect it as shown below. Before you connect the external telephone, remove the protective cap 1 from the **EXT.** jack on the machine.

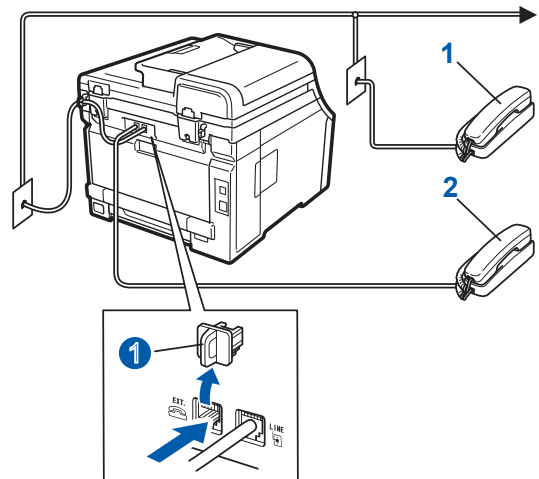

- 1 Extension telephone
- 2 External telephone

**Note**

If you are sharing one telephone line with an external telephone answering machine, connect it as shown below. Before you connect the external telephone answering machine, remove the protective cap 1 from the **EXT.** jack on the machine.

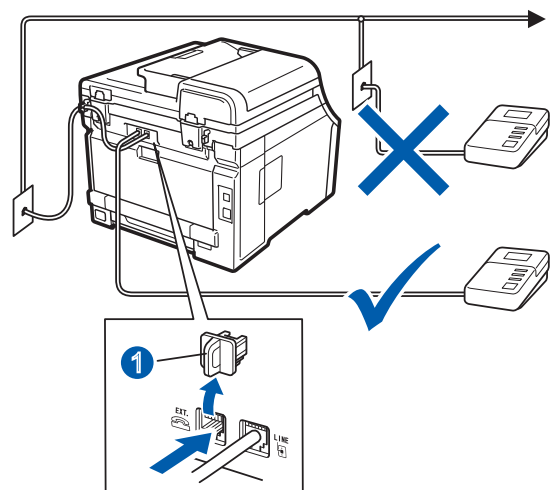

**🔍** Set the receive mode to *External TAD* if you have an external answering machine. See *Choose the correct Receive Mode* on page 8. For additional details, see *Connecting an external TAD (telephone answering device)* in Chapter 7 of the User's Guide.

# 6

## Choose your language (if needed)

**a** Press **Menu, 0, 0**.

```
Initial Setup
0.Local Language
```

**b** Press **▲** or **▼** to choose your language.  
Press **OK**.

**c** Press **Stop/Exit**.

# 7

## Choose the correct Receive Mode

The correct Receive Mode is determined by the external devices and telephone subscriber services (Voice Mail, Distinctive Ring, etc.) you have (or will be using) on the same line as the Brother machine.

### Will you be using a Distinctive Ring number for receiving faxes?

Brother uses the term “Distinctive Ring” but telephone companies may have other names for this service such as Custom Ringing, RingMaster, Personalized Ring, Teen Ring, Ident-A-Call, and Smart Ring. See *Distinctive Ring* in Chapter 7 of the *User’s Guide* for instruction on setting up your machine using this feature.

### Will you be using Voice Mail on the same telephone line as your Brother machine?

If you have Voice Mail on the same telephone line as your Brother machine, there is a strong possibility that Voice Mail and the Brother machine will conflict with each other when receiving incoming calls. See *Voice Mail* in Chapter 7 of the *User’s Guide* for instructions on setting up your machine using this service.

### Will you be using a Telephone Answering Device on the same telephone line as your Brother machine?

Your external telephone answering device (TAD) will automatically answer every call. Voice messages are stored on the external TAD and fax messages are printed. Choose `External TAD` as your receive mode. See the instructions below.

### Will you be using your Brother machine on a dedicated fax line?

Your machine automatically answers every call as a fax. Choose `Fax Only` as your receive mode. See the instructions below.

### Will you be using your Brother machine on the same line as your telephone?

#### Do you want to receive voice calls and faxes automatically?

The `Fax/Tel` receive mode is used when sharing the Brother machine and your telephone on the same line. Choose `Fax/Tel` as your receive mode. See the instructions below.

**Important Note:** You cannot receive voice messages on either Voice Mail or an answering machine when choosing the `Fax/Tel` mode.

#### Do you expect to receive very few faxes?

Choose `Manual` as your receive mode. You control the phone line and must answer every call yourself. See the instructions below.



For details, see Using receive modes in Chapter 6 of the *User’s Guide*.

**a** Press **Menu**, **0**, **1**.

```
Initial Setup
1.Receive Mode
```

**b** Press **▲** or **▼** to choose the receive mode.  
Press **OK**.

**c** Press **Stop/Exit**.



## 8 Set the LCD contrast (if needed)

If you are having difficulty reading the LCD, try changing the contrast setting.

- a** Press **Menu**, **1**, **6**.

```
General Setup
6.LCD Contrast
```

- b** Press **▲** to increase the contrast.  
—OR—  
Press **▼** to decrease the contrast.  
Press **OK**.

- c** Press **Stop/Exit**.

## 9 Set the date and time

The machine displays the time, and if you set up the station ID the date and time will be added to each fax you send.

- a** Press **Menu**, **0**, **2**.

- b** Enter the last two digits of the year on the dial pad, and then press **OK**.

```
Date&Time
Year:2009
```

(e.g. Enter **0**, **9** for 2009.)

- c** Enter the two digits for the month on the dial pad, and then press **OK**.

```
Date&Time
Month:03
```

(e.g. Enter **0**, **3** for March.)

- d** Enter the two digits for the day on the dial pad, and then press **OK**.

```
Date&Time
Day:25
```

(e.g. Enter **2**, **5**.)

- e** Enter the time in 24-hour format on the dial pad, and then press **OK**.

```
Date&Time
Time:15:25
```

(e.g. Enter **1** **5**, **2** **5** for 3:25 P.M.)

- f** Press **Stop/Exit**.

## 10 Set your Station ID

You should store your name and fax number to be printed on all fax pages that you send.

- a** Press **Menu**, **0**, **3**.

- b** Enter your fax number (up to 20 digits) on the dial pad, and then press **OK**.

```
Station ID
Fax:
```

- c** Enter your telephone number (up to 20 digits) on the dial pad, and then press **OK**. (If your telephone number and fax number are the same, enter the same number again.)

```
Station ID
Tel:
```

- d** Use the dial pad to enter your name (up to 20 characters), and then press **OK**.

```
Station ID
Name:
```

### Note

- See the following chart for entering your name.
- If you need to enter a character that is on the same key as the last character, press **▶** to move the cursor to the right.
- If you entered a letter incorrectly and want to change it, press **◀** or **▶** to move the cursor to the incorrect character, press **Clear/Back**.

Press key	One time	Two times	Three times	Four times	Five times
2	A	B	C	2	A
3	D	E	F	3	D
4	G	H	I	4	G
5	J	K	L	5	J
6	M	N	O	6	M
7	P	Q	R	7	P
8	T	U	V	8	T
9	W	X	Y	9	W



For more details, see *Entering text in the User's Guide*.

**e** Press **Stop/Exit**.

 **Note**

*If you make a mistake and want to start again, press **Stop/Exit** and go back to step **a**.*

*(USA only) The Telephone Consumer Protection Act of 1991 makes it unlawful for any person to use a computer or electronic device to send any message via a telephone fax machine unless such messages clearly contain, in a margin at the top or bottom of each transmitted page, or on the first page of the transmission, the date and time it is sent and an identification of the business or other entity or other individual sending the message and the telephone number of the sending machines or such business, other entity or individual. To program this information into your machine, see *Set the date and time on page 9* and *Set your Station ID on page 9*.*

## **11** Fax Transmission Report

Your Brother machine is equipped with a Transmission Verification Report that can be used as confirmation that you sent a fax. This report lists the name or fax number of the receiving party, the date, time, and duration of the transmission, the number of pages transmitted, and whether or not the transmission was successful. If you want to use the Fax Transmission Report feature see *Chapter 11 Printing reports* in the *User's Guide*.

## **12** Set tone or pulse dialing mode (Canada only)

Your machine comes set for Tone dialing service. If you have Pulse dialing service (rotary), you need to change the dialing mode.

- a** Press **Menu**, **0**, **4**.
- b** Press **▼** or **▲** to choose **Pulse** (or **Tone**). Press **OK**.
- c** Press **Stop/Exit**.

# 13 Dial Prefix

The dial prefix setting will automatically dial a predefined number before every fax number you dial. For example: If your phone system requires a 9 to dial an outside number this setting will automatically dial 9 for every fax you send.

- a** Press **Menu**, **0**, **5** (For Canada, press **6**).
- b** Enter the prefix number (up to 5 digits) on the dial pad, and then press **OK**.

### Note

- You can use the number 0 to 9, #, \* and !. (Press **Hook** to display "!".) You cannot use ! with any other numbers or characters. If your telephone system requires a timed break recall (hookflash), press **Hook** to enter the break.
- If the pulse dialing mode is on, # and \* are not available to use. (Canada only)

- c** Press **Stop/Exit**.

# 14 Automatic Daylight Savings Time

You can set the machine to change automatically for daylight savings time. It will reset itself forward one hour in the Spring and backward one hour in the Fall.

- a** Press **Menu**, **1**, **4**.



- b** Press **▲** or **▼** to choose **On** (or **Off**). Press **OK**.
- c** Press **Stop/Exit**.

# 15 Send in the Product Registration and Test Sheet (USA only)

You can also register your product online using the On-Line Registration link from the installation CD-ROM or visit <http://www.brother.com/registration/>.

- a** Fill out the Product Registration and Test Sheet.

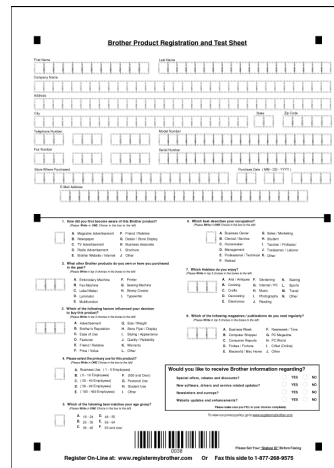

- b** Put the sheet face up in the ADF (Automatic Document Feeder) or face down on the scanner glass.

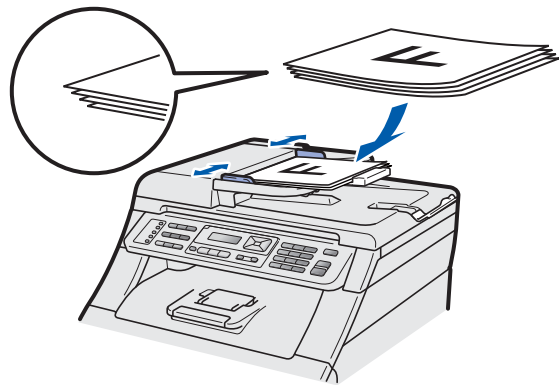

- c** Make sure  (**Fax**) is illuminated in Blue.
- d** Enter the toll-free fax number: 1-877-268-9575.
- e** Press **Black Start** or **Color Start**.

### Note

You will receive a confirmation fax of your Product Registration.



# 16

## Choose your connection type

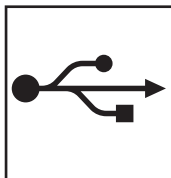
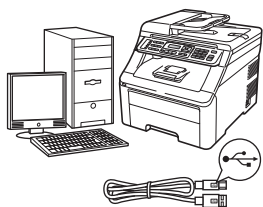

### For USB Interface Users

Windows<sup>®</sup>, go to page 14  
Macintosh, go to page 18

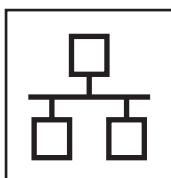
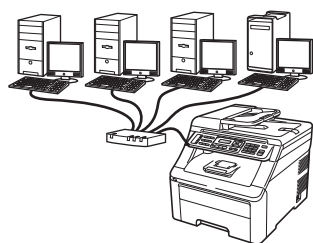

### For Wired Network

Windows<sup>®</sup>, go to page 20  
Macintosh, go to page 25



#### Note

For Windows Server<sup>®</sup> 2003/ 2008, see the Network User's Guide on the CD-ROM.

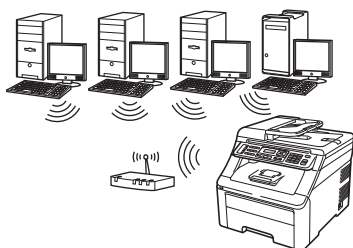

### For Wireless Network

Windows<sup>®</sup> and Macintosh, go to page 27

USB	Windows <sup>®</sup>
	Macintosh
Wired Network	Windows <sup>®</sup>
	Macintosh
Wireless Network	Windows <sup>®</sup>
	Macintosh



## For USB Interface Users (Windows® 2000 Professional/XP/XP Professional x64 Edition/ Windows Vista®/Windows® 7)

### 17 Before you install

- a Make sure that your computer is ON and you are logged on with Administrator rights.

#### ! IMPORTANT

- **DO NOT** connect the USB cable yet.
- If there are any programs running, close them.
- Make sure a USB Flash memory device is not inserted into the machine.
- The screen may differ depending on the operating system.
- The supplied CD-ROM includes ScanSoft™ PaperPort™ 11SE. This software supports Windows® 2000 (SP4 or greater), XP (SP2 or greater), XP Professional x64 Edition, Windows Vista® and Windows® 7. Update to the latest Windows® Service Pack before installing MFL-Pro Suite.

- b Turn off and unplug the machine from the AC outlet and disconnect it from your computer, if you already connected an interface cable.

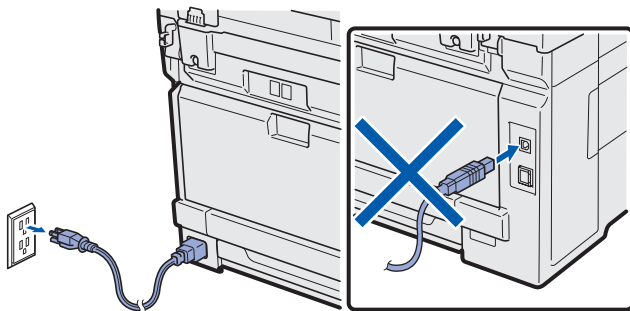

### 18 Install MFL-Pro Suite

- a Put the supplied CD-ROM into your CD-ROM drive. If the model name screen appears, choose your machine. If the language screen appears, choose your language.

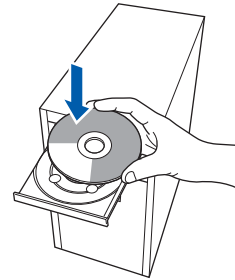

#### Note

If the Brother screen does not appear automatically, go to **My Computer (Computer)**, double-click the CD-ROM icon, and then double-click **Start.exe**.

- b The CD-ROM main menu will appear. Click **Initial Installation**.



- c Click **Install MFL-Pro Suite**.





## Note

- If the installation does not continue automatically, open the main menu again by ejecting and then reinserting the CD-ROM or double-click the **Start.exe** program from the root folder, and continue from step **c** to install MFL-Pro Suite.
- For Windows Vista® and Windows® 7, when the **User Account Control** screen appears, click **Allow** or **Yes**.

- d** When the ScanSoft™ PaperPort™ 11SE **License Agreement** window appears, click **Yes** if you agree to the Software License Agreement.

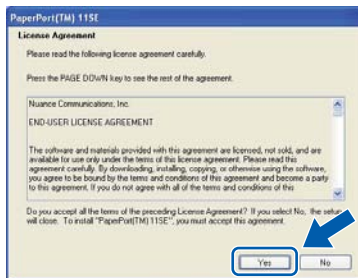

- e** The installation of ScanSoft™ PaperPort™ 11SE will automatically start and is followed by the installation of MFL-Pro Suite.

- f** When the Brother MFL-Pro Suite Software **License Agreement** window appears, click **Yes** if you agree to the Software License Agreement.

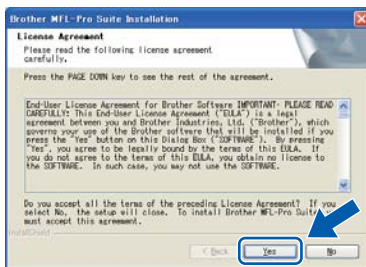

- g** Choose **Local Connection**, and then click **Next**. The installation continues.

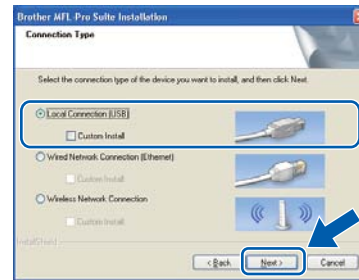

## Note

If you want to install the PS driver (Brother's BR-Script Driver), choose **Custom Install** and then follow the on-screen instructions. When the **Select Features** screen appears, check **PS Printer Driver**, and then continue following the on-screen instructions.

- h** If you do not want to monitor the machine status and error notification from your computer, uncheck **Enable Status Monitor** and then click **Next**.



- i** When this screen appears, go to the next step.







## 19 Connect the USB cable

### ! IMPORTANT

- **DO NOT** connect the machine to a USB port on a keyboard or a non-powered USB hub.
- **Connect the machine directly to your computer.**

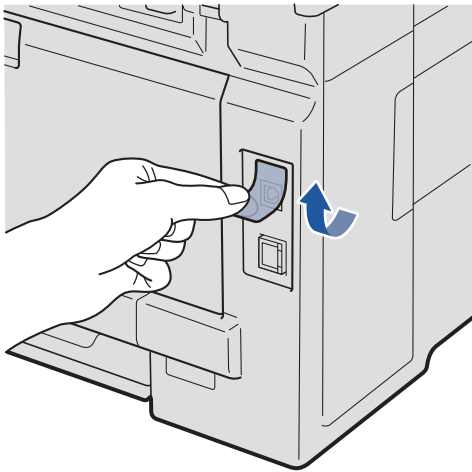
**a** Remove the label covering the USB interface connector.



**b** Connect the USB cable to the USB connector on the machine marked with the  symbol. Then connect the cable to your computer.

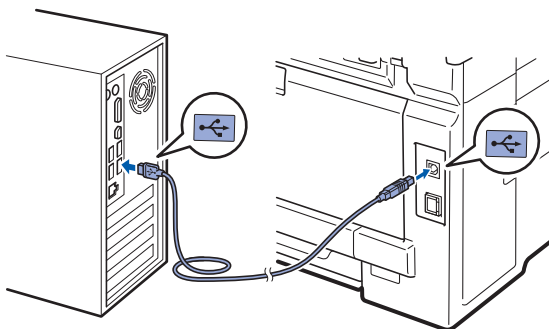

## 20 Connect the power cord

**a** Plug the AC power cord into an AC outlet. Turn the power switch on.

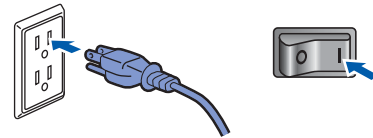

The installation will continue automatically. The installation screens appear one after another.

### ! IMPORTANT

**DO NOT** cancel any of the screens during the installation. It may take a few seconds for all screens to appear.

### Note

For Windows Vista® and Windows® 7, when this screen appears, click the check box and click **Install** to complete the installation correctly.



**b** When the **On-Line Registration** screen is displayed, make your selection and follow the on-screen instructions. Once you have completed the registration process, close your web browser to return to this window. Then click **Next**.







## 21 Finish and restart

- a Click **Finish** to restart your computer. After restarting the computer, you must be logged on with Administrator rights.

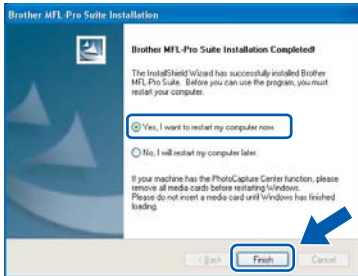

### Note

If an error message appears during the software installation, run the **Installation Diagnostics** located in **Start/All Programs/Brother/MFC-XXXX** (where MFC-XXXX is your model name).

- b If this screen appears, choose the firmware update setting and click **OK**.

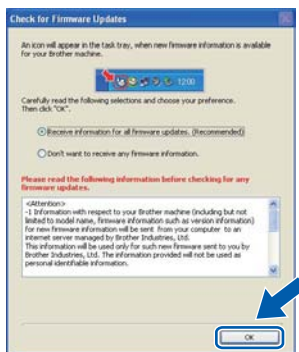

### Note

Internet access is required for the firmware upgrade.

## Finish

The installation is now complete.

### Note

**XML Paper Specification Printer Driver**  
The XML Paper Specification Printer Driver is the most suitable driver for Windows Vista® and Windows® 7 when printing from the applications that use the XML Paper Specification documents. Please download the latest driver by accessing the Brother Solutions Center at <http://solutions.brother.com/>.



## For USB Interface Users (Mac OS X 10.3.9 or greater)

### 17 Before you install

**a** Make sure your machine is connected to the power and your Macintosh is ON. You must be logged on with Administrator rights.

#### ! IMPORTANT

- For the latest drivers and information on the Mac OS X you are using, visit <http://solutions.brother.com/>.
- Make sure a USB Flash memory device is not inserted into the machine.

### 18 Connect the USB cable

#### ! IMPORTANT

- DO NOT connect the machine to a USB port on a keyboard or a non-powered USB hub.
- Connect the machine directly to your Macintosh.

**a** Remove the label covering the USB interface connector.

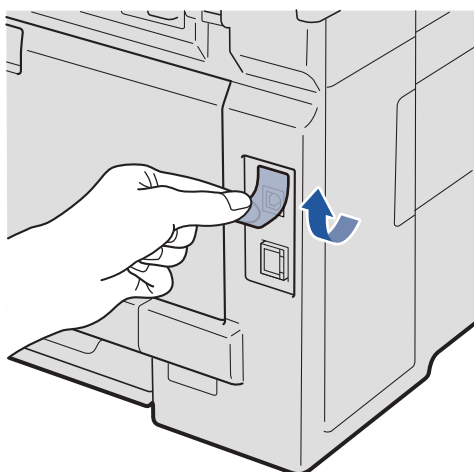

**b** Connect the USB cable to the USB connector on the machine marked with the  symbol. Then connect the cable to your computer.

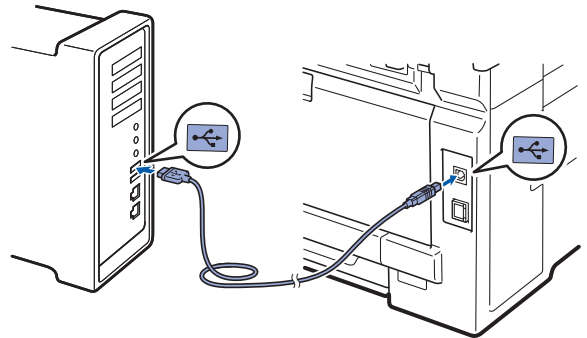

### 19 Install MFL-Pro Suite

**a** Put the supplied CD-ROM into your CD-ROM drive.

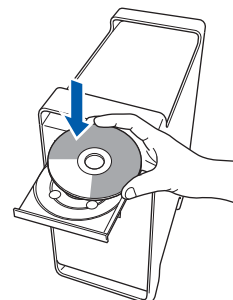

**b** Double-click **Start Here OSX** to install.

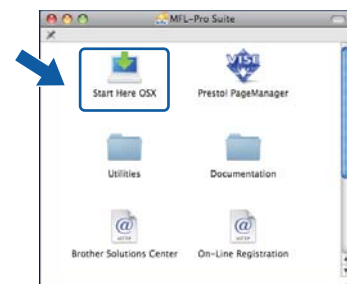

#### Note

Please see the Software User's Guide on the CD-ROM if you want to install the PS driver. (Brother's BR-Script Driver)



- c** Choose **Local Connection**, and then click **Next**. Follow the on-screen instructions.



### Note

*Please wait, it will take a few seconds for the software to install. (Mac OS X 10.3.9 only) After the installation, click **Restart** to finish installing the software.*

- d** The Brother software will search for the Brother device.
- e** Choose the machine from the list, and then click **OK**.

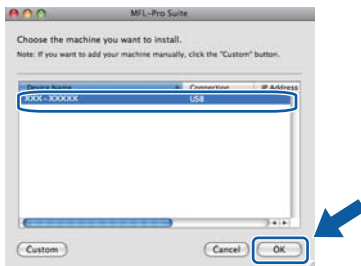

- f** When this screen appears, click **OK**.

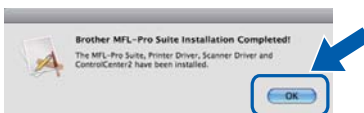

- OK!** The installation of MFL-Pro Suite is now complete. Go to step 20 on page 19.

## 20 Install Presto! PageManager

When Presto! PageManager is installed OCR capability is added to Brother ControlCenter2. You can easily scan, share and organize photos and documents using Presto! PageManager.

- a** Double-click **Presto! PageManager** and follow the on-screen instructions.

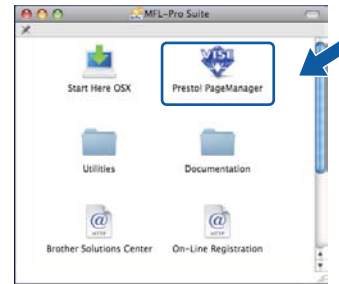

**Finish** The installation is now complete.

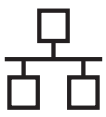

## For Wired Network Interface Users (Windows® 2000 Professional/XP/XP Professional x64 Edition/ Windows Vista®/Windows® 7)

### 17 Before you install

- a** Make sure that your computer is ON and you are logged on with Administrator rights.

#### ! IMPORTANT

- If there are any programs running, close them.
- Make sure a USB Flash memory device is not inserted into the machine.
- The screens may differ depending on the operating system.
- The supplied CD-ROM includes ScanSoft™ PaperPort™ 11SE. This software supports Windows® 2000 (SP4 or greater), XP (SP2 or greater), XP Professional x64 Edition, Windows Vista® and Windows® 7. Update to the latest Windows® Service Pack before installing MFL-Pro Suite.

#### ! IMPORTANT

**Disable all personal firewall software (other than Windows® Firewall), anti-spyware or antivirus applications for the duration of the installation.**

- b** Unplug the machine from the AC outlet.

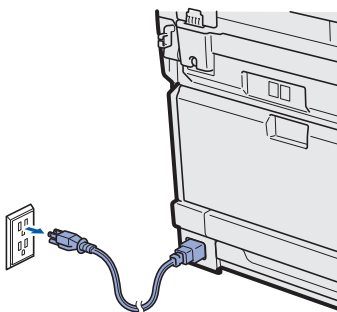

### 18 Connect the network cable

- a** Connect the network interface cable to the LAN connector marked with a  symbol and then connect it to a free port on your hub.

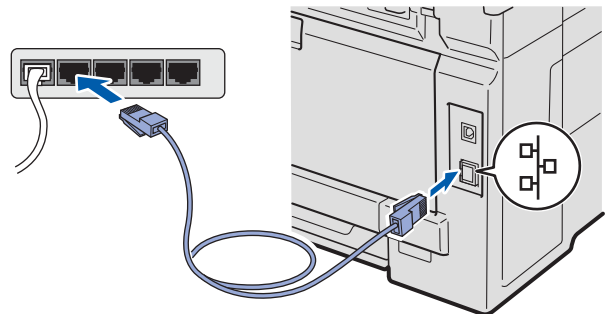

### 19 Connect the power cord

- a** Plug the AC power cord into an AC outlet. Turn the power switch on.

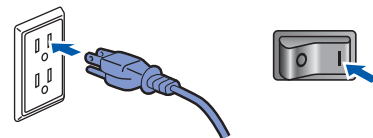

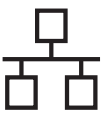

## 20 Install MFL-Pro Suite

- a** Put the supplied CD-ROM into your CD-ROM drive. If the model name screen appears, choose your machine. If the language screen appears, choose your language.

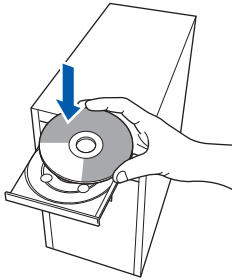

### Note

If the Brother screen does not appear automatically, go to **My Computer (Computer)**, double-click the CD-ROM icon, and then double-click **Start.exe**.

- b** The CD-ROM main menu will appear. Click **Initial Installation**.



- c** Click **Install MFL-Pro Suite**.



### Note

- If the installation does not continue automatically, open the main menu again by ejecting and then reinserting the CD-ROM or double-click the **Start.exe** program from the root folder, and continue from step **c** to install MFL-Pro Suite.
- For Windows Vista® and Windows® 7, when the **User Account Control** screen appears, click **Allow** or **Yes**.

- d** When the ScanSoft™ PaperPort™ 11SE **License Agreement** window appears, click **Yes** if you agree to the Software License Agreement.

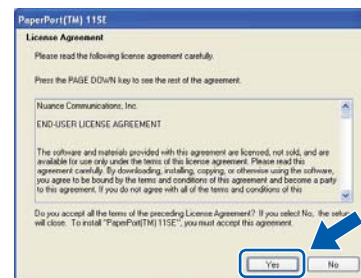

- e** The installation of ScanSoft™ PaperPort™ 11SE will automatically start and is followed by the installation of MFL-Pro Suite.

- f** When the Brother MFL-Pro Suite Software **License Agreement** window appears, click **Yes** if you agree to the Software License Agreement.



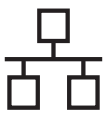

- g** Choose **Wired Network Connection**, and then click **Next**.



### Note

If you want to install the PS driver (Brother's BR-Script Driver), choose **Custom Install** and then follow the on-screen instructions. When the **Select Features** screen appears, check **PS Printer Driver**, and then continue following the on-screen instructions.

- h** For Windows® XP SP2 or greater/XP Professional x64 Edition/ Windows Vista®/ Windows® 7 users, when this screen appears, choose **Change the Firewall port settings to enable network connection and continue with the installation. (Recommended)** and click **Next**.

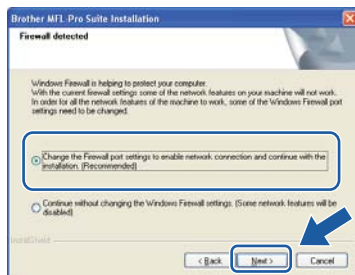

If you are not using the Windows® Firewall, see the User's Guide for your software for information on how to add the following network ports.

- For network scanning, add UDP port 54925.
- For network PC-Fax receiving, add UDP port 54926.
- If you still have trouble with your network connection, add UDP port 137.

- i** If the machine is configured for your network, choose the machine from the list, and then click **Next**.

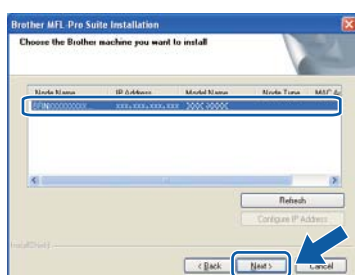

### Note

- You can find your machine's IP address and the node name by printing out the Network Configuration List. See *Print the Network Configuration List* on page 46.
- If your machine is not found over the network, the following screen will appear.



Confirm your network settings by following the on-screen instructions.

- If the IP Address of the machine is not yet configured for use on your network, the following screen appears.



Click **OK** and then **Configure IP Address**. Enter an IP address for your machine that is suitable for your network by following the on-screen instructions.

- j** If you do not want to monitor the machine status and error notification from your computer, uncheck **Enable Status Monitor** and then click **Next**.



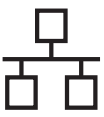

**k** The installation of the Brother drivers will automatically start. The installation screens appear one after another.

### ! IMPORTANT

**DO NOT cancel any of the screens during the installation. It may take a few seconds for all screens to appear.**

### Note

For Windows Vista® and Windows® 7, when this screen appears, click the check box and click **Install** to complete the installation correctly.

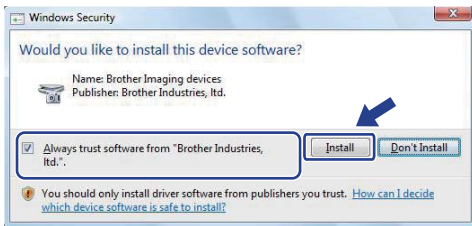

When the **On-Line Registration** screen is displayed, make your selection and follow the on-screen instructions. Once you have completed the registration process, close your web browser to return to this window. Then click **Next**.

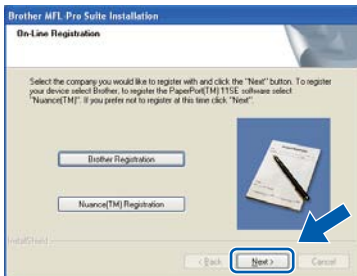

## 21 Finish and restart

**a** Click **Finish** to restart your computer. After restarting the computer, you must be logged on with Administrator rights.



### Note

If an error message appears during the software installation, run the **Installation Diagnostics** located in **Start/All Programs/Brother/MFC-XXXX LAN** (where MFC-XXXX is your model name).

**b** If this screen appears, choose the firmware update setting and click **OK**.

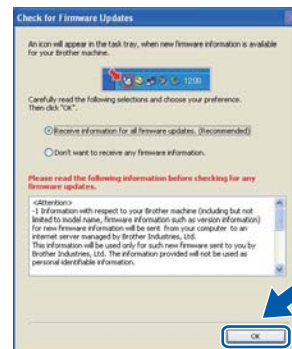

### Note

Internet access is required for the firmware upgrade.

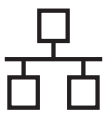

## 22

### Install MFL-Pro Suite on additional computers (if needed)

If you want to use your machine with multiple computers on the network, install MFL-Pro Suite on each computer. Go to step **20** on page 21.



#### Note

##### **Network license (Windows®)**

*This product includes a PC license for up to 5 Users. This license supports the installation of the MFL-Pro Suite including ScanSoft™ PaperPort™ 11SE on up to 5 PCs on the network. If you want to use more than 5 PCs with ScanSoft™ PaperPort™ 11SE installed, please purchase the Brother NL-5 pack which is a multiple PC license agreement pack for up to 5 additional users. To purchase the NL-5 pack, contact your authorized Brother dealer or contact Brother customer service.*

## Finish

**The installation is now complete.**



#### Note

##### **XML Paper Specification Printer Driver**

*The XML Paper Specification Printer Driver is the most suitable driver for Windows Vista® and Windows® 7 when printing from the applications that use the XML Paper Specification documents. Please download the latest driver by accessing the Brother Solutions Center at <http://solutions.brother.com/>.*



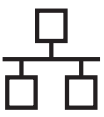

## For Wired Network Interface Users (Mac OS X 10.3.9 or greater)

### 17 Before you install

- a Make sure your machine is connected to the power and your Macintosh is ON. You must be logged on with Administrator rights.

#### ! IMPORTANT

- For the latest drivers and information on the Mac OS X you are using, visit <http://solutions.brother.com/>.
- Make sure a USB Flash memory device is not inserted into the machine.

### 18 Connect the network cable

- a Connect the network interface cable to the LAN connector marked with a  symbol and then connect it to a free port on your hub.

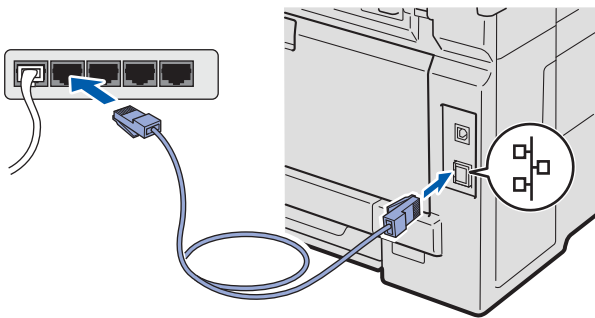

### 19 Install MFL-Pro Suite

- a Put the supplied CD-ROM into your CD-ROM drive.

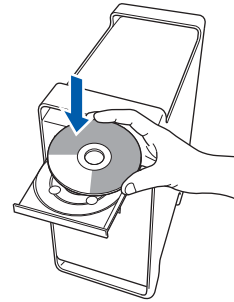

- b Double-click **Start Here OSX** to install.

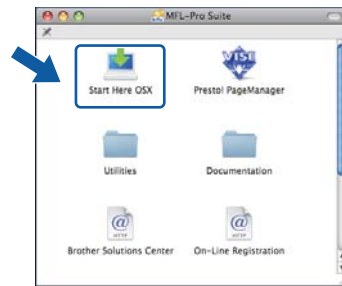

#### Note

Please see the Network User's Guide on the CD-ROM if you want to install the PS driver. (Brother's BR-Script Driver)

- c Choose **Wired Network Connection**, and then click **Next**. Follow the on-screen instructions.



#### Note

Please wait, it will take a few seconds for the software to install. (Mac OS X 10.3.9 only) After the installation, click **Restart** to finish installing the software.

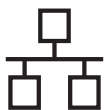

- d** The Brother software will search for the Brother device.
- e** If the machine is configured for your network, choose the machine from the list, and then click **OK**.

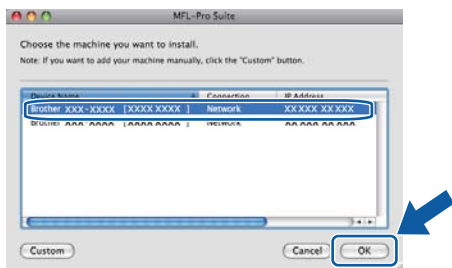

### Note

If your machine is not found over the network, confirm your network settings.

### Note

If this screen appears click **OK**.



- Enter a name for your Macintosh in **Display Name** up to 15 characters long and click **OK**. Go to **f**.

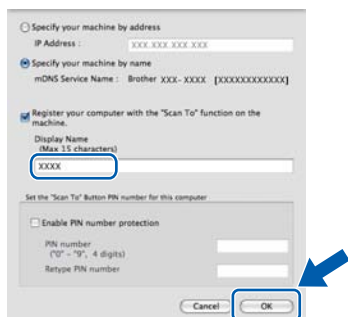

- If you want to use the machine's **Scan** key to scan over the network, you must check the **Register your computer with the "Scan To" function on the machine** box.
- The name you enter will appear on the machine's LCD when you press  and choose a scan option. (For more information, see Network Scanning in the Software User's Guide on the CD-ROM.)

- f** When this screen appears, click **OK**.

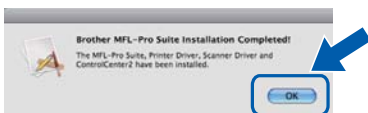

The installation of MFL-Pro Suite is now complete. Go to step **20** on page 26.

## 20 Install Presto! PageManager

When Presto! PageManager is installed OCR capability is added to Brother ControlCenter2. You can easily scan, share and organize photos and documents using Presto! PageManager.

- a** Double-click **Presto! PageManager** and follow the on-screen instructions.

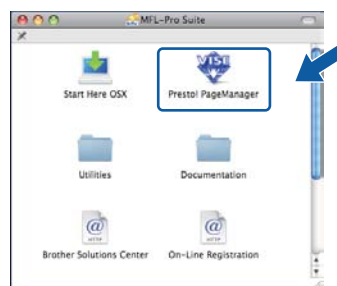

## 21 Install MFL-Pro Suite on additional computers (if needed)

If you want to use your machine with multiple computers on the network, install MFL-Pro Suite on each computer. Go to step **19** on page 25.



The installation is now complete.



## For Wireless Network Interface Users

### 17 Before you begin

First you **must** configure the wireless network settings of your machine to communicate with your network access point (router). After the machine is configured to communicate with your access point (router) computers on your network will have access to the machine. To use the machine from these computers, you will need to install the drivers and software. The following steps will guide you through the configuration and installation process.

#### Note

- To achieve optimum results with normal everyday document printing, place the Brother machine as close to the network access point (router) as possible with minimal obstructions. Large objects and walls between the two devices as well as interference from other electronic devices can affect the data transfer speed of your documents.
- Due to these factors, wireless may not be the best method of connection for all types of documents and applications. If you are printing large files, such as multi-page documents with mixed text and large graphics, you may want to consider choosing wired Ethernet for a faster data transfer or USB for the fastest throughput speed.
- Although the Brother MFC-9320CW can be used in a both wired and wireless network, only one of the connection methods can be used at a time.
- If you have previously configured the wireless settings of the machine you must reset the network (LAN) settings before you can configure the wireless settings again.  
On your machine, press **Menu**. Press **7**.  
Press **0** to choose *Network Reset*.  
Press **1** twice for *Yes* to accept the change.

#### Infrastructure Mode

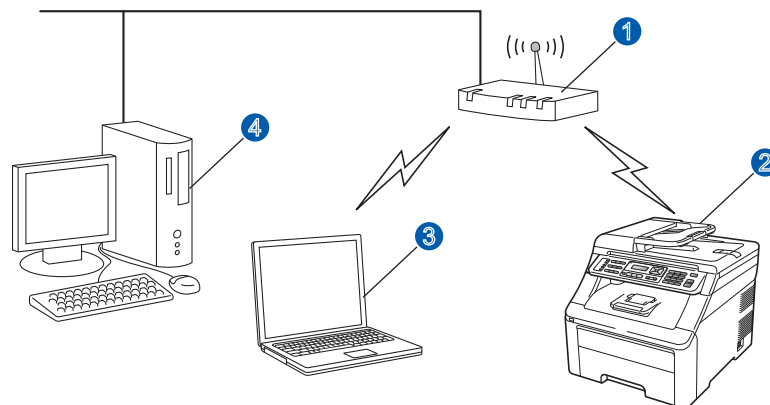

- 1 Access Point (router)
- 2 Wireless Network machine (your machine)
- 3 Wireless capable computer connected to the access point
- 4 Wired computer connected to the access point



## 18 Choose your wireless install method

The following instructions will offer three methods for installing your Brother machine in a wireless network environment. Choose the method you prefer for your environment.

### Note

To setup your machine in any other wireless environment, you can find instructions in the Network User's Guide.

### a Configuration using the Installation CD-ROM and temporarily using a USB cable (Windows® only)

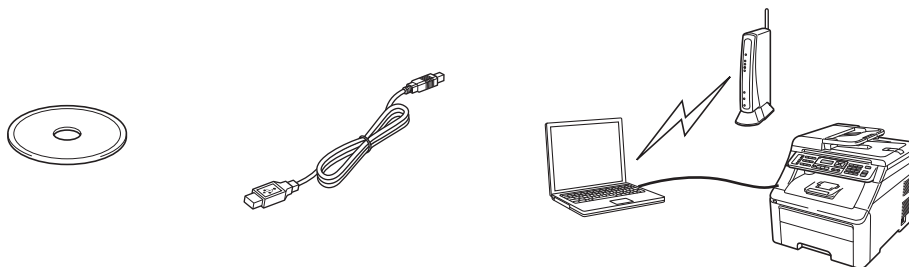

It is recommended that you use a PC wirelessly connected to your network for this method.

#### ! IMPORTANT

- You need to temporarily use a USB cable during configuration (cable not included).
- If you are using Windows® 2000, Windows® XP, or currently using a computer connected to an access point/router by network cable, you need to know your wireless settings. Please write down your wireless network settings in the area below.

Item	Record the current wireless network settings
SSID (Network Name)	
Network Key (Security Key/Encryption Key)	

\*The Network Key may also be described as the Password, Security Key or Encryption Key.

#### ! IMPORTANT

Please do not contact Brother Customer Service for assistance without the wireless security information. We cannot assist you in locating your network security settings.

### Note

- If you do not know this information (SSID and Network Key), you cannot continue the wireless setup.
- How can I find this information (SSID and Network Key)?
  1. You should see the documentation provided with your wireless access point/router.
  2. The initial network name could be the manufacturer's name or the model name.
  3. If you do not know the security information, please consult the router manufacturer, your system administrator, or internet provider.

Now go to

page 30



## b Manual configuration from the control panel

If your wireless router/access point does not support SecureEasySetup™, Wi-Fi Protected Setup or AOSS™, write down the wireless network settings of your wireless access point/router.

### ! IMPORTANT

If you do not know this information (Network Name, WEP key, WPA2-PSK (Pre-Shared Key), LEAP or EAP-FAST) you cannot continue the wireless setup. You should see the documentation provided with your access point or wireless router, consult the router manufacturer, or your system administrator.

Network name:(SSID, ESSID)			
Communication Mode	Authentication method	Encryption mode	Network key <sup>4</sup>
Infrastructure	Open system	WEP <sup>2</sup>	
		NONE	—
	Shared key	WEP <sup>2</sup>	
		WPA/WPA2-PSK <sup>1</sup>	AES
		TKIP <sup>3</sup>	
	LEAP	CKIP	
	EAP-FAST/NONE	AES	
	EAP-FAST/MS-CHAPv2	TKIP	
EAP-FAST/GTC			

<sup>1</sup> WPA/WPA2-PSK is a Wi-Fi Protected Access Pre-Shared Key, which lets the Brother wireless machine associate with access points using TKIP or AES encryption (WPA-Personal). WPA2-PSK(TKIP), WPA-PSK(TKIP or AES) uses a Pre-Shared Key (PSK) that is 8 or more characters in length, up to a maximum of 63 characters.

<sup>2</sup> The WEP key is for 64-bit encrypted networks or 128-bit encrypted networks and can contain both numbers and letters. If you do not know this information you should see the documentation provided with your access point or wireless router. This key is a 64-bit or 128-bit value that must be entered in an ASCII or HEXADECIMAL format.

#### For example:

64-bit ASCII: Uses 5 text characters

e.g. "Hello" (this is case sensitive)

64-bit Hexadecimal: Uses 10 digits of hexadecimal data

e.g. "71f2234aba"

128-bit ASCII: Uses 13 text characters

e.g. "Wirelesscomms" (this is case sensitive)

128-bit Hexadecimal: Uses 26 digits of hexadecimal data

e.g. "71f2234ab56cd709e5412aa3ba"

<sup>3</sup> This is supported for WPA-PSK only

<sup>4</sup> Encryption key, WEP key, Passphrase

For LEAP and EAP-FAST, record the User Name and Password

#### For example:

Network name:(SSID, ESSID)			
HELLO			
Communication Mode	Authentication method	Encryption mode	Network key
Infrastructure	WPA2-PSK	AES	12345678

Now go to

page 33

## c One push configuration using SecureEasySetup™, Wi-Fi Protected Setup or AOSS™

If your wireless router/access point supports automatic wireless (one-push) setup (SecureEasySetup™, Wi-Fi Protected Setup or AOSS™)

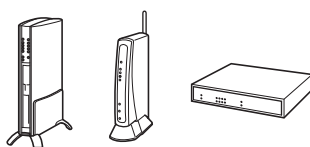

Now go to

page 35



## Configuration using the Installation CD-ROM and temporarily using a USB cable (Windows® only)

### 19 Configure the wireless settings

#### ! IMPORTANT

You need to temporarily use a USB cable during configuration (cable not included).

**a** Put the installation CD-ROM into your CD-ROM drive. If prompted, select your model and language.



#### Note

If the Brother screen does not appear automatically, go to **My Computer (Computer)**, double-click the CD-ROM icon, and then double-click **start.exe**.

**b** Click **Initial Installation** and then **Install MFL-Pro Suite**.



**c** Click Yes if you accept the license agreement. Follow the on-screen instructions.

**d** Choose **Wireless Network Connection** and then click **Next**.



#### Note

For Windows Vista® and Windows® 7, when the **User Account Control** screen appears, click **Allow** or **Yes**.

**e** For Windows® XP SP2 or greater/XP Professional x64 Edition/ Windows Vista®/ Windows® 7 users, when this screen appears, choose **Change the Firewall port settings to enable network connection and continue with the installation. (Recommended)** and click **Next**.

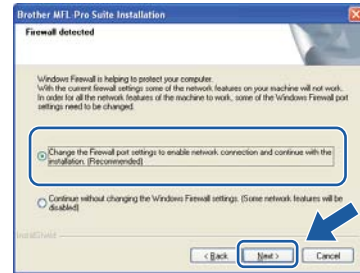

If you are not using the Windows® Firewall, see the user's guide of your firewall or antivirus software for information on how to add the following network ports.

- For network scanning, add UDP port 54925.
- For network PC-Fax receiving, add UDP port 54926.
- If you still have trouble with your network connection, add UDP port 137.

**f**

Choose **Use your computer or the control panel directly** and click **Next**.



**g**

Choose **Temporarily use a USB cable (Recommended)** and then click **Next**.

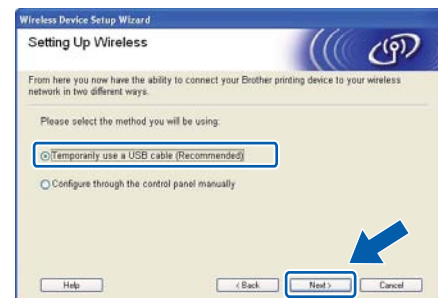



**h** If this screen appears, read the **Important Notice**. Check the box after you confirm the SSID and Network Key, and then click **Next**.



**i** Temporarily connect the USB cable (not included) directly to the computer and the machine.



**j** If the confirmation screen appears, check the box and click **Next**. When the following screen appears, check **Yes** if you want to connect with the listed SSID. Click **Next** and go to **n**.

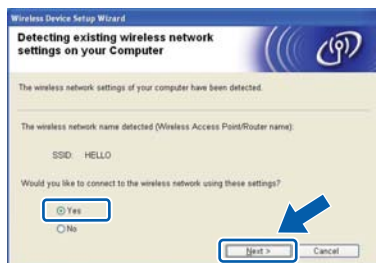

**k** The wizard will search for wireless networks available from your machine. Choose the SSID that you wrote down for your network in step **18-a** on page 28, and then click **Next**.

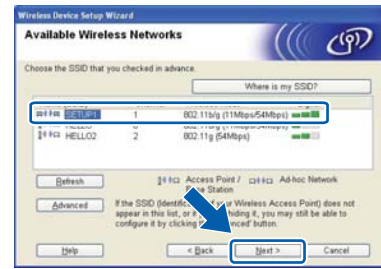

**Note**

- If the list is blank, check that the access point has power and is broadcasting the SSID, and then see if the machine and the access point are within range for wireless communication. Then, click **Refresh**.
- If your access point is set to not broadcast the SSID you can manually add it by clicking the **Advanced** button. Follow the on-screen instructions for entering the **Name (SSID)**, and then click **Next**.

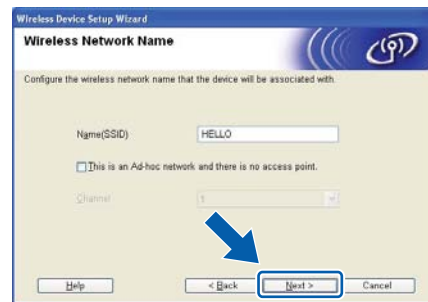

If your network is not configured for Authentication and Encryption, the following screen will appear. To continue configuration, click **OK** and go to **n**.





- m** Enter the **Network Key** you wrote down in step **18-a** on page 28 and then enter the key again in **Confirm Network Key**, then click **Next**.

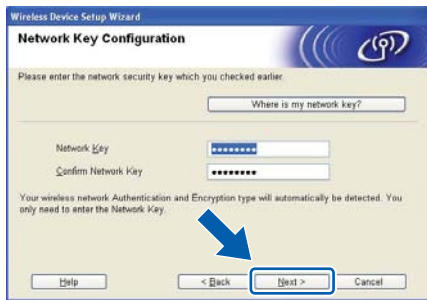

- n** Click **Next**. The settings will be sent to your machine.

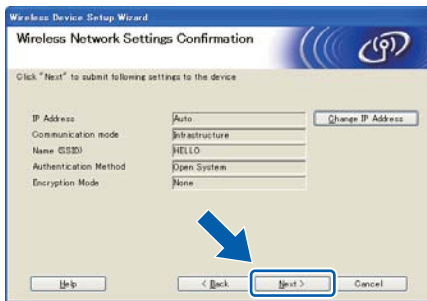

### Note

- *The settings will remain unchanged if you click **Cancel**.*
- *If you want to manually enter the IP address settings of your machine, click **Change IP Address** and enter the necessary IP address settings for your network.*
- *If the wireless setup failure screen appears, click **Retry**.*

- o** Disconnect the USB cable between the computer and the machine.



- p** Click **Next** to continue to install MFL-Pro Suite.



**Wireless setup is now complete. A four level indicator at the right of your machine's LCD will show the wireless signal strength of your access point/router.**

**To install MFL-Pro Suite, continue to step 21-j on page 39.**

**Now go to page 39**





## Manual configuration from the control panel

### 19 Configure the wireless settings

**a** On your machine, press **Menu**, **7** (Network), **2** (WLAN), **2** (Setup Wizard). Press **1** to choose On.

**b** The machine will search for available SSIDs. If a list of SSIDs is displayed, use **▲** or **▼** to choose the SSID you wrote down in step **18-b** on page 29, then press **OK**. Go to step **f**.



#### Note

*It will take several seconds to display a list of available SSIDs.*

If your access point is set to not broadcast the SSID you will have to manually add the SSID name. Go to step **c**.

**c** Press **▲** or **▼** to choose <New SSID> and press **OK**. Go to step **d**.

**d** Enter the SSID you wrote down in step **18-b** on page 29 using the dial pad to choose each letter or number.

You can use **◀** and **▶** to move the cursor left and right. For example, to enter the letter a, press the **2** key on the dial pad once. To enter the number 3, press the **3** key on the dial pad seven times.

The letters appear in this order: lower case, upper case and then numbers.  
(For more information, see *Entering Text for Wireless Settings* on page 47.)

Press **OK** when you have entered all the characters.

**e** Press **▲** or **▼** to choose Infrastructure, then press **OK**.

**f**

Use the **▲**, **▼** and **OK** keys to choose one of the options below: If your network is configured for Authentication and Encryption you must match the settings used for your network.

■ **No Authentication or Encryption:**

Choose Open System, press **OK** then choose None for Encryption Type? and press **OK**. Then press **1** for Yes to apply your settings. Go to step **k**.

■ **No Authentication with WEP Encryption:**

Choose Open System, press **OK** then use **▲** or **▼** to choose WEP for the Encryption Type? and press **OK**. Go to step **g**.

■ **Authentication with WEP Encryption:**

Choose Shared Key and press **OK**. Go to step **g**.

■ **Authentication with WPA/WPA2-PSK (TKIP or AES) Encryption:**

Choose WPA/WPA2-PSK and press **OK**. Go to step **h**.

■ **Authentication with LEAP:**

Choose LEAP, press **OK**. Go to step **i**.

■ **Authentication with EAP-FAST/NONE, EAP-FAST/MS-CHAPv2, EAP-FAST/GTC (TKIP or AES Encryption):**

Choose EAP-FAST/NONE, EAP-FAST/MSCHAP (EAP-FAST/MS-CHAPv2) or EAP-FAST/GTC, press **OK**. Go to step **j**.

**g**

Choose the appropriate key number and press **OK**. Enter the WEP key you wrote down in step **18-b** on page 29 using the dial pad to choose each letter or number.

For example, to enter the letter a, press the **2** key on the dial pad once. To enter the number 3, press the **3** key on the dial pad seven times.

The letters appear in this order: lower case, upper case and then numbers.

(For more information, see *Entering Text for Wireless Settings* on page 47.)

Press **OK** when you have entered all the characters, then press **1** for Yes to apply your settings. Go to step **k**.



**h** Press ▲ or ▼ to choose **TKIP** or **AES** for **Encryption Type?** and press **OK**. Enter the WPA/WPA2-PSK password you wrote down in step **18-b** on page 29 using the dial pad to choose each letter or number.

For example, to enter the letter **a**, press the **2** key on the dial pad once. To enter the number **3**, press the **3** key on the dial pad seven times.

The letters appear in this order: lower case, upper case and then numbers.  
(For more information, see *Entering Text for Wireless Settings* on page 47.)

Press **OK** when you have entered all the characters, then press **1** for **Yes** to apply your settings. Go to step **k**.

**i** Enter the user name and press **OK**. You can use ◀ or ▶ to move the cursor. For example, to enter the letter **a**, press the **2** key on the dial pad once.

Enter the password and press **OK**, and then press **1** to apply your settings. Go to step **k**.  
(Use the chart on *Entering Text for Wireless Settings* on page 47.)

**j** Press ▲ or ▼ to choose **TKIP** or **AES** for **Encryption Type?** and press **OK**. Enter the user name and press **OK**. You can use ◀ or ▶ to move the cursor. For example, to enter the letter **a**, press the **2** key on the dial pad once.

Enter the password and press **OK**, and then press **1** to apply your settings. Go to step **k**.  
(Use the chart on *Entering Text for Wireless Settings* on page 47.)

**k** Your machine will now try to connect to your wireless network using the information you have entered. If successful, **Connected** will appear briefly on the LCD.

If your machine does not successfully connect to your network, verify your network settings collected in step **18-b** on page 29, then repeat steps **a** to **j** to make sure you have entered the correct information.

If your access point does not have DHCP enabled you will need to manually configure the IP address, subnet mask and gateway of the machine to suit your network. See the *Network User's Guide* for details.



**Wireless setup is now complete. A four level indicator at the top of your machine's LCD will show the wireless signal strength of your access point or router.**

**To install MFL-Pro Suite, continue to step 20.**

**For Windows® Users:**

**Now go to step 20 on page 37**

**For Macintosh Users:**

**Now go to step 20 on page 42**



## One push configuration using SecureEasySetup™, Wi-Fi Protected Setup or AOSS™

### 19 Configure the wireless settings

- a** Confirm your wireless router or access point has the SecureEasySetup™, Wi-Fi Protected Setup or AOSS™ symbol as shown below.



- b** Place the Brother machine within range of a SecureEasySetup™, Wi-Fi Protected Setup or AOSS™ access point/router. The range may differ depending on your environment. Refer to the instructions provided with your access point/router.
- c** Push the SecureEasySetup™, Wi-Fi Protected Setup or AOSS™ button on your wireless router or access point. See the user's guide for your wireless router/access point for instructions.
- d** On your machine, press **Menu**, **7** (Network), **2** (WLAN), **3** (SES/WPS/AOSS).

Press **1** to choose **On**.

This feature will automatically detect which mode (SecureEasySetup™, Wi-Fi Protected Setup or AOSS™) your access point uses to configure your machine.

#### Note

If your wireless access point supports the Wi-Fi Protected Setup (PIN Method) and you want to configure your machine using the PIN (Personal Identification Number) Method, see Using the PIN Method of Wi-Fi Protected Setup in the Network User's Guide on the CD-ROM.

- e** If the LCD shows **Connected**, the machine has successfully connected to your router/access point. You can now use your machine with your wireless network.

If the LCD shows **Setting WLAN**, **Connecting SES** (Connecting WPS or Connecting AOSS), then **Connection Fail**, the machine has not successfully connected to your router/access point. Try starting from step **c** again. If the same message is indicated again, reset the machine back to the default factory settings and try again. For resetting, see *Restore the network settings to factory default* on page 46.

If the LCD shows **Setting WLAN**, then **Connection Fail** or **Connection Error**, a session overlap or connection failure was detected. The machine has detected 2 or more routers/access points on your network that have the SecureEasySetup™, Wi-Fi Protected Setup mode or AOSS™ mode enabled. Make sure that only one router/access point has the SecureEasySetup™, Wi-Fi Protected Setup mode or AOSS™ mode enabled and try starting from step **c** again.

If the LCD shows **Setting WLAN**, then **No Access Point**, the machine has not detected your router/access point on your network with the SecureEasySetup™ mode, the Wi-Fi Protected Setup mode or AOSS™ mode enabled. Move your machine close to the router/access point and try starting from step **c** again.

<i>Setting WLAN</i>	<i>Searching or accessing the access point and downloading settings from the access point.</i>
<i>Connecting SES/WPS/AOSS</i>	<i>Connecting to the access point.</i>
<i>Connection Fail</i>	<i>Connection failed.</i>
<i>Connection Error</i>	<i>A session overlap was detected.</i>
<i>Connected</i>	<i>The machine has successfully connected.</i>
<i>No Access Point</i>	<i>The access point detection failed.</i>

#### Note

If you encounter a problem during setup, temporarily place your machine closer to the wireless access point, and go back to step **c**.



**Wireless setup is now complete.**



Wireless setup is now complete. To install MFL-Pro Suite, continue to step 20.

For Windows® Users:

**Now go to**  
step 20 on page 37

For Macintosh Users:

**Now go to**  
step 20 on page 42



## Install the Drivers & Software

(Windows® 2000 Professional/XP/XP Professional x64 Edition/  
Windows Vista®/Windows® 7)

### 20 Before you install MFL-Pro Suite

**a** Make sure that your computer is ON and you are logged on with Administrator rights.

#### ! IMPORTANT

- If there are any programs running, close them.
- Make sure a USB Flash memory device is not inserted into the machine.
- The screens may differ depending on the operating system.
- The supplied CD-ROM includes ScanSoft™ PaperPort™ 11SE. This software supports Windows® 2000 (SP4 or greater), XP (SP2 or greater), XP Professional x64 Edition and Windows Vista® and Windows® 7. Update to the latest Windows® Service Pack before installing MFL-Pro Suite.

#### ! IMPORTANT

Disable all personal firewall software (other than Windows® Firewall), anti-spyware or antivirus applications for the duration of the installation.

### 21 Install MFL-Pro Suite

**a** Put the supplied CD-ROM into your CD-ROM drive. If the model name screen appears, choose your machine. If the language screen appears, choose your language.

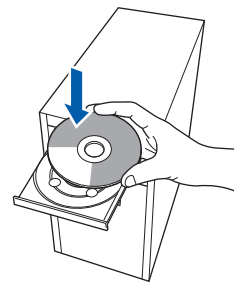

#### Note

If the Brother screen does not appear automatically, go to **My Computer (Computer)**, double-click the CD-ROM icon, and then double-click **Start.exe**.

**b** The CD-ROM main menu will appear. Click **Initial Installation**.



**c** Click **Install MFL-Pro Suite**.





## Note

- If the installation does not continue automatically, open the main menu again by ejecting and then reinserting the CD-ROM or double-click the **Start.exe** program from the root folder, and continue from step **c** to install MFL-Pro Suite.
- For Windows Vista® and Windows® 7, when the **User Account Control** screen appears, click **Allow** or **Yes**.

- d** When the ScanSoft™ PaperPort™ 11SE License Agreement window appears, click **Yes** if you agree to the Software License Agreement.

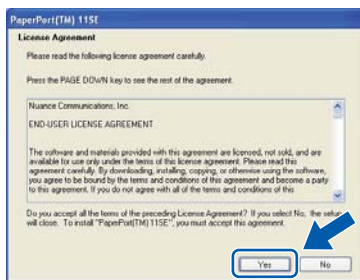

- e** The installation of ScanSoft™ PaperPort™ 11SE will automatically start and is followed by the installation of MFL-Pro Suite.

- f** When the Brother MFL-Pro Suite Software License Agreement window appears, click **Yes** if you agree to the Software License Agreement.

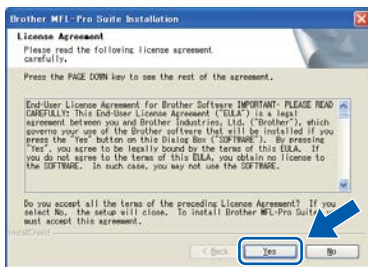

- g** Choose **Wireless Network Connection**, and then click **Next**.

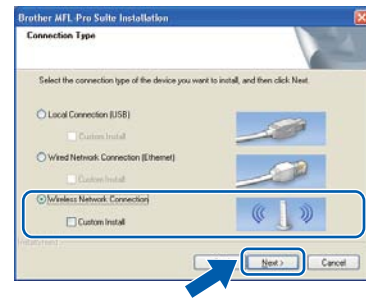

## Note

If you want to install the PS driver (Brother's BR-Script Driver), choose **Custom Install** and then follow the on-screen instructions. When the **Select Features** screen appears, check **PS Printer Driver**, and then continue following the on-screen instructions.

- h** Click on **Wireless settings checked and confirmed** check box, and then click **Next**.

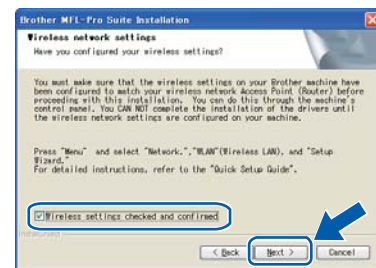



**i** For Windows® XP SP2 or greater/XP Professional x64 Edition/Windows Vista®/Windows® 7 users, when this screen appears, choose

**Change the Firewall port settings to enable network connection and continue with the installation. (Recommended)** and click **Next**.

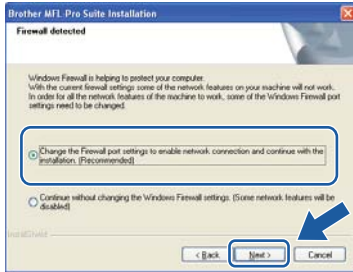

If you are not using the Windows® Firewall, see the User's Guide for your software for information on how to add the following network ports.

- For network scanning, add UDP port 54925.
- For network PC-Fax receiving, add UDP port 54926.
- If you still have trouble with your network connection, add UDP port 137.

**j** If the machine is configured for your network, choose the machine from the list, and then click **Next**.

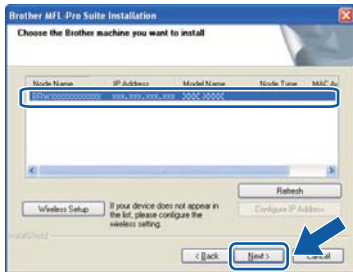

## Note

- *If your wireless settings fail, an error message will appear during the installation of MFL-Pro Suite and the installation will be terminated. Confirm your network setting by following the on-screen instruction. If you encounter this failure, please go to step 18-b on page 29 and setup the wireless connection again.*



- *If you are using WEP and the LCD displayed 'Connected' but your machine is not found, make sure you entered the WEP key correctly. The WEP key is case sensitive.*
- *If the IP Address of the machine is not yet configured for use on your network, the following screen appears.*



Click **OK** and then **Configure IP Address**. Enter an IP address for your machine that is suitable for your network by following the on-screen instructions.



**k** If you do not want to monitor the machine status and error notification from your computer, uncheck **Enable Status Monitor** and then click **Next**.

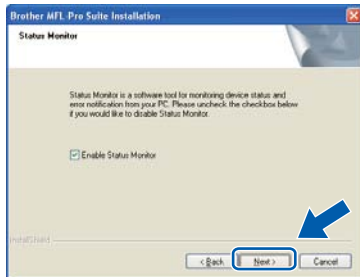

**l** The installation of the Brother drivers will automatically start. The installation screens appear one after another.

### ! IMPORTANT

**DO NOT** cancel any of the screens during the installation. It may take a few seconds for all screens to appear.

### Note

For Windows Vista® and Windows® 7, when this screen appears, click the check box and click **Install** to complete the installation correctly.



**m** When the **On-Line Registration** screen is displayed, make your selection and follow the on-screen instructions. Once you have completed the registration process, close your web browser to return to this window. Then click **Next**.

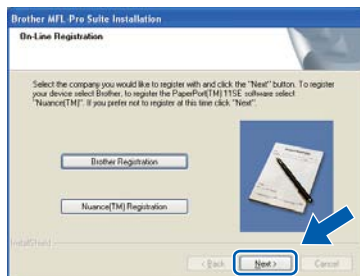

## 22 Finish and restart

**a** Click **Finish** to restart your computer. After restarting the computer, you must be logged on with Administrator rights.

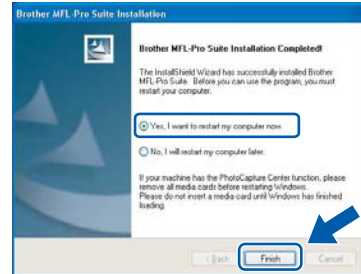

### Note

If an error message appears during the software installation, run the **Installation Diagnostics** located in **Start/All Programs/Brother/MFC-XXXX LAN** (where MFC-XXXX is your model name).

**b** If this screen appears, choose the firmware update setting and click **OK**.

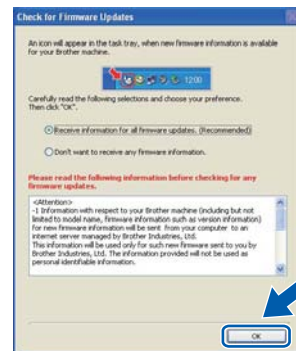

### Note

Internet access is required for the firmware upgrade.





## 23 Install MFL-Pro Suite on additional computers (if needed)

If you want to use your machine with multiple computers on the network, install MFL-Pro Suite on each computer. Go to step **20** on page 37.

### Note

#### **Network license (Windows®)**

*This product includes a PC license for up to 5 Users. This license supports the installation of the MFL-Pro Suite including ScanSoft™ PaperPort™ 11SE on up to 5 PCs on the network. If you want to use more than 5 PCs with ScanSoft™ PaperPort™ 11SE installed, please purchase the Brother NL-5 pack which is a multiple PC license agreement pack for up to 5 additional users. To purchase the NL-5 pack, contact your authorized Brother dealer or contact Brother customer service.*

## Finish

**The installation is now complete.**

### Note

#### **XML Paper Specification Printer Driver**

*The XML Paper Specification Printer Driver is the most suitable driver for Windows Vista® and Windows® 7 when printing from the applications that use the XML Paper Specification documents. Please download the latest driver by accessing the Brother Solutions Center at <http://solutions.brother.com/>.*



## Install the Drivers & Software (Mac OS X 10.3.9 or greater)

### 20 Before you install MFL-Pro Suite

- a** Make sure your machine is connected to the power and your Macintosh is ON. You must be logged on with Administrator rights.

#### ! IMPORTANT

- For the latest drivers and information on the Mac OS X you are using, visit <http://solutions.brother.com/>.
- Make sure a USB Flash memory device is not inserted into the machine.

### 21 Install MFL-Pro Suite

- a** Put the supplied CD-ROM into your CD-ROM drive.

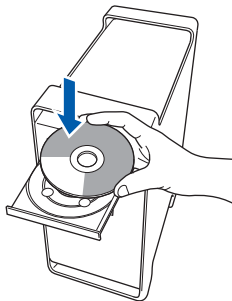

- b** Double-click **Start Here OSX** to install.



#### Note

Please see the Network User's Guide on the CD-ROM if you want to install the PS driver. (Brother's BR-Script Driver)

- c** Choose **Wireless Network Connection**, and then click **Next**.

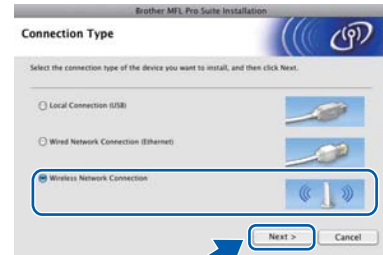

- d** Click on the **Wireless settings checked and confirmed** check box, and then click **Next**. Follow the on-screen instructions.

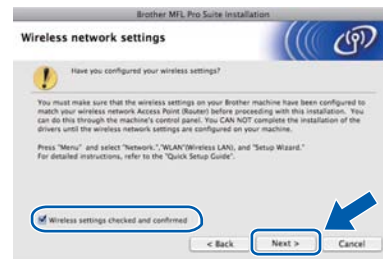

#### Note

Please wait, it will take a few seconds for the software to install. After the installation, click **Restart** to finish installing the software.

- e** The Brother software will search for the Brother device.

- f** If the machine is configured for your network, choose the machine from the list, and then click **OK**.

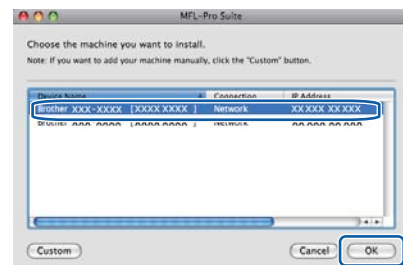



## Note

If your wireless settings fail, an error message will appear during the installation of MFL-Pro Suite and the installation will be terminated. Confirm your network setting. If you encounter this failure, go to step **18-b** on page 29 and setup the wireless connection again.

## Note

If this screen appears click **OK**.



- Enter a name for your Macintosh in **Display Name** up to 15 characters long and click **OK**. Go to step **g**.

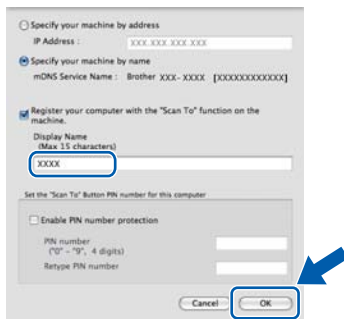

- If you want to use the machine's **Scan** key to scan over the network, you must check the **Register your computer with the "Scan To" function on the machine** box.
- The name you enter will appear on the machine's LCD when you press  and choose a scan option. (For more information, see *Network Scanning in the Software User's Guide on the CD-ROM*.)

- g** When this screen appears, click **OK**.

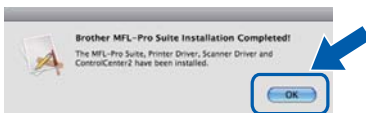

- OK!** The installation of MFL-Pro Suite is now complete. Go to step **22** on page 43.

## 22 Install Presto! PageManager

When Presto! PageManager is installed OCR capability is added to Brother ControlCenter2. You can easily scan, share and organize photos and documents using Presto! PageManager.

- a** Double-click **Presto! PageManager** and follow the on-screen instructions.

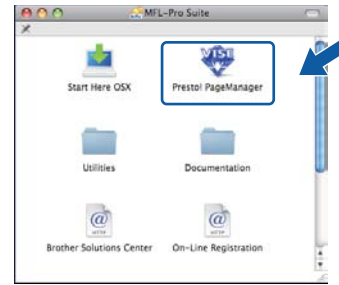

## 23 Install MFL-Pro Suite on additional computers (if needed)

If you want to use your machine with multiple computers on the network, install MFL-Pro Suite on each computer. Go to step **20** on page 42.

## Finish

The installation is now complete.

## BRAdmin Light utility (for Windows® users)

BRAdmin Light is a utility for initial setup of Brother network connected devices. It also can search for Brother products on your network, view the status and configure basic network settings, such as IP address. For more information on BRAdmin Light, visit us at <http://solutions.brother.com/>.

### Note

If you require more advanced printer management, use the latest Brother BRAdmin Professional utility version that is available as a download from <http://solutions.brother.com/>.

## Install the BRAdmin Light configuration utility

- a** Click **Network Utilities** on the menu screen.



- b** Click **BRAdmin Light** and follow the on-screen instructions.



## Set your IP address, Subnet Mask and Gateway using BRAdmin Light

### Note

If you have a DHCP/BOOTP/RARP server in your network, you do not have to do the following operation. The machine will automatically obtain its own IP address.

- a** Start BRAdmin Light. It will search for new devices automatically.



- b** Double-click the unconfigured device.

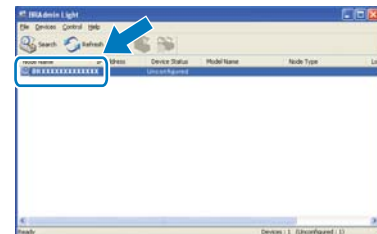

### Note

The default password for the machine is 'access'. You can use BRAdmin Light to change this password.

- c** Choose **STATIC** for the **Boot Method**. Enter the **IP Address**, **Subnet Mask** and **Gateway**, and then click **OK**.

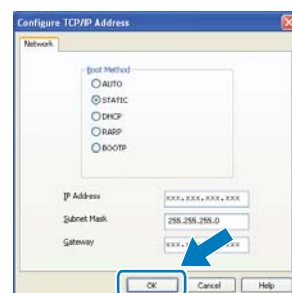

- d** The address information will be saved to the machine.

## BRAdmin Light utility (for Mac OS X users)

BRAdmin Light is a utility for initial setup of Brother network connected devices. It also can search for Brother products on your network, view the status and configure basic network settings, such as IP address from a computer running Mac OS X 10.3.9 or greater.

The BRAdmin Light software will be installed automatically when you install the printer driver. If you have already installed the printer driver, you do not have to install BRAdmin Light again. For more information on BRAdmin Light, visit us at <http://solutions.brother.com/>.

### Set your IP address, Subnet Mask and Gateway using BRAdmin Light

#### Note

- If you have a DHCP/BOOTP/RARP server in your network, you do not have to do the following operation. The machine will automatically obtain its own IP address.
- Make sure that version 1.4.2 or greater of Java™ client software is installed on your computer.
- The default password for the machine is 'access'. You can use BRAdmin Light to change this password.

- a** Double-click **Macintosh HD** on your desktop.

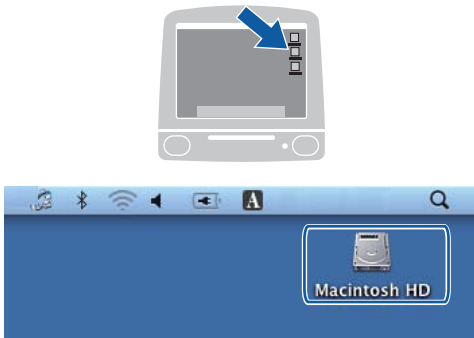

- b** Choose **Library**, **Printers**, **Brother** and then **Utilities**.

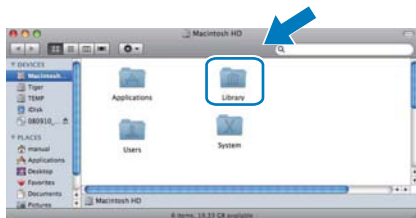

- c** Double-click the file **BRAdmin Light.jar** and run the software. BRAdmin Light will then search for new devices automatically.

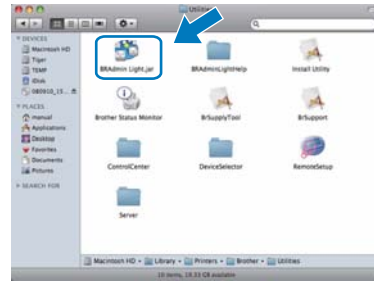

- d** Double-click the unconfigured device.

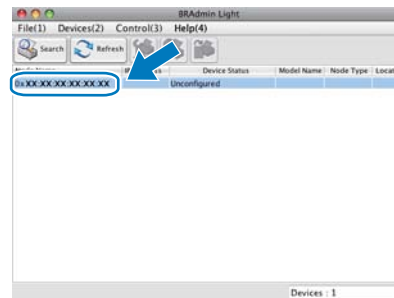

- e** Choose **STATIC** for **Boot Method**. Enter the **IP Address**, **Subnet Mask** and **Gateway**, and then click **OK**.

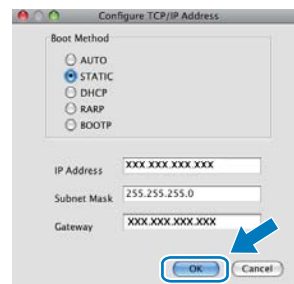

- f** The address information will be saved to the machine.

## Web Based Management (web browser)

The Brother print server is equipped with a web server that allows you to monitor its status or change some of its configuration settings, using HTTP (Hyper Text Transfer Protocol).

### Note

- The User Name is **'admin'** and the default password is **'access'**. You can use a web browser to change this password.
- We recommend Microsoft® Internet Explorer® 6.0 (or higher) or Firefox 1.0 (or higher) for Windows® and Safari 1.3 for Macintosh. Please also make sure that JavaScript and cookies are always enabled in whichever browser you use. To use a web browser, you will need to know the IP address of the print server. The IP address of the print server is listed on the Network Configuration List.

**a** Open your browser.

**b** Type `http:// printer_ip_address /` into your browser (Where "printer\_ip\_address" is the IP address of the printer or the print server name).  
■ For example `http://192.168.1.2/`



See Chapter 11 of the Network User's Guide.

## Print the Network Configuration List

You can print the Network Configuration List to confirm the current network settings. To print the Network Configuration List:

**a** Turn on the machine and wait until the machine is in the Ready state.

**b** Press **Menu, 6, 6**.

**c** Press **Start**.

The machine will print the current network settings.

## Restore the network settings to factory default

To restore all network settings of the internal Print/Scan server to factory default, please follow the steps below.

**a** Make sure the machine is not operating, then disconnect all the cables from the machine (except the power cord).

**b** Press **Menu, 7, 0**.

**c** Press **1** to choose **Reset**.

**d** Press **1** to choose **Yes**.

**e** The machine will restart, re-connect cables once this is complete.

## Entering Text for Wireless Settings

Most number keys have three or four letters printed on them. The keys for **0**, **#** and **\*** do not have printed letters because they are used for special characters.

By pressing the proper number key repeatedly, you can access the character you want.

### For configuring wireless network settings

Press Key	One time	Two times	Three times	Four times	Five times	Six times	Seven times	Eight times
<b>2</b>	a	b	c	A	B	C	2	a
<b>3</b>	d	e	f	D	E	F	3	d
<b>4</b>	g	h	i	G	H	I	4	g
<b>5</b>	j	k	l	J	K	L	5	j
<b>6</b>	m	n	o	M	N	O	6	m
<b>7</b>	p	q	r	s	P	Q	R	S
<b>8</b>	t	u	v	T	U	V	8	t
<b>9</b>	w	x	y	z	W	X	Y	Z

### Putting spaces

To enter a space in a name, press **▶** twice between characters.

### Making corrections

If you entered a letter incorrectly and want to change it, press **◀** or **▶** to move the cursor under the incorrect character, press **Clear/Back**. Re-enter the correct character. You can also back up and insert letters.

### Repeating letters

If you need to enter a letter that is on the same key as the letter before, press **▶** to move the cursor right before you press the key again.

### Special characters and symbols

Press **\***, **#** or **0**, then press **◀** or **▶** to move the cursor to the special character or symbol you want. Press **OK** to choose it.

Press **\*** for (space) ! " # \$ % & ' ( ) \* + , - . /  
Press **#** for ; < = > ? @ [ ] ^ \_ \ ~ ` | { }  
Press **0** for 0 \ { | } ~

## Options

The machine has the following optional accessory. You can expand the capabilities of the machine by adding this item. For more information about compatible SO-DIMM Memory, visit us at <http://solutions.brother.com/>.

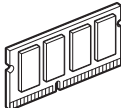

For installing the SO-DIMM Memory, see the User's Guide or visit <http://solutions.brother.com/>.

<b>SO-DIMM Memory</b>
<p>You can expand the memory by installing a (144-pin SO-DIMM) memory module.</p> 

When the time comes to replace consumable items, an error will be indicated by the LCD on the control panel. For more information about the consumables for your machine, visit us at <http://www.brother.com/original/> or contact your local Brother reseller.

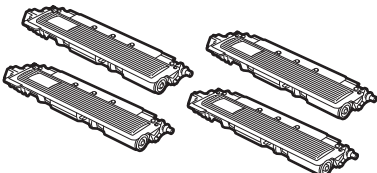
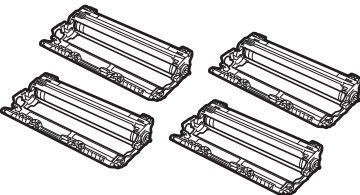
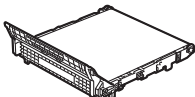
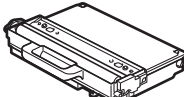
<b>Toner cartridges</b>	<b>Drum units</b>
<b>TN-210C/TN-210M/TN-210Y/TN-210BK</b>	<b>DR-210CL <sup>1</sup></b>
	
<b>Belt Unit (BU-200CL)</b>	<b>Waste Toner Box (WT-200CL)</b>
	

<sup>1</sup> Contains a set of three color drums and one black drum. All four drums are replaced at the same time.



## Trademarks

The Brother logo is a registered trademark of Brother Industries, Ltd.

Brother is a registered trademark of Brother Industries, Ltd.

Microsoft, Windows, Windows Server, Outlook and Internet Explorer are registered trademarks of Microsoft Corporation in the United States and/or other countries.

Windows Vista is either a registered trademark or a trademark of Microsoft Corporation in the United States and/or other countries.

Apple, Macintosh, Safari and TrueType are trademarks of Apple Inc., registered in the United States and other countries.

BROADCOM, SecureEasySetup and the SecureEasySetup logo are trademarks or registered trademarks of Broadcom Corporation in the United States and/or other countries.

WPA, WPA2, Wi-Fi Protected Access and Wi-Fi Protected Setup are either trademarks or registered trademarks of Wi-Fi Alliance in the United States and/or other countries.

Wi-Fi and Wi-Fi Alliance are registered trademarks of the Wi-Fi Alliance.

AOSS is a trademark of Buffalo Inc.

Nuance, the Nuance logo, PaperPort and ScanSoft are trademarks or registered trademarks of Nuance Communications, Inc. or its affiliates in the United States and/or other countries.

**Any trade names and product names of companies appearing on Brother products, related documents and any other materials are all trademarks or registered trademarks of those respective companies.**

## Compilation and Publication

Under the supervision of Brother Industries, Ltd., this manual has been compiled and published, covering the latest product descriptions and specifications.

The contents of this manual and the specifications of this product are subject to change without notice.

Brother reserves the right to make changes without notice in the specifications and materials contained herein and shall not be responsible for any damages (including consequential) caused by reliance on the materials presented, including but not limited to typographical and other errors relating to the publication.

## Copyright and License

©2009 Brother Industries, Ltd.

This product includes software developed by the following vendors:

©1983-1998 PACIFIC SOFTWARE WORKS, INC.

This product includes the "KASAGO TCP/IP" software developed by ELMIC WESCOM, Inc.

©2009 Devicescape Software, Inc.