

OWNER'S MANUAL

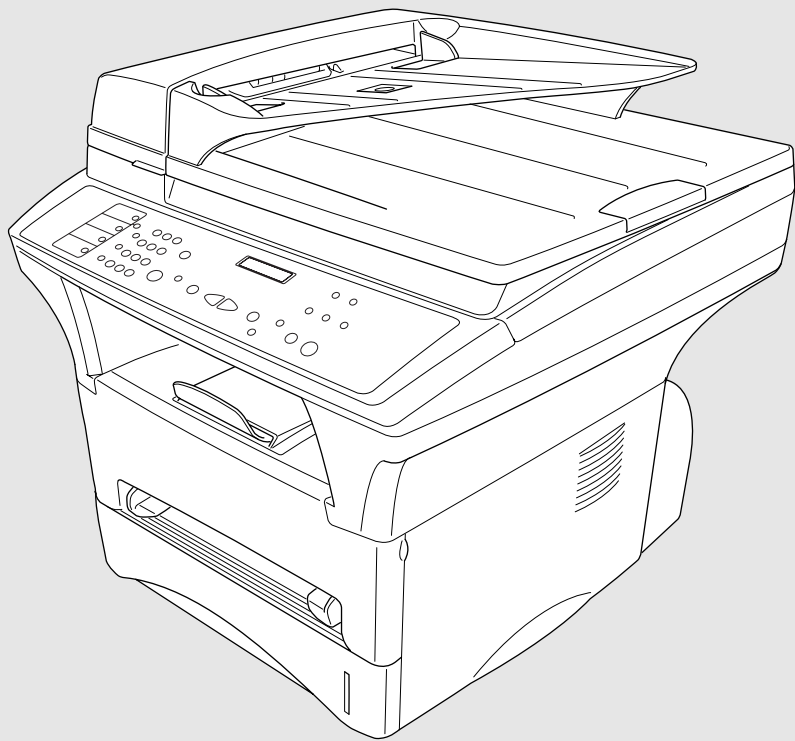

MFC-9700

.....

brother

version C

If You Need to Call Customer Service

Please complete the following information for future reference:

Model Number: MFC-9700

Serial Number*: _____

Date of Purchase: _____

Place of Purchase: _____

*** The serial number is on the back of the unit. Retain this manual with your sales receipt as a permanent record of your purchase, in the event of theft, fire or warranty service.**

Brother Numbers

IMPORTANT

For technical and operational assistance, you must call the country where you purchased the MFC. Calls must be made *from within* that country.

Brother fax-back system

Brother Customer Service has installed an easy-to-use fax-back system, so you can get instant answers to common technical questions and product information for all Brother products. This system is available 24 hours a day, 7 days a week. You can use the system to send faxes to any MFC, not just the one from which you are calling. Call and follow the voice prompts to receive faxed instructions on how to use the system and your index of fax-back subjects.

If you can't resolve a difficulty with your Brother MFC using this manual, call our fax-back system, and follow the voice prompts to receive faxed instructions about using the system and an index of fax-back subjects.

In USA: 1-800-521-2846

The Brother fax-back system number (USA only) has been preprogrammed on One Touch key **01**.

Frequently Asked Questions (FAQs)

The Brother Solutions Center is our one-step resource for all your Fax Machine/Multifunction Center needs. You can download the latest software and utilities, read FAQs and troubleshooting tips, and go to the 'Solutions' section to learn how to get the most from your Brother product.

<http://solutions.brother.com>



You can check here for Brother Printer Driver updates.

For Customer Service

In USA: 1-800-284-4329 (voice)
1-908-575-8790 (fax)
1-800-284-3238 (TTY service for the hearing-impaired)

In Canada: 1-877-BROTHER (voice)
1-514-685-4898 (fax)
1-514-685-6464 (voice) **In Montreal**

Dealers/Service Centers (USA Only)

For the name of a Brother authorized dealer or service center, call 1-800-284-4357.

Service Centers (Canada Only)

For service center address in Canada, call 1-877-BROTHER.

Ordering Accessories and Supplies

IMPORTANT

For technical and operational assistance, you must call the country where you purchased the MFC. Calls must be made *from within* that country.

For best quality results use only genuine Brother accessories, available at most Brother retailers. If you cannot find the accessory you need and you have a Visa, MasterCard, Discover or American Express credit card, you can order accessories directly from Brother. (In the USA, you can visit us online for a complete selection of Brother accessories and supplies available for purchase.)

In USA: 1-888-879-3232 (voice)
1-800-947-1445 (fax)
<http://www.brothermall.com>

In Canada: 1-877-BROTHER (voice)

Description	Item
Laser Fax Toner	TN-430 (Able to print 3000 pages) TN-460 (Able to print 6000 pages)
Laser Fax Drum	DR-400
Telephone Line Cord	LG3077001
IEEE-1284 Bi-directional Cable	F2A046-10
Power Protector for A/C Power, Phone Line Surges and Voltage Spikes (2 outlets)	QPD120
Power Protector for A/C Power, Phone Line Surges and Voltage Spikes (8 outlets)	FX120
Paper Cassette #2 (Option)	LT-400
Network (LAN) Board (Option) Brother Print/Fax Server (10/100 Base-TX Ethernet Network)	NC-8100h
Owner's Manual	LE7056001

Notice – Disclaimer of Warranties (For USA and Canada)

BROTHER'S LICENSOR(S), AND THEIR DIRECTORS, OFFICERS, EMPLOYEES OR AGENTS (COLLECTIVELY BROTHER'S LICENSOR) MAKE NO WARRANTIES, EXPRESS OR IMPLIED, INCLUDING WITHOUT LIMITATION THE IMPLIED WARRANTIES OF MERCHANTABILITY AND FITNESS FOR A PARTICULAR PURPOSE, REGARDING THE SOFTWARE. BROTHER'S LICENSOR(S) DOES NOT WARRANT, GUARANTEE OR MAKE ANY REPRESENTATIONS REGARDING THE USE OR THE RESULTS OF THE USE OF THE SOFTWARE IN TERMS OF ITS CORRECTNESS, ACCURACY, RELIABILITY, CURRENTNESS OR OTHERWISE. THE ENTIRE RISK AS TO THE RESULTS AND PERFORMANCE OF THE SOFTWARE IS ASSUMED BY YOU. THE EXCLUSION OF IMPLIED WARRANTIES IS NOT PERMITTED BY SOME STATES IN THE USA AND SOME PROVINCES IN CANADA. THE ABOVE EXCLUSION MAY NOT APPLY TO YOU.

IN NO EVENT WILL BROTHER'S LICENSOR(S) BE LIABLE TO YOU FOR ANY CONSEQUENTIAL, INCIDENTAL OR INDIRECT DAMAGES (INCLUDING DAMAGES FOR LOSS OF BUSINESS PROFITS, BUSINESS INTERRUPTION, LOSS OF BUSINESS INFORMATION, AND THE LIKE) ARISING OUT OF THE USE OR INABILITY TO USE THE SOFTWARE EVEN IF BROTHER'S LICENSOR HAS BEEN ADVISED OF THE POSSIBILITY OF SUCH DAMAGES. BECAUSE SOME STATES IN THE USA AND SOME PROVINCES IN CANADA DO NOT ALLOW THE EXCLUSION OR LIMITATION OF LIABILITY FOR CONSEQUENTIAL OR INCIDENTAL DAMAGES, THE ABOVE LIMITATIONS MAY NOT APPLY TO YOU. IN ANY EVENT BROTHER'S LICENSOR'S LIABILITY TO YOU FOR ACTUAL DAMAGES FROM ANY CAUSE WHATSOEVER, AND REGARDLESS OF THE FORM OF THE ACTION (WHETHER IN CONTRACT, TORT (INCLUDING NEGLIGENCE), PRODUCT LIABILITY OR OTHERWISE), WILL BE LIMITED TO \$50.

Compilation and Publication Notice

Under the supervision of Brother Industries Ltd., this manual has been compiled and published, covering the latest product descriptions and specifications.

The contents of this manual and the specifications of this product are subject to change without notice.

Brother reserves the right to make changes without notice in the specifications and materials contained herein and shall not be responsible for any damages (including consequential) caused by reliance on the materials presented, including but not limited to typographical and other errors relating to the publication.

BROTHER ONE YEAR LIMITED WARRANTY and EXCHANGE SERVICE (USA Only)

This warranty gives you certain rights and you may also have other rights that may vary from state to state.

This warranty is given only to the first end-use purchaser of the accompanying product (referred to in this warranty as "this Product").

What is covered: Brother warrants to you for the Warranty Period that there are no defects in the materials, workmanship or Year 2000 compliance of this Product. The "Warranty Period" is 1 year from the date you purchased this product. The "Warranty Period" for consumable items, such as Print Heads, Toner, Drums, Ink Cartridges, Print Cartridges, Refill Ribbons, Therma PLUS Paper and Thermal Paper, etc. is 90 days from the date of purchase, or the rated life of the Consumable item, whichever is shorter.

What is NOT covered: Warranty WILL BE VOID by Brother for repairs or replacements made necessary due to the following: (1) If the Product was not purchased from an authorized Brother reseller within the United States, (2) The Product has been serviced or modified by anyone other than an Authorized Service Representative of Brother, (3) The serial number has been modified, defaced or removed from this Product, (4) Non-Brother®-brand or non-Brother approved parts, supplies, power supplies or other accessories have been used with this Product, (5) Any damage caused by accident, neglect, abuse or misuse or, the recommended monthly volume has been exceeded, (6) Damages caused as a result of modification, alteration or repairs performed by anyone other than a Brother Authorized Service Representative. (7) NOT COVERED UNDER WARRANTY ARE: Consumable items, for example (including, but not limited to): ribbons, ink or toner cartridges, toner drum units, print heads, cleaning and/or instances where no defects in material or workmanship are found in the Product, etc. (8) Damage caused by improper connection and/or disconnection of the Product; failure of the operator to follow operational instructions, improper set up of the Product.

What to do if you think your Product is defective: Call our Customer Service Hotline at 1-800-284-4329, or if you suspect a defect in materials or workmanship in this Product, you can report it to a Brother Authorized Service Center. During the Warranty Period, supply Brother's

representative with a copy of your dated bill of sale showing that this Product was purchased within the United States. For the name of your Brother Authorized Service Center, call 1-800-521-2846. After contacting the Brother Authorized Service Center, you may be required to deliver or send the Product properly packaged, freight prepaid, to the Authorized Service Center together with a photocopy of your bill of sale.

What Brother will do: Brother (or its Authorized Service Center) will evaluate your report of a possible defect to determine whether a defect exists, and if it does exist, Brother (or its Authorized Service Center) will repair or (at Brother's option) replace the Product with a product that performs the same functions and performs as well as the original Product. Brother reserves the right to supply refurbished or remanufactured replacement parts provided that the replacement parts conform to the manufacturer's specifications for new products. The repaired or replacement product will be returned to you at no cost.

Exchange Service: When an exchange is authorized, Brother will exchange your non-working product with a refurbished or remanufactured product that conforms to the manufacturer's specifications for new products. The refurbished or remanufactured Product you receive will be covered by the balance of the limited warranty period remaining on the original Product, plus an additional thirty (30) days. You will keep the replacement Product that is sent to you and must return (or be billed up to the cost of a new product) your original non-working product, which shall become the property of Brother. You must call Brother Customer Service and if the representative cannot correct the product's malfunction over the telephone and you elect the exchange service, you must provide information pertaining to this Product and you must also provide a valid major credit card number. Your credit card will be charged up to the cost of a new Product if: (i) you do not return your original Product to Brother within five (5) business days; (ii) the malfunctions of your original Product are not covered by the limited warranty; (iii) the proper packaging instructions are not followed and has caused damage to the product; or (iv) the warranty period on your original Product has expired or has not been sufficiently validated with a copy of the proof of purchase (bill of sale).

BROTHER ONE YEAR LIMITED WARRANTY and EXCHANGE SERVICE (USA Only)

The Brother Customer Service Representative will ship the exchange Product via next business day delivery courier service, with return instructions and prepaid return air bill. Follow the return instructions. You must return the original Product in the same shipping carton in which the exchanged Product was received and include a copy of proof of purchase (bill of sale). Retain your original accessory items and a copy of the return air bill, signed by the courier.

Limitations: Repair or replacement as described above is your sole and exclusive (that is, your only) remedy if this Product is defective. Brother is not responsible for damage to or loss of any equipment, media, programs or data related to the use of this Product. Except for that repair or replacement, *Brother shall not be liable for any direct, indirect, incidental or consequential damages or specific relief. Because some states do not allow the exclusion or limitation of consequential or incidental damages, the above limitation may not apply to you.*

THIS WARRANTY IS GIVEN IN LIEU OF ALL OTHER WARRANTIES, WRITTEN OR ORAL, WHETHER EXPRESSED BY AFFIRMATION, PROMISE, DESCRIPTION, DRAWING, MODEL OR SAMPLE. ANY AND ALL WARRANTIES OTHER THAN THIS ONE, WHETHER EXPRESS OR IMPLIED, INCLUDING IMPLIED WARRANTIES OF MERCHANTABILITY AND FITNESS FOR A PARTICULAR PURPOSE, ARE HEREBY DISCLAIMED.

This Limited Warranty is the only warranty that Brother is giving for this Product. It is the *final expression and the exclusive and only statement* of Brother's obligations to you. It replaces all other agreements and understandings that you may have with Brother or its representatives.

This Limited Warranty (and Brother's obligation to you) may not be changed in any way unless you and Brother sign the same piece of paper in which we (1) refer to this Product and your bill of sale date, (2) describe the change to this warranty and (3) agree to make that change.

Product Support: Toll-free Customer Service and technical support is available for hardware operational assistance at 1-800-284-4329. At any time, free technical support in the form of Frequently Asked Questions, troubleshooting tips and service center locator is available through our fax-back system at 1-800-521-2846 or Brother's Internet Web Site (www.brother.com). Now you can visit us on-line at (www.brothermall.com), your complete source for genuine Brother Accessories and Supplies.

**BROTHER INTERNATIONAL CORPORATION
100 SOMERSET CORPORATE BLVD.
BRIDGEWATER, NEW JERSEY 08807-0911**

Please record your model and serial numbers and your date and location of Purchase below for your records. Keep this information with your proof of purchase (bill of sale) in case your Product is lost, stolen or requires service.

Model # _____

Serial # _____

Date of purchase: _____

Store where purchased: _____

Location of store: _____

Important: We recommend that you keep all original packing materials, in the event that you ship this product.

**BROTHER MULTIFUNCTION CENTER/FACSIMILE MACHINE
LIMITED WARRANTY
(For Canada Only)**

Pursuant to this limited warranty of 1 year from the date of purchase for labour and parts, Brother International Corporation (Canada) Ltd. ("Brother"), or its Authorized Service Centers, will repair this MFC/Facsimile machine free of charge if defective in material or workmanship. This Limited Warranty does not include cleaning, consumables (including, without limitation, print cartridges, print head, toner and drum) or damage caused by accident, neglect, misuse or improper installation or operation, any damage caused from service, maintenance, modifications, or tampering by anyone other than a Brother Authorized Service Representative, or from the use of supplies or consumable items that are non-Brother products. Operation of the MFC/Facsimile machine in excess of the specifications or with the Serial Number or Rating Label removed shall be deemed abuse and all repairs thereafter shall be the sole liability of the end-user/purchaser. In order to obtain warranty service, the MFC/Facsimile machine must be delivered or shipped freight prepaid by the end user/purchaser to a "Brother" Authorized Service Center, together with your Proof of Purchase in the form of a Sales Receipt.

For laser products: Failure to remove the Toner Cartridge (and Toner Drum Unit on applicable models) during shipping will cause severe damage to the MFC/Facsimile and will VOID the Warranty. (Refer to your Operation Manual for proper packaging.)

For ink-jet products: Do not remove the ink cartridges during shipping. Damage to your print head resulting from packing without the ink cartridges will VOID your warranty. (Refer to your Operation Manual for proper packaging.)

BROTHER DISCLAIMS ALL OTHER WARRANTIES EXPRESSED OR IMPLIED INCLUDING, WITHOUT LIMITATION, ANY IMPLIED WARRANTIES OF MERCHANTABILITY OR FITNESS FOR A PARTICULAR PURPOSE, EXCEPT TO THE EXTENT THAT ANY WARRANTIES IMPLIED BY LAW CANNOT BE VALIDLY WAIVED.

No oral or written information, advice or representation provided by Brother, its Authorized Service Centers, Distributors, Dealers, Agents or employees, shall create another warranty or modify this warranty. This warranty states Brother's entire liability and your exclusive remedy against Brother for any failure of the MFC/Facsimile machine to operate properly.

Neither Brother nor anyone else involved in the development, production, or delivery of this MFC/Facsimile machine shall be liable for any indirect, incidental, special, consequential, exemplary, or punitive damages, including lost profits, arising from the use of or inability to use the product, even if advised by the end user/purchaser of the possibility of such damages. Since some Provinces do not allow the above limitation of liability, such limitation may not apply to you.

This Limited Warranty gives you specific legal rights and you may also have other rights which vary from Province to Province.

Warranty Service is available at Brother Authorized Service Centers throughout Canada. For Technical Support or for the name and location of your nearest Authorized Service Center call 1-877-BROTHER. Within Montreal, please call (514) 685-6464. Internet support: support@brother.ca or browse Brother's Web Site: www.brother.com

Brother International Corporation (Canada) Ltd.
1 Rue Hôtel de Ville
Dollard-Des-Ormeaux, QC H9B 3H6

At your side.
brother®



Quick Reference Guide

Sending Faxes

Automatic Transmission

- 1 Place the original face up in the ADF, or face down on the scanner glass.
- 2 Enter the fax number using One Touch, Speed Dial, Search or the dial pad.
- 3 Press **Fax Start**.

Sending a Cover Page

- 1 Place the original face up in the ADF, or face down on the scanner glass.
- 2 Press **Menu, 2, 2, 8**.
- 3 When **NEXT FAX ONLY** appears, press **Set**.
- 4 Press ◀ or ▶ to select **ON** (or **OFF**), and then press **Set**.
- 5 Press ◀ or ▶ to select a comment, and then press **Set**.
- 6 Enter two digits to indicate the number of pages being sent, and then press **Set**.
- 7 Press **1** to select additional settings —**OR**—Press **2** if you are ready to fax.
- 8 Enter the fax number.
- 9 Press **Fax Start**.

Real Time Transmission

You can send faxes in real time.

- 1 Place the original face up in the ADF, or face down on the scanner glass.
- 2 Press **Menu, 2, 2, 6**.

- 3 Press ◀ or ▶ to select **ON** (or **OFF**), and then press **Set—OR—**For the next transmission only, press ◀ or ▶ to select **NEXT FAX ONLY**, and then press **Set**.
- 4 For the next fax only, press ◀ or ▶ to select **ON** (or **OFF**), and then press **Set**.
- 5 Press **1** to select additional settings —**OR**—Press **2** to fax.
- 6 Enter the fax number.
- 7 Press **Fax Start**.

Receiving Faxes

Select Receive Mode

There are three Receive modes: **FAX ONLY**, **EXT. TEL /TAD** and **MANUAL**. Press **Receive Mode** until the LCD shows your selection. After two seconds the LCD returns to the Data and Time prompt and shows the new Receive mode.

Brother fax-back system :

In USA: 1-800-521-2846

Brother Global Web Site :

<http://www.brother.com>

Frequently Asked Questions (FAQs) and Product Support:

<http://solutions.brother.com>

Brother Accessories & Supplies :

In USA: 1-888-879-3232 (voice)
1-800-947-1445 (fax)

<http://www.brothermall.com>

In Canada: 1-877-BROTHER (voice)



Storing Numbers

Storing One Touch Dial Numbers

- 1 Press **Menu**, **2**, **3**, **1**.
- 2 Press the One Touch key where you want to store the number.
- 3 Enter a number (up to 20 digits), and then press **Set**.
- 4 Enter a name (or leave it blank), and then press **Set**.
- 5 Press **Stop/Exit**.

Storing Speed Dial Numbers

- 1 Press **Menu**, **2**, **3**, **2**.
- 2 Enter a two-digit Speed Dial number, and then press **Set**.
- 3 Enter a number (up to 20 digits), and then press **Set**.
- 4 Enter a name (or leave it blank), and then press **Set**.
- 5 Press **Stop/Exit**.

Dialing Operations

One Touch Dialing / Speed Dialing

- 1 Place the original face up in the ADF, or face down on the scanner glass.
- 2 Press the One Touch key of the number you want to call—**OR**—Press **Search/Speed Dial**, press **#**, and then press the two-digit Speed Dial number.
- 3 Press **Fax Start**.

Search/Speed Dial

- 1 Place the original face up in the ADF, or face down on the scanner glass.
- 2 Press **Search/Speed Dial**, and then enter the first letter of the name you're looking for.
- 3 Press **◀** or **▶** to search the memory.
- 4 Press **Fax Start**, when the LCD shows the name you want to call.

Making Copies

Single Copy

- 1 Place the original face up in the ADF, or face down on the scanner glass.
- 2 Press **Copy**.

Sorting Multiple Copies (Using the ADF)

- 1 Place the original face up in the ADF.
- 2 Use the dial pad to enter the number of copies you want (up to 99).
- 3 Press **Options**, press **◀** or **▶** to select **OPT: STACK/SORT**, and then press **Set**.
- 4 Press **◀** or **▶** to select **SORT**, and then press **Set**.
- 5 Press **Copy**.



Table of Contents

1

Introduction.....	1-1
Using This Manual	1-1
Finding Information.....	1-1
Conventions Used in this Manual.....	1-1
Test Sheet Procedure and Product Registration (For USA Only)	1-2
To Complete Your MFC-9700 Registration On-Line (For USA Only)	1-2
MFC-9700 Control Panel Overview	1-3
About Your Machines	1-5
Custom Features	1-5
Do You Have Voice Mail on the Phone Line?	1-5
Why Should There Be Trouble?	1-5
How Can You Avoid Possible Problems?	1-5
Fax Tones and Handshake.....	1-5
ECM (Error Correction Mode).....	1-6

2

Assembly and Connections.....	2-1
Packing List.....	2-1
Choosing a Location.....	2-2
Important Safety Instructions	2-3
Release the Scanner Lock.....	2-3
Assembly.....	2-4
Installing the Drum Unit Assembly (with Toner Cartridge)	2-4
Paper.....	2-5
Acceptable Paper	2-5
Paper Capacity of Paper Cassette	2-5
Paper Specification for the Cassette	2-5
Manual Feed Slot.....	2-6
Loading Paper in the Paper Cassette	2-6
Manual Feed Slot.....	2-7
Connecting the MFC	2-8
Connections.....	2-9
Connecting an External Telephone	2-9
Connecting an External TAD (Telephone Answering Device)	2-9
Sequence	2-9
Connections.....	2-9

Recording Outgoing Message (OGM) on External TAD ...	2-10
Special Line Considerations	2-11
Roll Over Phone Lines.....	2-11
Two-Line Phone System.....	2-11
Converting Telephone Wall Outlets	2-11
Installing MFC, External Two-Line TAD, and Two-Line Telephone	2-12
Multi-Line Connections (PBX).....	2-13
If You are Installing the MFC to Work with a PBX:....	2-13
Custom Features on Your Phone Line.....	2-13

3

On-Screen Programming..... 3-1

User-Friendly Programming.....	3-1
Alternating Displays	3-1
Menu Mode	3-1
Menu Selection Table.....	3-2

4

Initial Setup..... 4-1

Getting Started.....	4-1
Setting Paper Size	4-1
Turning on Cassette #2 (Option)	4-1
Setting Cassette Usage	4-2
Setting Date and Time	4-2
Setting Station ID	4-3
Entering Text.....	4-4
Inserting Spaces	4-4
Making Corrections.....	4-4
Repeating Letters	4-4
Special Characters and Symbols	4-4
Setting the Ring Volume	4-5
Setting the Beeper Volume.....	4-5
Setting the Speaker Volume	4-5
Memory Storage	4-5
Turning On Automatic Daylight Savings Time	4-5
Toner Save.....	4-6
Sleep Mode.....	4-6
Setting Tone/Pulse Dialing Mode (For Canada Only)	4-6

5

Setup Receive..... 5-1

Receive Mode Settings.....	5-1
Select Your Receive Mode.....	5-1

To Select or Change Your Receive Mode	5-2
Setting Ring Delay	5-2
Easy Receive	5-3
Printing a Reduced Incoming Document (Auto Reduction)	5-3
Setting the Print Density.....	5-4
Advanced Receiving Operations	5-4
Operation from Extension Telephone	5-4
Changing the Fax Receive Code.....	5-4
Printing a Fax in Memory.....	5-5
Polling.....	5-5
Setting Up Polling Receive	5-5
Setting Up Sequential Polling Receive	5-6
Canceling a Scheduled Job	5-6
PC-FAX Receive Mode.....	5-6

6

Setup Send	6-1
Before You Begin.....	6-1
Sending Faxes Using Multiple Settings	6-1
Faxing from the ADF (Automatic Document Feeder)	6-1
Faxing from the Scanner Glass.....	6-3
Manual Transmission	6-4
Automatic Transmission.....	6-4
Manual and Automatic Fax Redial.....	6-4
Dual Access	6-4
Real Time Transmission.....	6-5
Checking the Jobs Status	6-5
Canceling a Job While Scanning the Original.....	6-5
Canceling a Job in Memory.....	6-6
Basic Sending Operations	6-6
Contrast.....	6-6
Fax Resolution.....	6-7
Composing Electronic Cover Page.....	6-7
Composing Your Own Comments.....	6-8
Cover Page for the Next Fax Only.....	6-8
Always Send Cover Page.....	6-9
Using a Printed Cover Page	6-9
Advanced Sending Operations	6-10
Overseas Mode	6-10
Delayed Timer	6-10
Delayed Fax.....	6-10

Delayed Batch Transmission	6-11
Setting Up for Polling Transmit	6-11

7

Auto Dial Numbers and Dialing Options	7-1
Storing Numbers for Easy Dialing	7-1
Storing One Touch Dial Numbers	7-1
Storing Speed Dial Numbers	7-2
Changing One Touch and Speed Dial Numbers.....	7-2
Setting Up Groups for Broadcasting	7-2
Dialing Options	7-3
Search	7-3
Speed Dialing	7-4
One Touch Dialing	7-4
Access Codes and Credit Card Numbers.....	7-4
Broadcasting	7-5
Pause	7-6
Fax Redial.....	7-6
Tone/Pulse (For Canada Only).....	7-6

8

Telephone Services	8-1
Custom Feature.....	8-1
Distinctive Ring.....	8-1
What Does Your Telephone Company’s	
“Distinctive Ring” Do?.....	8-1
What Does Brother’s “Distinctive Ring” Do?	8-1
Do You Have Voice Mail?.....	8-2
Before You Choose the Ring Pattern to Register	8-2
Very Important	8-3
Registering the Distinctive Ring Pattern.....	8-3
Caller ID	8-3
Viewing Caller ID List.....	8-4
Clearing a Caller ID Stored in Memory.....	8-4
Printing Caller ID List.....	8-4

9

Remote Fax Options.....	9-1
Fax Forwarding/Paging	9-1
Programming a Fax Forwarding Number.....	9-1
Programming Your Pager Number.....	9-1
Setting Fax Storage	9-2
Backup Print	9-2
Changing Remote Retrieval Access Code.....	9-3

Remote Retrieval	9-3
Using Remote Retrieval Access Code.....	9-3
Remote Commands	9-4
Retrieving Fax Messages.....	9-5
Changing Fax Forwarding Number.....	9-5

10

Printing Reports.....	10-1
MFC Settings and Activity.....	10-1
Customizing the Transmission Verification Report	10-1
Setting the Fax Activity Report Interval	10-1
Using the Reports Key.....	10-2

11

Making Copies.....	11-1
Basic Copy Operations.....	11-1
Making a Single Copy (Using the ADF).....	11-1
Making Multiple Copies (Using the ADF).....	11-1
Single or Multiple Copies (Using the Scanner Glass).....	11-2
Out of Memory Message.....	11-2
Temporary Copy Settings.....	11-3
Copying Using Multiple Settings	11-3
Using Enlarge/Reduce Key	11-3
Copy Contrast.....	11-4
Using the Options Key	11-5
Copy Mode (Type of Original).....	11-5
Sorting Multiple Copies (Using the ADF)	11-5
Special Copy Options (Using the ADF).....	11-6
Special Copy Options (Using the Scanner Glass)	11-6
2 in 1	11-6
4 in 1	11-6
Poster.....	11-7
Paper Type.....	11-8
Changing Default Copy Settings.....	11-8
Copy Mode (Type of Original).....	11-9
Copy Contrast.....	11-9
Paper Type.....	11-9

12

For DOS Users.....	12-1
How to Use the Brother MFC with Your DOS	
Application Software	12-1
What Does the Remote Printer Console Do?	12-1

Remote Printer Console Main Program.....	12-1
Installing the Remote Printer Console.....	12-2
Using the Remote Printer Console Main Program	12-3
Remote Printer Console.....	12-4
Current Printer Status Information.....	12-4
Printer Setup Category	12-4
Print Setup Section.....	12-4
Page Setup Section.....	12-5
Font Configuration.....	12-5
Other Configuration	12-6
Console Configuration Category	12-6

13

Using the Brother MFC as a Printer	13-1
Special Printing Features.....	13-1
Windows® Printing.....	13-1
Popular Printer Emulation Support	13-1
Remote Printer Console Program for DOS	13-1
Bi-directional Parallel Interface.....	13-1
Enhanced Memory Management.....	13-1
Printing From Your PC	13-2
Multi-purpose Paper Cassette.....	13-2
Two-Sided Printing (Manual Duplexing).....	13-2
Front Output Bin.....	13-3
Manual Feed Slot.....	13-3
Loading One Sheet of Paper	13-4
Loading More than One Sheet of Paper.....	13-4
Printing on Thicker Paper and Card Stock.....	13-5
Simultaneous Printing/Faxing	13-6
Choosing Acceptable Paper.....	13-6
Printer Operation Keys.....	13-7
Reset Key.....	13-7
Printing the Internal Font List	13-7
Printing the Print Configuration List.....	13-7
Restoring Factory Default Settings	13-7

14

Printer Driver Settings (For Windows® Only)	14-1
Using the Brother MFC-9700 Printer Driver	14-1
Features in the Printer Driver (For Windows® 95/98/Me and Windows® NT 4.0 Users)	14-1
Basic Tab.....	14-2
Paper Size	14-3

Multiple Page.....	14-3
Border Line.....	14-3
Orientation.....	14-3
Copies.....	14-3
Collate.....	14-4
Media Type.....	14-4
Advanced Tab	14-5
Print Quality (*1).....	14-5
Resolution	14-5
Toner Save	14-5
Print Setting (For Windows® 95/98/98SE/Me Users Only).....	14-6
Duplex Printing (*2).....	14-6
Manual Duplex.....	14-6
Binding Offset.....	14-6
Watermark (*3)	14-7
Print Watermark.....	14-7
In background	14-7
Watermark Text	14-8
Watermark Bitmap.....	14-8
Position	14-8
Page Setting (*4)	14-9
Device Options (*5)	14-10
Quick Print Setup	14-11
Administrator (For Windows® 95/98/98SE/Me Users Only)	14-11
Print Date & Time	14-12
Accessories Tab.....	14-13
Paper Source Setting.....	14-13
Default Source	14-13
Available Options	14-13
Support	14-14
Brother Solutions Center.....	14-14
Web Update.....	14-14
Check Setting.....	14-14
Features in the Printer Driver (For Windows® 2000)	14-15
General Tab	14-15
Printing Preferences	14-15
Layout Tab.....	14-16
*1 Orientation	14-16
*2 Pages Per Sheet.....	14-17

Paper/Quality Tab.....	14-17
*1 Paper Source	14-17
*2 Media	14-18
Advanced Options.....	14-18
*1 Paper /Output	14-18
*2 Graphic.....	14-19
*3 Document Options	14-19
Device Settings Tab.....	14-20
Installable Options	14-20

15

Using the Windows®-Based Brother MFL-Pro Control Center... 15-1

Brother Control Center.....	15-1
AutoLoad the Brother Control Center.....	15-1
How to Turn Off AutoLoad.....	15-2
Using the Scan Keys.....	15-2
Using the Control Panel Keys	15-2
Scan Image	15-3
Scan/OCR	15-3
Scan to E-mail	15-3
Brother Control Center Features	15-4
Auto Configuration.....	15-4
Scanning Operations.....	15-4
Copy Operations.....	15-5
PC Fax Operation	15-5
Scanner Settings for Scan, Copy and PC Fax Buttons	15-5
Global Settings	15-5
Setting Up the Scanner Configurations	15-6
To Access the Scanner Configuration Screen:	15-6
Perform an Operation from the Control Center Screen.....	15-6
Scan to File.....	15-7
Scanner Settings	15-7
Destination Folder	15-8
Scan to E-mail	15-8
Scanner Settings	15-9
E-mail Application	15-9
File Attachments.....	15-9
Conversion Options	15-10
Format	15-10
Show QuickSend Menu	15-10
QuickSend List.....	15-10
Scan to Word Processor	15-11

Scanner Settings	15-11
Word Processor	15-12
User-Defined Button	15-13
Scanner Settings	15-13
Target Application.....	15-13
Copy	15-14
Scanner Settings	15-14
Copy Settings.....	15-14
Send a Fax	15-15
Scanner Settings	15-15
Fax Settings	15-15

16

Using ScanSoft™ PaperPort® for Brother and ScanSoft™ TextBridge® (For Windows® Only).....	16-1
Using ScanSoft™ PaperPort® and TextBridge®	16-1
Viewing Items in ScanSoft™ PaperPort® for Brother	16-2
Organizing Your Items in Folders.....	16-2
Links to Many Other Applications	16-3
Using ScanSoft™ TextBridge® OCR (Converting Image Text to Text You Can Edit)	16-3
Importing Items from Other Applications.....	16-3
Exporting Items in Other Formats.....	16-4
Exporting an Image File.....	16-4
Accessing the Scanner.....	16-4
Scanning an Image into Your PC	16-5
Settings in the Scanner Window.....	16-5
Image.....	16-5
Contrast.....	16-6
Custom	16-6
PreScanning an Image	16-7

17

Setting Up and Using PC-FAX (For Windows® Only).....	17-1
Introduction	17-1
Brother Resource Manager.....	17-1
MFC Remote Setup.....	17-2
PC FAX Sending (For Windows® Only)	17-3
Setting Up User Information	17-3
Setting Up Sending.....	17-4
Outside Line Access	17-4
Include Header.....	17-4

Address Book File	17-4
Internet PC-FAX	17-4
User interface.....	17-5
Simple Style	17-5
Facsimile Style.....	17-5
Setting Up Speed Dial	17-6
The Address Book	17-7
Setting Up a Member in the Address Book.....	17-8
Setting Up a Group for Broadcasting	17-9
Editing Member Information.....	17-9
Deleting a Member or Group	17-10
Exporting the Address Book	17-10
Importing to the Address Book	17-11
Setting Up Cover Page	17-12
To	17-13
From.....	17-13
Comment.....	17-13
Select Cover Page Form.....	17-13
Import BMP file.....	17-13
Count Cover Page	17-13
Sending a File as a PC-FAX Using the Simple Style.....	17-14
Sending a File as a PC-FAX Using the Facsimile Style....	17-15
Redial	17-16
Setting Up PC-FAX Receiving (For Windows® Only).....	17-16
Setting Up Your MFC	17-16
Running PC-FAX Receiving	17-16
Setting Up Your PC.....	17-17
Viewing New PC-FAX Messages	17-17

18

Using Automatic E-Mail Printing.....	18-1
For Windows® 95, 98, 98SE, Me Only	18-1
Main Features	18-1
To Access the On-Line Documentation.....	18-1
To Install Automatic E-mail Printing (Optional Application):	18-1

19

Using the Brother MFC with a New Power Macintosh® G3, G4 or iMac™/iBook	19-1
Set up Your USB Equipped Apple® Macintosh® G3,G4, iMac™ or iBook with Mac OS 8.5/8.51/8.6/9.0/9.0.4/9.1.....	19-1

Using Brother Printer Driver with Your Apple® Macintosh®..	19-1
Sending a Fax from Your Macintosh® Application	19-3
Setting Up Your Address Book	19-5
Adding a New Member.....	19-5
Adding a New Group.....	19-6
Using Brother TWAIN Scanner Driver with Your	
Apple® Macintosh®	19-7
Accessing the Scanner.....	19-8
Scanning a Document into Your Macintosh	
G3, G4 or iMac	19-8
Settings in the Scanner Window.....	19-9
Image.....	19-9
Scanning Area.....	19-9
Business Card Size.....	19-10
Miscellaneous	19-10
Contrast	19-10
PreScanning an Image	19-11

20

Optional Accessories	20-1
Paper Cassette #2 (Option).....	20-1
Network (LAN) Board (Option)	20-1

21

Troubleshooting and Routine Maintenance	21-1
Troubleshooting	21-1
Error Messages	21-1
Original Jams and Paper Jams.....	21-3
Original is Jammed in the top of the ADF Unit	21-3
Original is Jammed inside the ADF Unit	21-3
Paper Jam.....	21-4
Paper is Jammed in the Paper Cassette.....	21-4
Paper is Jammed near the Drum Unit	21-5
Paper is Jammed in the Fuser Unit	21-5
If You Are Having Difficulty with Your MFC	21-6
Packing and Shipping the MFC	21-13
Lock the Scanner Lock.....	21-13
Routine Maintenance.....	21-16
Cleaning the Scanner.....	21-16
Cleaning the Printer.....	21-17
Cleaning the Drum Unit	21-18
Replacing the Toner Cartridge	21-18
How to Replace the Toner Cartridge.....	21-19

Replacing the Drum Unit.....	21-21
Checking the Drum Life.....	21-22

Important Information	22-1
Standard Telephone and FCC Notices	22-1
Laser Safety	22-2
FDA Regulations.....	22-2
Federal Communications Commission (FCC) Declaration of Conformity (For USA Only).....	22-3
Important.....	22-4
Industry Canada Compliance Statement (For Canada Only)	22-4
Important – About the Interface Cable	22-4
Warranty	22-4
International ENERGY STAR® Compliance Statement...	22-4
Important Safety Instructions	22-5
Trademarks.....	22-7
 Glossary.....	 G-1
 Specifications	 S-1
Product Description.....	S-1
Fax	S-1
Printer	S-2
Computer Requirements	S-3
Parallel Interface.....	S-4
USB (Universal Serial Bus) Interface	S-4
Resident Fonts	S-5
Symbol Sets/Character Sets	S-5
 Index.....	 I-1
 Remote Retrieval Access Card.....	 R-1

1 Introduction

Using This Manual

Thank you for purchasing a Brother Multi-Function Center (MFC). This MFC has been designed to be simple to use, with LCD screen prompts to guide you through programming your MFC. However, you can use your MFC to its fullest potential by taking a few minutes to read this manual.







Additionally, your MFC has a **Reports** key. Press **Reports, 1** to print a list of basic step instructions and explanations.

Finding Information

All chapter headings and subheadings are listed in the Table of Contents. You will be able to find information about a specific feature or operation by checking the Index in the back of this manual.

Conventions Used in this Manual

Throughout this manual you'll see special symbols alerting you to important information, warnings, and actions to perform. For clarification, and to help you choose the correct key presses, we've added illustrations of some of the LCD messages.

- | | |
|---|---|
| boldface | Bold typeface identifies a specific key on the MFC control panel. |
| <i>italics</i> | Italics typeface emphasize an important point, or refer you to related topic. |
| bubble dot | Bubble Dot typeface identifies the messages on the LCD of the MFC. |
|  | Warnings detail precautions you must take to avoid possible personal injury. |
|  | Cautions specify procedures you must follow or avoid to prevent possible damage to the MFC. |
|  | Notes tell you the proper response for a situation that may occur. |
|  | FYI tips provide details about how the current operation interacts with other features. |
|  | Improper Setup alerts you to devices and procedures that are not compatible with the MFC. |

Test Sheet Procedure and Product Registration (For USA Only)

After programming your Station ID, please fill out the TEST SHEET included with your MFC, and then fax it to Brother's Automated Fax Response System as your first transmission. This will verify that your MFC is properly installed. To receive a response, you must set up your Station ID. (See *Setting Station ID*, page 4-3.)

When this document is received, a confirmation sheet and Product Registration form will be sent back to your MFC. Please fill out the form and return to complete your registration.

In USA: 1-877-268-9575 (fax)

To Complete Your MFC-9700 Registration On-Line (For USA Only)

- 1** Insert the MFL Pro CD-ROM into your CD-ROM drive.
- 2** Click **On-Line Registration** to register your product on-line from the main menu.

MFC-9700 Control Panel Overview

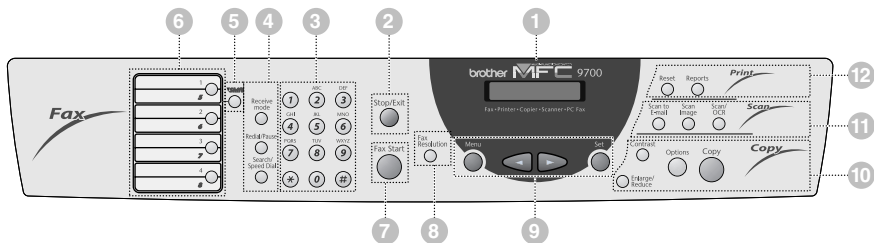

1 LCD (Liquid Crystal Display)

The LCD displays messages to help you set up and operate your MFC.

2 Stop/Exit

Stops a fax, cancels an operation, or exits from menu mode.

3 Dial Pad

Dials phone and fax numbers, and can be used as a keyboard for entering information into the MFC.

(For Canada only): The # key lets you switch the dialing type during a telephone call from **PULSE** to **TONE**.

4 Receive and Dialing Keys: Receive mode

Use to select how the MFC will handle incoming calls.

Redial / Pause

Redials the last number that was called. Also inserts a pause in auto dial numbers.

Search/Speed Dial

Lets you look up numbers stored in the dialing memory. Also lets you dial stored phone numbers by pressing a # plus a two-digit number.

5 Shift

To access memory locations 5 through 8 in the One Touch keys hold down the Shift key.

6 One Touch Keys

These 4 keys give you instant access to 8 previously stored auto dial numbers.

7 Fax Start

Starts an operation, such as sending a fax.

8 Fax Resolution

Sets the resolution when you send a fax.

9 Programming Keys:

Menu

Lets you access the menu and programing mode.

◀ (Left Arrow)

▶ (Right Arrow)

Moves the LCD cursor through text and options.

Set

Stores a menu setting in the MFC. Also used for sending one fax to multiple numbers. (For details, see *Broadcasting*, page 7-5.)

10 Copy Keys (Temporary Settings):

Enlarge/Reduce

Lets you reduce or enlarge copies depending upon the ratio you select.

Contrast

Lets you make a copy that is lighter or darker than the original.

Options

You can quickly and easily change your temporary settings for each copy.

Copy

Makes a copy.

11 Scanner Keys:

Scan to E-mail

Press this key to start scanning an original into your E-mail application, setting it up automatically as an attachment.

Scan Image

Press this key to scan a color picture into your graphics application for viewing and editing.

Scan/OCR

Press this key to start scanning a text document. ScanSoft™ TextBridge® will convert it to editable text and display it in your word processor application for further editing.

12 Printer Keys:

Reset

Clears data from the printer memory.

Reports

Access the Reports menu so you can select reports to print:
Help List, Auto Dial, Fax Activity, Transmission Verification and User Settings.

About Your Machines

If you're a first-time MFC user, fax operation might seem a little mysterious. Soon, you'll recognize the unusual fax tones on your phone line, and be able to send and receive faxes easily.

Custom Features

Do You Have Voice Mail on the Phone Line?

If you have Voice Mail on the phone line on which you will install your new MFC, *there is a strong possibility that Voice Mail and the MFC will conflict with each other while receiving incoming calls.*

Why Should There Be Trouble?

Since both machines and Voice Mail pick up the line at the number of rings you have set, each of them has the ability to keep the other from receiving calls. For example, if your Voice Mail is set to answer after two rings and your MFC is set to answer after four, your Voice Mail will keep your MFC from receiving faxes. If you set Voice Mail and the Brother MFC to answer at the same number of rings, there is no way of knowing which one will answer first. It is important to remember that neither Voice Mail nor the MFC can pass the call back to the other after the call has been answered.

How Can You Avoid Possible Problems?

A very good way to avoid problems like the one mentioned previously is *to get a second phone number on your present phone line.* Many people with Voice Mail opt for this choice, which is called "Distinctive Ring", and they are very satisfied with it. *For details about this type of custom service, please See Distinctive Ring, page 8-1.*

Another way to avoid possible problem is to replace your Voice Mail with an answering MFC. Your Brother MFC is designed to work in tandem with an answering MFC or TAD (telephone answering device). (See *Connecting an External TAD (Telephone Answering Device)*, page 2-9.)

Fax Tones and Handshake

When someone is sending a fax, the MFC sends fax calling tones (CNG tones)—soft, intermittent beeps at 4-second intervals. You'll hear them after you dial and press **Fax Start**; they continue for about 60 seconds after dialing. During that time, the sending MFC must begin the "handshake" with the receiving machine. Each time you use automatic procedures to send a fax, you are sending CNG tones over the phone line. You'll soon learn to listen for these soft beeps each time you answer a phone on your fax line, so you will know if you are receiving a fax message.

The receiving fax responds with fax receiving tones—loud, chirping sounds. A receiving fax chirps for about 60 seconds over the phone line, and the LCD shows **RECEIVING**. If your MFC is set to the FAX mode, it will answer every call automatically with fax receiving tones. Even if the other party hangs up, your MFC continues to send the “chirps” for about 60 seconds, and the screen continues to show **RECEIVING**.

The fax “handshake” is the time in which the sending machine’s CNG tones and the receiving machines “chirps” overlap. This must be for at least 2 to 4 seconds, so the fax machines can understand how each is sending and receiving the fax. The handshake cannot begin until the call is answered, and the CNG tones last for only about 60 seconds after the number is dialed. Therefore, it’s important for the receiving MFC to answer the call in as few rings as possible.



When you have an external telephone answering device (TAD) on your fax line, your TAD will determine the number of rings before the call is answered. Pay special attention to the directions for connecting a TAD to your MFC in Chapter 2, *Assembly and Connections*.

ECM (Error Correction Mode)

ECM is a way for the MFC to check the integrity of a fax transmission while it is in progress. ECM transmissions are possible only between machines that both have the ECM feature. If they do, you may send and receive fax messages that are continuously checked for their integrity. Sufficient memory must be available in your MFC for this feature to work.

2

Assembly and Connections

Packing List

Make sure you have the following items:

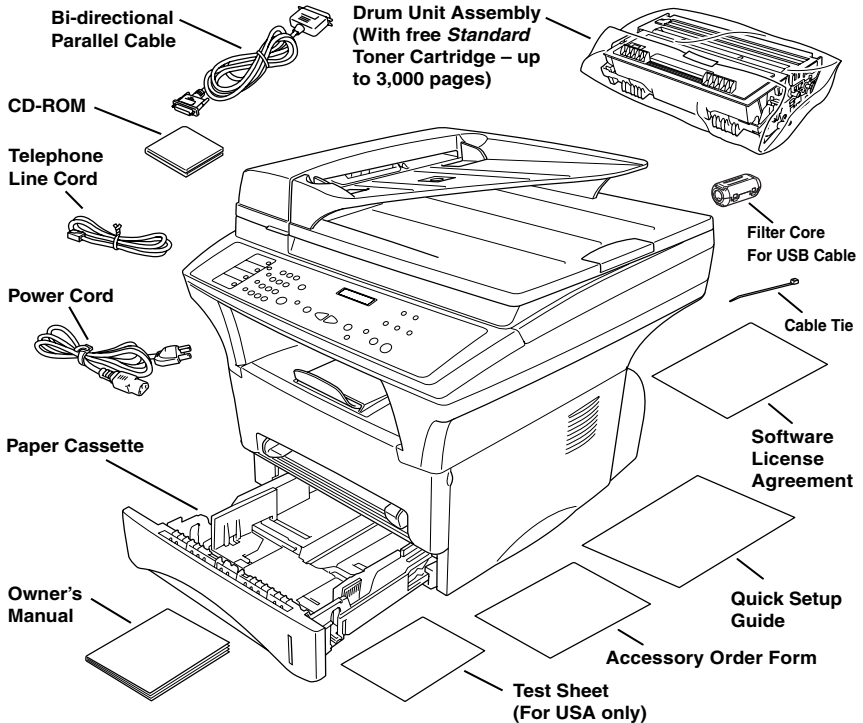

If an item is missing, call Brother Customer Service at 1-800-284-4329 (in USA), 1-877-BROTHER (in Canada) or 1-514-685-6464 (in Montreal). See *Ordering Accessories and Supplies*, page ii for the correct item numbers.



Whenever you transport the MFC, use the packing materials that came with your MFC. If you do not pack the MFC correctly, you may void your warranty.

Choosing a Location

Place your MFC on a flat stable surface, such as a desk. Select a place that is free of vibration and shocks. Place the MFC near a telephone jack and a standard, grounded power outlet. Choose a location where the temperature remains between 50°F and 90.5°F (10°–32.5°C).

- ⊘ Avoid placing your MFC in a high-traffic area. Do not place near heaters, air conditioners, water, chemicals, or refrigerators. Do not expose the MFC to direct sunlight, excessive heat, moisture, or dust. Do not connect your MFC to electrical outlets controlled by wall switches or automatic timers. Disruption of power can wipe out information in the MFC's memory. Do not connect your MFC to electrical outlets on the same circuit as large appliances or other equipment that might disrupt the power supply. Avoid interference sources, such as speakers or the base units of cordless phones.



⚠ WARNING

- Use caution when installing or modifying telephone lines. Never touch telephone wires or terminals that are not insulated unless the telephone line has been disconnected at the wall jack. Never install telephone wiring during a lightning storm. Never install a telephone jack in a wet location unless the jack is specifically designed for a wet location.
- Lightning and power surges can damage this product! We recommend that you use a quality surge protection device on the AC power line and on the telephone line, or unplug the lines during a lightning storm.
- For PLUG CABLE EQUIPMENT, the socket-outlet should be installed near the equipment and should be easily accessible.
- To reduce the risk of shock or fire, use only a No. 26 AWG or larger telecommunication line cord.

Important Safety Instructions

When using your telephone equipment, basic safety precautions should always be followed to reduce the risk of fire, electric shock and injury to persons, including the following:

- 1 Do not use this product near appliances that use water, in a wet basement or near a swimming pool.
- 2 Avoid using a telephone during an electrical storm. There may be a remote risk of electric shock from lightning.

Release the Scanner Lock

Push the blue Scanner Lock Lever up to unlock the scanner. This lever is located on the rear left underside of the scanner cover.

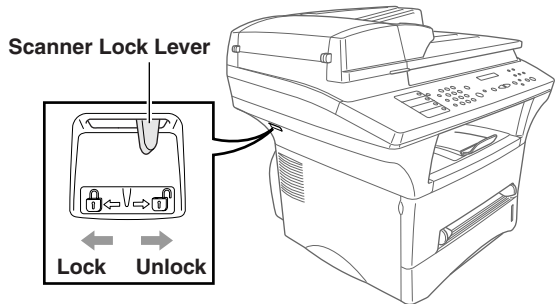

! Caution

If the message **CHECK SCAN LOCK** appears on the LCD, unlock the scanner immediately, and then press **Stop/Exit**.

Assembly

Installing the Drum Unit Assembly (with Toner Cartridge)

- 1 Unpack the drum unit assembly including the toner cartridge, and gently rock it from side to side five or six times to distribute the toner evenly inside the cartridge.

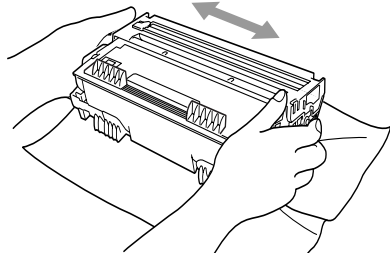

- !** To prevent damage to the drum, do not expose it to light for longer than a few minutes.

- 2 Open the front cover of the MFC.

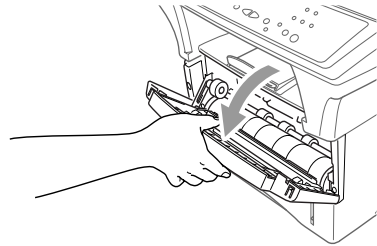

- 3 Insert the drum unit assembly into the MFC.

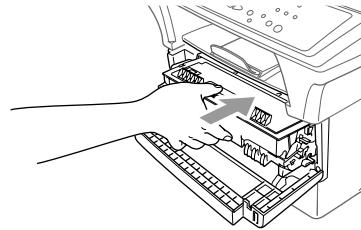

- 4 Close the front cover.

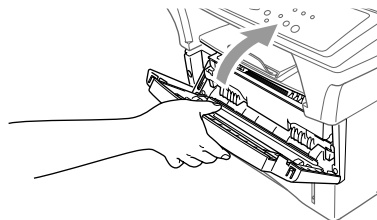

Paper

Acceptable Paper

	Paper Type	Paper Size
Paper Cassette #1:	cut sheet	Letter, Legal, A4, A5, ISO B5, Executive, A6
Manual Feed Slot:	cut sheet	Letter, Legal, A4, A5, B5 (JIS/ISO), Executive, A6, 2.75–8.5 × 4.57–14 inches (70–216 × 116–356 mm)
	envelopes	COM-10, Monarch, C5, DL
	post cards	—
	labels and transparencies	Letter, A4



We Recommend:

Cut sheet:	Xerox 4200DP 20 lb, Champion Paper One 20 lb, Hammermill Laser Paper 24 lb
Labels:	Avery <i>laser</i> label #5160
Transparencies:	3M CG3300 for <i>laser</i> printers or equivalent

Paper Capacity of Paper Cassette

Paper Cassette #1:	Max. paper height is 1.06 inches (27 mm) (use the guides) or approx. 250 sheets of 20 lb. (75 g/m ²) Letter/A4 paper, 10 transparencies.
Front Output Bin:	Approx. 150 sheets of 20 lb. (75 g/m ²) Letter/A4 paper

Paper Specification for the Cassette

	Cut Sheet
Basis Weight:	16 to 28 lb. (60 to 105 g/m ²)
Caliper:	0.003 to 0.005 inches. (0.08 to 0.13 mm)
Moisture Content:	4% to 6% by weight

Manual Feed Slot

	Cut Sheet	Envelopes
Basis Weight:	16 to 43 lb. (60 to 161 g/m ²)	20 to 24 lb. (75 to 90 g/m ²)
Caliper:	0.003 to 0.008 inches. (0.08 to 0.2 mm)	0.003 to 0.005 inches. (0.084 to 0.14 mm)
Moisture Content:	4% to 6% by weight	4% to 6% by weight



Fax messages can be received on Letter, Legal and A4 size paper.
If you use legal or A4, change the Paper Size setting: (**Menu, 1, 1**)

Loading Paper in the Paper Cassette

- 1 Pull the paper cassette completely out of the MFC.

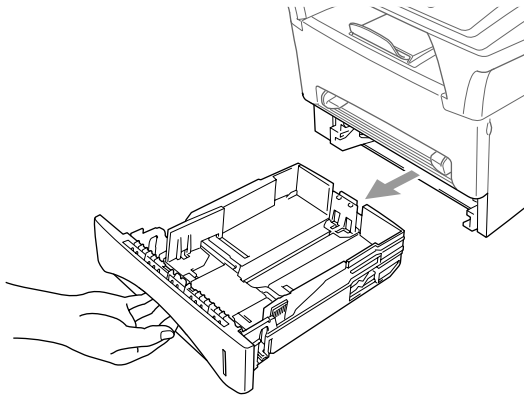

- 2 Slide the paper width and length adjusters to the position for the paper size you are using.

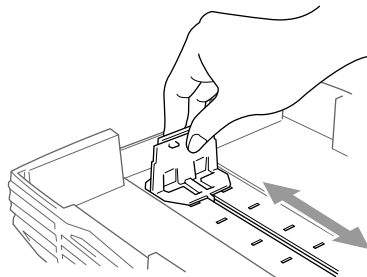
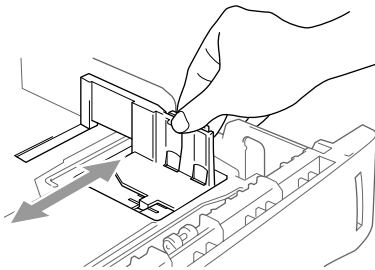

- 3 Fan the paper well. Load paper in the paper cassette. Press down on the paper to flatten it in all four corners, keeping the paper level below the guide. The cassette can hold up to 250 sheets of 20 lb (75g/m²) paper.

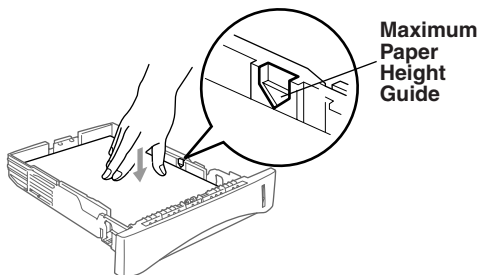

- 4 Slide the paper cassette into the MFC until it locks into place.

Manual Feed Slot

Use the manual feed slot to print or copy on envelopes, labels, transparencies, card stock or thicker paper:

The manual feed slot is above the paper cassette. Load paper or envelopes *one at a time*. You do not have to remove paper from the paper cassette.

You do not have to choose Manual Feed in the Setup dialog box of your printer driver. Insert the sheet of paper for Portrait (vertical) or Landscape (horizontal), with the side you wish to print on face up in the manual feed slot.

- 1 Align the paper at the center of the manual feed slot and insert the paper into the manual feed slot until the front edge of the paper touches the paper feed roller.
- 2 Adjust the paper guides to the width of the paper.

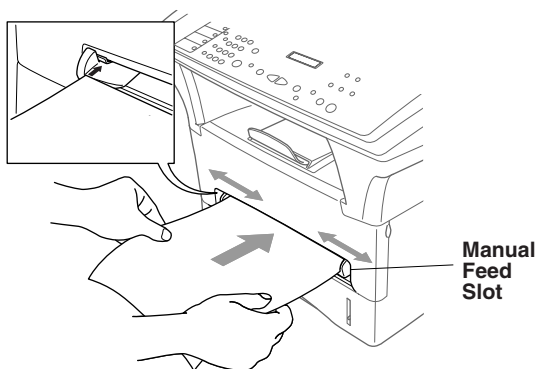

Connecting the MFC

- 1 Connect the power cord.
- 2 Connect the telephone line cord.

Connect one end of the telephone line cord to the line jack on the MFC and the other end to a modular wall jack.

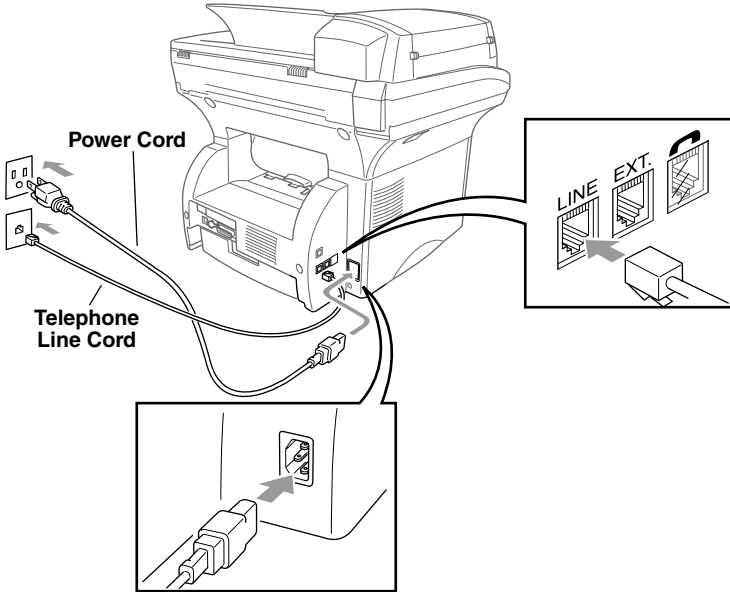

! WARNING

- The MFC must be grounded using a 3-prong plug.
- Since the MFC is grounded through the power outlet, protect yourself from potentially hazardous electrical conditions on the telephone line by keeping the power to your MFC on when you connect it to a telephone line. When you want to move your MFC, protect yourself by disconnecting the telephone line first, and then the power cord.
- Lightning and power surges can damage this product! We recommend that you use a quality surge protection device on the AC power line as well as on the telephone line, or unplug the lines during a lightning storm.
- Do not touch the rollers at the paper exit.

Connections

Connecting an External Telephone

Although your MFC does not have a handset, you can connect a separate telephone (or telephone answering device) directly to the MFC.

Connect the modular plug on the telephone's line cord to the jack labeled EXT. on the left side of the MFC.

Whenever this phone (or TAD) is in use, the LCD shows **TELEPHONE**.

Connecting an External TAD (Telephone Answering Device)

Sequence

You might choose to connect an answering system. However, when you have an **external TAD** on the same telephone line as the MFC, the TAD answers all calls. The MFC "listens" for fax calling (CNG) tones. If it hears them, the MFC takes over the call and receives the fax. If it doesn't hear CNG tones, the MFC lets the TAD continue playing your outgoing message so your caller can leave you a voice message.

The TAD must answer within five rings (the recommended setting is two rings). The MFC cannot hear CNG tones until the TAD has answered the call, and with five rings there are only 8–10 seconds of CNG tones left for the fax "handshake." Make sure you carefully follow the instructions in this manual for recording your outgoing message. We do not recommend using the toll saver feature on your external answering machine if it exceeds five rings.



If you do not receive all your faxes, you must reset the setting on your external TAD to four rings.

Connections

The external TAD must be plugged into the left side of the MFC in the jack labeled EXT. Your MFC cannot work properly if you plug the TAD into a wall jack.



If You Subscribe to your Telephone Company's Distinctive Ring Service:

You may connect an external TAD to a separate wall jack *only* if you subscribe to your telephone company's Distinctive Ring service, have registered the distinctive ring pattern on your MFC, use that number as a fax number and have set your MFC's Receive mode to **MANUAL**. The recommended setting is three or four rings on the external TAD when you have the telephone company's Distinctive Ring service.



If You Do NOT Subscribe to Distinctive Ring Service:

You must plug your TAD into the EXT. jack of your MFC. If your TAD is plugged into a wall jack, both your MFC and the TAD will try to control the phone line. (See *illustration* on page 2-10.)

 **Do not connect a TAD elsewhere on the same phone line.**

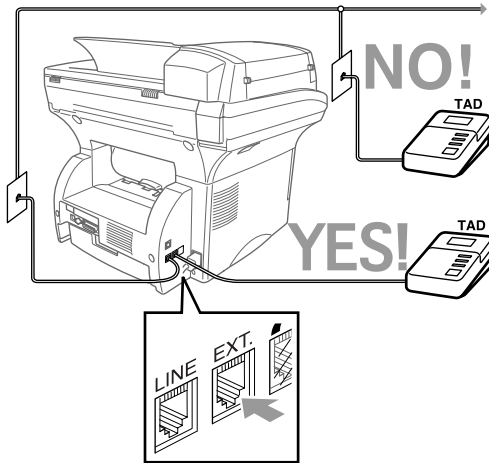

- 1 Plug the telephone line cord from the wall jack into the left side of the MFC, in the jack labeled LINE.
- 2 Plug the telephone line cord from your TAD into the left side of the MFC, in the jack labeled EXT. (Make sure this cord is connected to the TAD at the TAD's telephone line jack, and not its telephone set jack.)
- 3 Set your external TAD to four rings or less. (The MFC's Ring Delay setting does not apply).
- 4 Record the outgoing message. (See below.)
- 5 Set the Receive mode to EXT.TEL/TAD (page 5-1).

Recording Outgoing Message (OGM) on External TAD

Timing is important in recording this message. The message sets up the ways to handle both manual and automatic fax reception.

- 1 Record 5 seconds of silence at the beginning of your message. (This allows your MFC time to listen for the fax CNG tones of automatic transmissions before they stop.)
- 2 Limit your speaking to 20 seconds. (See *Easy Receive*, page 5-3.)
- 3 End your 20-second message by giving your Fax Receive Code for people sending manual faxes. For example: **“After the beep, leave a message or send a fax by pressing * 5 1 and Start.”**



We recommend beginning your OGM with an initial 5-second silence because the MFC cannot hear fax tones over a resonant or loud voice. You may try omitting this pause, but if your MFC has trouble receiving, then you must rerecord the OGM to include it.

Special Line Considerations

Roll Over Phone Lines

A roll over phone system is a group of two or more separate telephone lines that pass incoming calls to each other if they are busy. The calls are usually passed down or “rolled over” to the next available phone line in a preset order.

Your MFC can work in a roll over system as long as it is the last number in the sequence, so the call cannot roll away. Do not put the MFC on any of the other numbers; when the other lines are busy and a second fax call is received, the fax call would be transferred to a line that does not have a fax machine. **Your MFC will work best on a dedicated line.**

Two-Line Phone System

A two-line phone system is nothing more than two separate phone numbers on the same wall outlet. The two phone numbers can be on separate jacks (RJ11) or combined into one jack (RJ14). Your MFC must be plugged into an RJ11 jack. RJ11 and RJ14 jacks may be equal in size and appearance and both may contain four wires (black, red, green, yellow). To test the type of jack, plug in a two-line phone and see if it can access both lines. If it can, you must separate the line for your MFC.

Converting Telephone Wall Outlets

There are three ways to convert to an RJ11 receptacle. The first two ways may require assistance from the telephone company. You can change the wall outlets from one RJ14 jack to two RJ11 jacks. Or, you can have an RJ11 wall outlet installed and slave or jump one of the phone numbers to it.

The third way is the easiest: Buy a triplex adapter. You can plug a triplex adapter into an RJ14 outlet. It separates the wires into two separate RJ11 jacks (Line 1, Line 2) and a third RJ14 jack (Lines 1 and 2). If your MFC is on Line 1, plug the MFC into L1 of the triplex adapter. If your MFC is on Line 2, plug it into L2 of the triplex adapter.

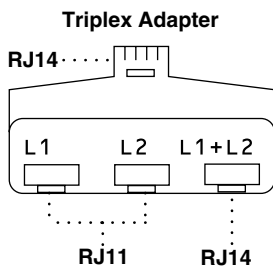

Installing MFC, External Two-Line TAD, and Two-Line Telephone

When you are installing an **external** two-line telephone answering device (TAD) and a two-line telephone, your MFC must be isolated on one line at both the wall jack and at the TAD. *The most common connection is to put the MFC on Line 2, which is our assumption in the following steps.* The back of the two-line TAD must have two telephone jacks: one labeled L1 or L1/L2, and the other labeled L2. You will need at least three telephone line cords, the one that came with your MFC and two for your external two-line TAD. You will need a fourth line cord if you add a two-line telephone.

- 1 Place the two-line TAD and the two-line telephone next to your MFC.
- 2 Plug one end of the telephone line cord for your MFC into the L2 jack of the triplex adapter. Plug the other end into the **LINE** jack on the left side of the MFC.
- 3 Plug one end of the first telephone line cord for your TAD into the L1 jack of the triplex adapter. Plug the other end into the L1 or L1/L2 jack of the two-line TAD.
- 4 Plug one end of the second telephone line cord for your TAD into the L2 jack of the two-line TAD. Plug the other end into the **EXT.** jack on the left side of the MFC.

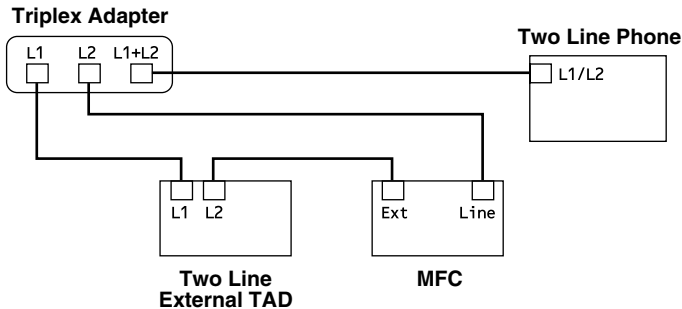

You can keep two-line telephones on other wall outlets as always. There are two ways to add a two-line telephone to the MFC's wall outlet. You can plug the telephone line cord from the two-line telephone into the L1+L2 jack of the triplex adapter. Or, you can plug the two-line telephone into the TEL jack of the two-line TAD.

Multi-Line Connections (PBX)

Most offices use a central telephone system. While it is often relatively simple to connect the MFC to a key system or a PBX (Private Branch Exchange), we suggest that you contact the company that installed your telephone system and ask them to connect the MFC for you. It is advisable to have a separate line for the MFC. You can then leave the MFC in FAX mode to receive faxes any time of day or night.

If the MFC is to be connected to a multi-line system, ask your installer to connect the unit to the last line on the system. This prevents the unit from being activated each time a telephone call is received.

- ⊘ As with all fax units, this MFC must be connected to a two wire system. If your line has more than two wires, proper connection of the MFC cannot be made.

If You are Installing the MFC to Work with a PBX:

- 1 It is not guaranteed that the unit will operate correctly under all circumstances with a PBX. Any cases of difficulty should be reported first to the company that handles your PBX.
- 2 If all incoming calls will be answered by a switchboard operator, it is recommended that the Receive mode be set to MANUAL. All incoming calls should initially be regarded as telephone calls.
- 3 The MFC may be used with either pulse or tone dialing telephone service.

Custom Features on Your Phone Line

If you have Voice Mail, Call Waiting, Call Waiting/Caller ID, RingMaster, an answering service, an alarm system, or other custom feature on one phone line, it may create a problem with the operation of your MFC. (See *I have difficulty with custom features on a single line*, page 21-7.)

3

On-Screen Programming

User-Friendly Programming

We have designed your Multi-Function Center with on-screen programming and a Reports key. User-friendly programming helps you take full advantage of all the menu selections your MFC has to offer.

Since your programming is done on the LCD, we created step-by-step on-screen prompts to help you program your MFC. All you need to do is follow the prompts as they guide you through the menu selections and programming options. Additionally, you can program settings more quickly by pressing **Menu** and the menu numbers using the dial pad.

Alternating Displays

Sometimes, the LCD alternates between the active setting and a help message giving brief instructions about how to proceed. The LCD you'll probably see most often is shown below. When you place an original in the ADF, it appears to tell you that you can dial a number and send a fax, or you can make a copy.

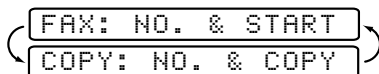

Menu Mode

You can access the Menu mode by pressing **Menu**. The LCD shows:

Then

Press **1** for General Setup—**OR**—

1. GENERAL SETUP

Press **2** for Fax Operations—**OR**—

2. FAX

Press **3** for Copy Operations—**OR**—

3. COPY

Press **4** for Print Operations—**OR**—

4. PRINTER

When you enter Menu mode, your MFC scrolls a list of Main menu options from which you can choose. These menu options appear one after the other on the LCD. Select a menu by pressing **Set** when that option appears on the LCD. The LCD will scroll the options within that next menu.

You can scroll more quickly through options by pressing **▶**. Use **◀** to scroll backward if you passed your choice or to see options in the opposite order. When the LCD shows your selection, press **Set**.



When you finish a setting, the LCD shows **ACCEPTED**.

If you want to exit the Menu mode, press **Stop/Exit**.

Menu Selection Table

You can probably perform most of these programming settings without the Owner's Manual. To help you understand the menu selections, options and settings that are found in the MFC programs, use the Menu Selection Table below.

Main Menu	Submenu	Menu Selections	Options	Descriptions	Page	
1. GENERAL SETUP	1. PAPER SIZE	—	LETTER LEGAL A4	Selects size of paper for received faxes.	4-1	
	2. DATE/TIME	—	—	Enter date and time for the LCD display and heading on fax transmissions.	4-2	
	3. STATION ID	—	—	Program your name, fax number and telephone number to appear on each transmitted page.	4-3	
	4. VOLUME	1. RING		OFF LOW MED HIGH	Adjusts ring volume.	4-5
		2. BEEPER		OFF LOW HIGH	Adjusts beeper volume.	4-5
		3. SPEAKER		OFF LOW MED HIGH	Adjusts speaker volume.	4-5



The factory setting (option) is shown in bold.

Main Menu	Submenu	Menu Selections	Options	Descriptions	Page
1. GENERAL SETUP (continued)	5. CASSETTE #2	—	ON OFF	Turn CASSETTE #2 ON if you purchased the optional Cassette #2.	4-1
	6. AUTO DAYLIGHT	—	ON OFF	Changes for Daylight Savings Time automatically.	4-5
	7. TONER SAVE	—	ON OFF	Increases life of toner cartridge.	4-6
	8. SLEEP MODE	—	—	Conserves power	4-6
	9. TONE/ PULSE (Canada Only)	—	PHONE PULSE	Selects dialing mode.	4-6
	0. LOCAL LANGUAGE (Canada Only)	—	ENGLISH FRENCH	Allows you to change the LCD Language to French.	See French Manual
2. FAX	1. SETUP RECEIVE	1. RING DELAY	00 01 02 03 04 05	Number of rings before the MFC answers in FAX, EXTERNAL TEL/ TAD or MANUAL mode.	5-2
		2. EASY RECEIVE	ON OFF	Receive fax messages without pressing the Fax Start key.	5-3
		3. REMOTE CODE	ON (* 51) OFF	Activate the MFC from a remote location. You can also personalize these codes.	5-4
		4. AUTO REDUCTION	ON OFF	Reduces size of image.	5-3
		5. PRINT DENSITY	- ■ ■ ■ □ □ +	Makes prints darker or lighter.	5-4
		6. POLLING RX	ON OFF	Sets up your MFC to poll another fax machine.	5-5
		7. PC FAX RECEIVE	ON OFF	Turn ON if PC is connected to MFC for PC receiving of messages.	5-6



The factory setting (option) is shown in bold.

Main Menu	Submenu	Menu Selections	Options	Descriptions	Page
2. FAX (continued)	2. SETUP SEND	1. CONTRAST	AUTO S.LIGHT S.DARK	Changes lightness or darkness of a fax you are sending.	6-6
		2. FAX RESOLUTION	STANDARD FINE S.FINE PHOTO	Changes the default setting of fax resolution.	6-7
		3. DELAYED TIMER	00:00	Sets the time of day that delayed faxes will be sent.	6-10
		4. DELAYED FAX	—	Sends documents later.	6-10
		5. BATCH TX	ON OFF	Sends all delayed faxes that are to the same fax number and at the same time as one transmission.	6-11
		6. REAL TIME TX	NEXT FAX ONLY ON OFF	You can send a fax without using memory.	6-5
		7. POLLED TX	ON OFF	Sets up your MFC with a document to be retrieved by another fax machine.	6-11
		8. COVERPG SETUP	NEXT FAX ONLY ON OFF PRINT SAMPLE	Automatically sends a cover page you program.	6-8, 6-9
		9. COVERPAGE MSG	—	Programs customized message for fax cover page.	6-8
		0. OVERSEAS MODE	ON OFF	Adjusts for sometimes difficult overseas transmissions.	6-10



The factory setting (option) is shown in bold.

Main Menu	Submenu	Menu Selections	Options	Descriptions	Page
2. FAX (continued)	3. SET AUTO DIAL	1. ONE-TOUCH DIAL	—	Store One-Touch numbers so you can dial by pressing only one key (and Fax Start).	7-1
		2. SPEED-DIAL	—	Store Speed Dial numbers so you can dial by pressing only four keys (and Fax Start).	7-2
		3. SETUP GROUPS	—	Sets up a Group number for broadcasting.	7-3
	4. SETUP REPORTS	1. TRANSMISSION	ON ON+IMAGE OFF OFF+IMAGE	Initial setup for Transmission Verification Report and Fax Activity Report.	10-1
		2. ACT. INTERVAL	6/12/24 Hours 2/4/7 Days OFF		10-1
	5. REMOTE FAX OPT	1. FAX FWD/ PAGING	OFF FAX FORWARD PAGING	Sets the MFC to forward fax messages— OR —to call your pager.	9-1
		2. FAX STORAGE	ON OFF	Stores incoming faxes in memory for remote retrieval.	9-2
		3. REMOTE ACCESS	159 *	Personalizes code for retrieving faxes.	9-3
		4. PRINT FAX	—	Prints backup copy of incoming faxes stored in the memory.	5-5



The factory setting (option) is shown in bold.

Main Menu	Submenu	Menu Selections	Options	Descriptions	Page
2. FAX (continued)	6. REMAINING JOBS	—	—	Check which jobs are in memory — OR —cancel a delayed fax or polling job.	5-6, 6-5, 6-6
	0. MISCELLANEOUS	1. DISTINCTIVE	ON OFF SET	Uses the telephone company Distinctive Ring subscriber service to register the ring pattern with the MFC.	8-3
		2. CALLER ID	DISPLAY # PRINT REPORT	View or print a list of the last 30 Caller IDs stored in memory.	8-4
		3. DRUM LIFE	—	You can check the percentage of drum life that remains available.	21-22
3. COPY	1. COPY MODE	—	AUTO TEXT PHOTO	Selects the Copy resolution for your type of original.	11-9
	2. CONTRAST	—	- ■ ■ ■ □ □ +	Adjusts the contrast.	11-9
	3. PAPER TYPE	—	THIN PLAIN THICK THICKER	Identify the type of paper in the multi-purpose sheet feeder.	11-9
4. PRINTER	1. PRINT OPTIONS	1. INTERNAL FONT	—	You can print resident fonts to check and confirm font types.	13-7
		2. CONFIGURATION	—	Printer settings and status are listed here.	13-7
	2. RESET PRINTER	1. FACTORY SET	—	You can restore the printer back to the factory default settings.	13-7



The factory setting (option) is shown in bold.



4 Initial Setup

Getting Started

Setting Paper Size

You can use three sizes of paper for printing your faxes: letter, legal and A4. When you change the size of paper you have loaded in the MFC, you will need to change the setting for the paper size, so your MFC will know how to fit the incoming fax on the page.

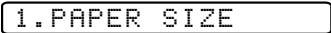
After you connect the optional Cassette #2, you can select the paper size for each cassette. (See *Turning on Cassette #2*)

- 1 Press **Menu, 1, 1.** 
- 2 If you have the Cassette #2, press ◀ or ▶ to select **CASSETTE #1** or **CASSETTE #2**, and then press **Set.** 
- 3 Press ◀ or ▶ to select **LETTER, LEGAL** or **A4** (for the cassette you selected in Step 2), and then press **Set.**
- 4 Press **Stop/Exit.**







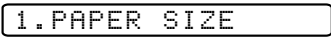

Turning on Cassette #2 (Option)

When the optional **CASSETTE #2** is set to **ON**, you can set paper size and the cassette usage. (See *Printing a Reduced Incoming Document (Auto Reduction)*, page 5-3 and *Setting Paper Size*, above.)

- 1 Press **Menu, 1, 5.** 
- 2 Use ◀ or ▶ to select **ON** (or **OFF**), and then press **Set.**
- 3 Press **Stop/Exit.**

Setting Cassette Usage



The default setting of **AUTO** allows your MFC to choose the optional Cassette #2 if paper is out in Cassette #1 or if incoming faxes will fit best on the paper in Cassette #2. Choose **CASSETTE#1 ONLY**, **CASSETTE#2 ONLY** or **CASSETTE USAGE** if you want to keep special paper in the other cassette and control when it is used.

- 1 Press **Menu, 1, 1.** 
- 2 Press  or  to select **CASSETTE USAGE**, and then press **Set**.
- 3 To set cassette usage for faxes, press  or  to select **FOR FAX**, and then press **Set**.
—**OR**—To set cassette usage for copies, press  or  to select **FOR COPY**, and then press **Set**.
—**OR**—If you are finished, go to Step 5.
- 4 Press  or  to select **AUTO**, **CASSETTE#1 ONLY** or **CASSETTE#2 ONLY**, and then press **Set**.
- 5 Press **Stop/Exit**.

Setting Date and Time

Your MFC displays the date and time, and prints it on every fax you send.

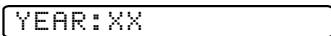
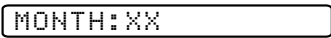
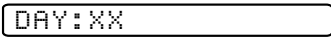
In the event of a power failure, you may have to reset the date and time. All other settings remain unaffected.

- 1 Press **Menu, 1, 2.** 
- 2 Enter the last two digits of the year, and then press **Set**.
For example, enter 02 for the year 2002. 
- 3 Enter two digits for the month, and then press **Set**.
For example, enter 09 for September, or 10 for October. 
- 4 Enter two digits for the day, and then press **Set**.
For example, 06 
- 5 Enter the time in 24-hour format, and then press **Set**.
For example, enter 15:25 for 3:25 PM. 
- 6 Press **Stop/Exit**.
The LCD now shows the date and time you set whenever the MFC is standing by.

Setting Station ID

You should store your name or (company name) and fax number to be printed on all fax pages you send. The telephone number you enter will be printed only on your cover pages and call back messages. (See *Composing Electronic Cover Page*, page 6-7.)

1 Press **Menu, 1, 3.**

3. STATION ID

2 Enter your fax number (up to 20 digits), and then press **Set.**

FAX:

(You must enter a fax number to proceed.)

3 Enter your telephone number (up to 20 digits), and then press **Set.** If your telephone number and fax number are the same, enter the same number again. (This number appears on Cover pages.)

TEL:

4 Use the dial pad to enter your name or your company name (up to 20 characters), and then press **Set.** (See *Entering Text*, page 4-4.)

NAME:

5 Press **Stop/Exit.**

The LCD returns to the date and time.



If your Station ID has already been programmed, the LCD prompts “1” to make a change, or “2” to exit without changing.

NOTICE

The Telephone Consumer Protection Act of 1991 makes it unlawful for any person to use a computer or electronic device to send any message via a telephone machine unless such messages clearly contain, in a margin at the top or bottom of each transmitted page, or on the first page of the transmission, the date and time it is sent and an identification of the business or other entity or other individual sending the message and the telephone number of the sending machines or such business, other entity, or individual.

In order to program this information into your MFC, you should complete the steps described on pages 4-2 and 4-3.

Entering Text

When you are setting certain menu selections, such as the Station ID, you may need to type text into the MFC. Most number keys have three or four letters printed above them. The keys for 0, #, and * don't have printed letters because they are used for special characters.

By pressing the appropriate number key repeatedly, you can access the character you want.

Key	once	twice	three times	four times
2	A	B	C	
3	D	E	F	
4	G	H	I	
5	J	K	L	
6	M	N	O	
7	P	Q	R	S
8	T	U	V	
9	W	X	Y	Z

Inserting Spaces

If you want to enter a blank space, press  twice.

Making Corrections

If you entered a letter incorrectly and want to change it, press  to move the cursor after the last correct letter. Then press **Stop/Exit**; all letters above and to the right of the cursor will be deleted. Re-enter the correct characters. You can also back up and type over incorrect letters.

Repeating Letters

If you need to enter a character that is assigned to the same key as the previous character, press  to move the cursor to the right.

Special Characters and Symbols

Press * for (space) ! " # \$ % & ' () * + , - . /

Press # for : ; < = > ? @ [] ^ _

Press 0 for É À È Ê Î Ç Ë Ö 0

Setting the Ring Volume

- 1 Press **Menu, 1, 4, 1.**
- 2 Press **<** or **>** to select **OFF, LOW, MED, or HIGH**, and then press **Set.**
- 3 Press **Stop/Exit.**

1. RING

Setting the Beeper Volume

You can set the beeper to **LOW, HIGH** or **OFF**. The default setting is **LOW**. When the beeper is set to **LOW** or **HIGH**, the MFC beeps every time you press a key or make an error and when fax sending or receiving has finished.

- 1 Press **Menu, 1, 4, 2.**
- 2 Press **<** or **>** to select your option.
- 3 When the LCD shows the option you want, press **Set.**
- 4 Press **Stop/Exit.**

2. BEEPER

Setting the Speaker Volume

You can set the volume of the MFC's one-way speaker.

- 1 Press **Menu, 1, 4, 3.**
- 2 Press **<** or **>** to select **OFF, LOW, MED, or HIGH**, and then press **Set.**
- 3 Press **Stop/Exit.**

3. SPEAKER

Memory Storage

In the event of a power failure, all menu settings are stored permanently: **GENERAL SETUP, SETUP RECEIVE, SET AUTO DIAL, REMOTE FAX OPT** plus the **COVERPG SETUP** and **COVERPAGE MSG** (from **SETUP SEND**). You may have to reset the date and time.

Turning On Automatic Daylight Savings Time



You can set the MFC to change automatically for Daylight Savings Time. It will reset itself forward one hour in the Spring and back one hour in the Fall.

- 1 Press **Menu, 1, 6.**
- 2 Press **<** or **>** to select **ON** (or **OFF**), and then press **Set.**
- 3 Press **Stop/Exit.**

6. AUTO DAYLIGHT

Toner Save

You can conserve toner using this feature. When you set Toner Save to **ON** print appears somewhat lighter. The default setting is **OFF**.

- 1 Press **Menu, 1, 7.**
- 2 Press  or  to select **ON** (or **OFF**) and then press **Set**.
- 3 Press **Stop/Exit**.

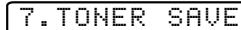

Sleep Mode

Setting the Sleep Mode reduces power consumption while the MFC is idle. You can choose how long the MFC is idle (from 00 to 99 minutes) before it drops into sleep mode. The timer automatically resets itself after the MFC receives a fax or PC data, or makes a copy. The default setting is 5 minutes.



- 1 Press **Menu, 1, 8.**
- 2 Use the Dial pad to enter the length of time the MFC is idle before it drops into sleep mode (00 to 99 minutes), and then press **Set**.
- 3 Press **Stop/Exit**.



If you make copies frequently, make the idle time long enough so you won't always be waiting for the MFC to warm up.

Setting Tone/Pulse Dialing Mode (For Canada Only)

Your MFC comes set to accommodate tone (multi-frequency) dialing service. If you have pulse (rotary) dialing service, you need to change the dialing mode.

- 1 Press **Menu, 1, 9.**
- 2 Press  or  to select **TONE** or **PULSE** dialing mode, and then press **Set**.
- 3 Press **Stop/Exit**.



5 Setup Receive

Receive Mode Settings

Select Your Receive Mode

There are three different receive modes for your MFC. You may choose the mode that best suits your needs by pressing **Receive Mode** repeatedly until the LCD shows the setting you want to use.

LCD	How it works	When to use it
FAX ONLY (automatic receive)	The MFC automatically answers every call as a fax.	For dedicated fax lines.
EXT.TEL/TAD (External telephone / External Telephone Answering Device)	<p>If an external telephone is connected to the EXT. jack, you control the phone line and must answer every call yourself.</p> <p>If an external TAD (telephone answering device) is connected to the EXT. jack, the TAD automatically answers every call. Voice messages are stored in the external TAD. Fax messages are printed.</p>	<p>Use this mode if you receive very few faxes.</p> <p>Use this mode if you have an external answering machine on your phone line.</p>
MANUAL (manual receive)	You control the phone line and must answer every call yourself by using an external phone.	Use this mode when you are using a computer modem on the same line or if you receive very few fax messages. You can use this mode with Distinctive Ring.

To Select or Change Your Receive Mode

- 1 Press **Receive Mode**. The LCD shows your current selection.

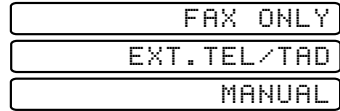

- 2 Continue to press **Receive Mode** until your new selection appears. After two seconds, the LCD returns to the date and time display, along with your new Receive Mode setting.



If you are changing the Receive Mode while in another operation, the LCD returns to that operation.



Current Receive Mode . . .

FAX: FAX ONLY
EXT: EXTERNAL TEL/TAD
MHL: MANUAL

Setting Ring Delay

The Ring Delay setting determines the number of times the MFC rings before it answers. If you have extension phones on the same line as the MFC or are using the telephone company's Distinctive Ring service, keep the Ring Delay default setting of **4**. You can try increasing the Ring Delay to 5 rings; however, if you do not receive all your faxes, you must reset it to 4 rings.

- 1 Press **Menu, 2, 1, 1**.
- 2 Press **◀** or **▶** to select how many times the line rings before the MFC answers (00–05), and then press **Set**. If you select 00, the line doesn't ring at all.
- 3 Press **Stop/Exit**.



Easy Receive

When you use this feature, you don't have to press **Fax Start** when you answer a fax call. Selecting **ON** allows the MFC to receive fax calls automatically, even if you lift the handset of an extension or external phone. When you see **RECEIVING** on the LCD or when you hear "chirps" through the handset of an extension phone, just replace the handset and let your MFC do the rest. Selecting **OFF** means you'll have to activate the MFC yourself, by lifting the handset of an external or extension phone, and then pressing **Fax Start** on the MFC or by pressing *** 5 1** if you are not at your MFC. (See *Operation from Extension Telephone*, page 5-4.)



If Easy Receive is **OFF** and an original is in the ADF, lift the handset of an external or extension phone, press **Fax Start** and **2** to activate the MFC.



If you've set the feature to **ON**, but your MFC doesn't automatically connect a fax call when you lift a handset, press the Fax Receive code *** 5 1** on the external or extension phone.



If you send faxes from a computer on the same phone line and the MFC intercepts them, set Easy Receive to **OFF**.

1 Press **Menu, 2, 1, 2**.

2.EASY RECEIVE

2 Use **<** or **>** to select **ON** (or **OFF**), and then press **Set**.

3 Press **Stop/Exit**.

Printing a Reduced Incoming Document (Auto Reduction)

Your MFC can reduce the size of an incoming fax to fit the size of the paper you loaded.

Select **ON** to turn on this feature.

After you connect Cassette #2, you can turn on Automatic Reduction for each cassette. (See *Turning on Cassette #2 (Option)*, page 4-1).

1 Press **Menu, 2, 1, 4**.

4.AUTO REDUCTION

2 If you have the optional Cassette #2 press



< or **>** to select **CASSETTE #1** or **CASSETTE #2**, and then press **Set**.

3 Use **<** or **>** to select **ON** (or **OFF**), and then press **Set**.

4 Press **Stop/Exit**.

Setting the Print Density

You can adjust print density, making your printed pages darker or lighter than the original.

- 1 Press **Menu, 2, 1, 5**.
- 2 Press  to make print lighter, or  to make print darker.
- 3 Press **Stop/Exit**.

5.PRINT DENSITY

Advanced Receiving Operations

Operation from Extension Telephone



If you answer a fax call on an extension phone (or on an external phone in the EXT. jack), you can make your MFC take over by using the Fax Receive Code. When you press the Fax Receive Code *** 5 1**, the MFC starts to receive a fax. (See *Easy Receive*, page 5-3.)

If you answer a call at an extension or external phone, and no one is on the line, assume you're receiving a fax. At an extension phone, press *** 5 1**, wait for fax receiving tones (chirps), then hang up. At an external phone, press *** 5 1** and wait for the phone to be disconnected (the LCD shows **RECEIVING**) before you hang up. (Your caller will have to press **Fax Start** to send the fax.)

Changing the Fax Receive Code

The preset Fax Receive Code (*** 5 1**) may not work with some telephone systems.

If you are always disconnected when accessing your external TAD remotely, try changing the Fax Receive Code from *** 5 1** to **###**.

- 1 Press **Menu, 2, 1, 3**.
- 2 Press  or  to select **ON** (or **OFF**), and then press **Set**.
- 3 If you want to, enter a new Fax Receive Code, and then press **Set**.
- 4 Press **Stop/Exit**.

3.REMOTE CODE

REMOTE ACT.:ON?

FAX RECEIVE:*51

Printing a Fax in Memory

If you have Fax Storage ON for remote retrieval, you can still print a fax from memory when you are at your MFC. (See *Setting Fax Storage*, page 9-2.)

- 1 Press **Menu**, **2**, **5**, **4**.
- 2 Press **Fax Start**.
- 3 After printing is finished, and then press **Stop/Exit**.



4. PRINT FAX

Polling

Polling is the process of retrieving faxes from another fax machine. You can use your MFC to “poll” other machines, or you can have someone poll your MFC.



All parties involved in polling must set up their fax machines to accommodate polling. When someone polls your MFC to receive a fax, they pay for the call; if you poll someone’s fax machine to receive a fax, you pay for the call.



Some fax machines do not respond to the polling feature.

Setting Up Polling Receive

Polling Receive is when you call another fax machine to receive a fax from it.





- 1 Press **Menu**, **2**, **1**, **6**.
- 2 Press  or  to choose **ON**, and then press **Set**.
- 3 Enter the fax number you’re polling.
- 4 Press **Fax Start**.
The LCD shows **DIALING**.



6. POLLING RX

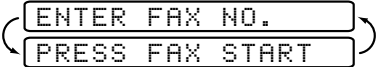

Setting Up Sequential Polling Receive

Your MFC can request documents from several fax units in a single operation. Afterward, a Sequential Polling Report will be printed.

- 1 Press **Menu, 2, 1, 6.** 
- 2 Press  or  to select **Polling ON** (or **OFF**), and then press **Set**.
- 3 Specify the destination fax machines you wish to poll using One Touch, Speed Dial, Groups or the dial pad. You must press **Set** between each location. 
- 4 Press **Fax Start**.
The LCD shows **DIALING**.
Your MFC will poll each number or Group member in turn for a document. 



Canceling a Scheduled Job

You can cancel tasks you've scheduled, such as Delayed Fax, Polling Receive, Polling Transmit or faxes in memory waiting to be sent. (See *Checking the Jobs Status*, page 6-5.)

- 1 Press **Menu, 2, 6.** 
Jobs waiting to be sent from memory appear on the display. If there are no jobs, the LCD shows **NO JOB WAITING**.
- 2 If you have more than two jobs waiting, press  or  to select the job you want to cancel, and then press **Set**.
- 3 Press **1** to cancel—**OR**—Press **2** to exit without canceling.
To cancel another job, return to Step 2.
- 4 Press **Stop/Exit**.

PC-FAX Receive Mode

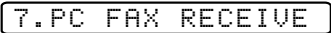
You can switch PC-FAX Receive Mode on and off as needed. If you want your fax messages to go directly into your PC, make sure the MFL Link Pro suite setting is **ON**. If you want faxes to print on your MFC when they arrive, you can switch MFL Link Pro suite mode to **OFF**. (See *On-Line Documentation on the Brother CD-ROM*.)

- 1 Press **Menu, 2, 1, 7.** 
- 2 Press  or  to select **ON** (or **OFF**), and then press **Set**.
- 3 Press **Stop/Exit**.

6 Setup Send

Before You Begin

You can send a fax from the ADF (Automatic Document Feeder) or from the scanner glass.

Sending Faxes Using Multiple Settings

When you send a fax you can choose any combination of the available settings: add a cover page and select a comment; set the contrast or resolution; send using overseas mode, or delayed fax timer, polling transmission or real time transmission. After each menu selection is accepted, the LCD will ask if you want to enter other settings:

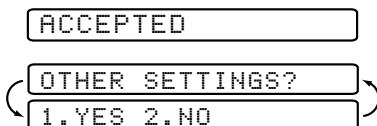

Press **1** if you want to select additional settings. The LCD returns to the SETUP SEND menu—**OR**—Press **2** if you are finished choosing settings, and go to the next step.

Faxing from the ADF (Automatic Document Feeder)

The ADF can hold up to 50 pages, feeding each one individually through the MFC. Use standard (20 lb/75g/m²) paper when using the ADF. Always fan the pages well before placing them in the ADF.

- ⊘ **DO NOT** use curled, wrinkled, folded, ripped paper, or paper with staples, paper clips, paste or tape attached. **DO NOT** use cardboard, newspaper, or fabric. (To fax this kind of original, see *Faxing from the Scanner Glass*, page 6-3.)
- Make sure originals written with ink are completely dry.
- Before you send a fax, press **Fax Resolution** to select the resolution for the type of original you are sending. (See *Fax Resolution*, page 6-7.)

- Originals to be faxed must be from 5.8 to 8.5 inches wide and between 5 to 14 inches long.

- 1 Insert originals *face up, top edge first*.
- 2 Adjust the paper guides to fit the width of your original.
- 3 Stagger the pages. Then place them in the ADF until you feel the first page lightly touch the feed roller.

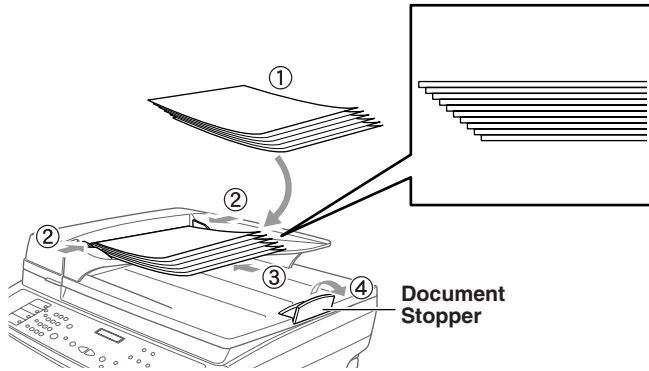
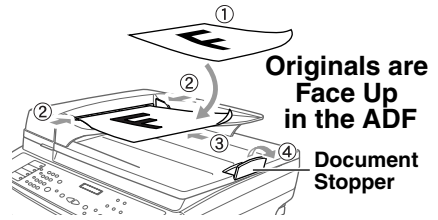

- 4 Pull up the document stopper.

Faxing from the Scanner Glass

You can use the scanner glass to fax one page at a time or pages of a book. Originals can be Letter or A4 size (8.5 inches to 11.7 inches).

! To use the scanner glass, the ADF must be empty.

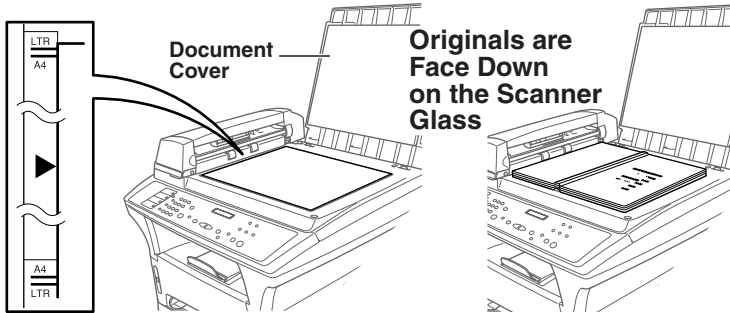

- 1 Lift the document cover.
- 2 Using the document guidelines on the left, center the original *face down* on the scanner glass.
- 3 Close the document cover.

! If the original is a book or is thick, do not slam down the cover or press on it.

- 4 Dial the fax number, then press **Fax Start**. The MFC starts scanning the first page.
- 5 To send a single page, go to Step 7
—OR—
To send multiple pages, go to Step 6.

MEMORY #001 99%

NEXT:PRESS SET

DIAL:PRESS START

- 6 Place the next page on the scanner glass, and then press **Set**. The MFC starts scanning. (Repeat Step 6 for each additional page.)
- 7 Press **Fax Start** to begin dialing.



Press **Stop/Exit** to cancel. If the original was scanned into memory, press **1** to **CLEAR** it—OR—**2** to **EXIT**.



If memory is full, and you are faxing a single page, it will be sent in real time.



You cannot fax from the scanner glass when the MFC is sending, receiving or printing a fax.

Manual Transmission

Manual transmission lets you hear the dial tone, ringing and fax receiving tones while sending a fax.

- 1 Place the original face up in the ADF, or face down on the scanner glass.
- 2 Pick up the handset of the external telephone and listen for a dial tone.
- 3 Dial the number you want to call (you can enter the digits using the dial pad, or you can enter a One Touch or Speed Dial number).
- 4 When you hear the fax tone, press **Fax Start**—**OR**—If you are using the scanner glass, go to Step 5.
- 5 Press **1**.

Automatic Transmission

This is the easiest way to send a fax.

- 1 Place the original face up in the ADF, or face down on the scanner glass.
- 2 Enter the fax number using One Touch, Speed Dial, Search or the dial pad. (See *Speed Dialing*, page 7-4.)
- 3 Press **Fax Start**.

Manual and Automatic Fax Redial

If you're sending a fax manually and the line is busy, press **Redial/Pause** to retry the number.

If you're sending a fax automatically and the line is busy, the MFC will automatically redial (up to three times at 5 minute intervals).

Dual Access

If the ADF is empty, you can place an original in the ADF and set temporary settings, dial a number, and begin scanning the fax into memory—even when the MFC is receiving a fax, sending a fax, or printing a fax from memory. The LCD shows the new job number and available memory.



You cannot fax from the scanner glass while the MFC is sending, receiving or printing a fax.

If you get an **OUT OF MEMORY** message while scanning the first page of a fax, press **Stop/Exit** to cancel the scan. If you get an **OUT OF MEMORY** message while scanning a subsequent page, you'll have the option to press **Fax Start** to transmit the pages scanned so far, or to press **Stop/Exit** to cancel the operation.









The number of pages you can scan into memory varies with the data they contain.

Real Time Transmission



When you are sending a fax, the MFC will scan originals into memory before sending. Then, as soon as the phone line is free, the MFC will start dialing and sending the fax. If memory becomes full, the MFC will send the document in real time (even if **REAL TIME TX** is set to **OFF**).

Sometimes you may want to send an important document immediately, without waiting for memory transmission. You can set **REAL TIME TX** to **ON**.

- 1 Place the original face up in the ADF, or face down on the scanner glass.
- 2 Press **Menu, 2, 2, 6**.

- 3 To change the default setting, press  or  to select **ON** (or **OFF**), and then press **Set**. Go to Step 5—**OR**—For the next fax transmission only, press  or  to select **NEXT FAX ONLY**, and then press **Set**.
- 4 For the next fax only, press  or  to select **ON** (or **OFF**), and then press **Set**.
- 5 Press **1** if you want to select additional settings. The LCD returns to the **SETUP SEND** menu—**OR**—Press **2** if you are finished choosing settings, and then go to Step 6.
- 6 Enter fax number.
- 7 Press **Fax Start**.

Checking the Jobs Status

Check memory for unsent jobs. (If no memory is clear, the LCD shows **NO JOB WAITING**.) (See *Canceling a Job in Memory*, page 6-6.)

- 1 If the MFC is idle, press **Menu, 2, 6**.
—**OR**—
If the MFC is busy, press **Stop/Exit**.

- 2 If you have multiple jobs waiting, use  or  to scroll through the list.
- 3 Press **Stop/Exit**.

Canceling a Job While Scanning the Original



You can cancel a job while you are scanning it into memory by pressing **Stop/Exit**. Eject the document by pressing **Stop/Exit** again.

Canceling a Job in Memory

You can cancel tasks you've scheduled, such as Delayed Fax, Polling Receive, Polling Transmit or faxes in memory waiting to be sent. If jobs are waiting, they will appear on the LCD; otherwise, the LCD will show **NO JOB WAITING**.

- 1 Press **Menu, 2, 6**.

6. REMAINING JOBS

- 2 If you have more than two jobs waiting, use  or  to select the job you want to cancel, and then press **Set**.

—OR—

If you have only one job waiting, go to Step 3.

- 3 Press **1** to cancel—OR—Press **2** to exit without canceling. To cancel another job, return to Step 2.
- 4 Press **Stop/Exit**.



Basic Sending Operations

Contrast

If your document is very light or very dark, you might want to set the contrast. Use **S.LIGHT** to send a very light document. Use **S.DARK**, to send a very dark document.

- 1 Place the original face up in the ADF, or face down on the scanner glass.

1. CONTRAST

- 2 Press **Menu, 2, 2, 1**.
- 3 Use  or  to select **AUTO, S.LIGHT** or **S.DARK**, and then press **Set**.
- 4 Press **1** if you want to select additional settings. The LCD returns to the **SETUP SEND** menu—OR—Press **2** if you are finished choosing settings, and go to Step 5.
- 5 Enter a fax number, and then press **Fax Start** to send a fax.

Fax Resolution

When you have an original in the ADF or on the scanner glass, you can use the **Fax Resolution** key to temporarily change the setting. Press **Fax Resolution** repeatedly until the LCD shows the setting you want.

—OR—

You can change the default setting for all faxes.

1 Press **Menu, 2, 2, 2**.

2.FAX RESOLUTION

2 Press **◀** or **▶** to select the resolution you want, and then press **Set**.

3 Press **Stop/Exit**.

STANDARD - Suitable for most typed documents.

FINE - Good for small print; transmits a little slower than Standard resolution.

SUPER FINE - Good for small print or artwork; transmits slower than Fine resolution.

PHOTO - Use when original has varying shades of gray; slowest transmission time.

Composing Electronic Cover Page

The cover page is generated at the receiving party's MFC. Your cover page includes the name stored in the One Touch or Speed Dial memory. If you are dialing manually, the name is left blank. (See *One Touch Dialing* and *Speed Dialing*, page 7-4.)

The cover page indicates your Station ID and the number of pages you're sending. If you have Coverpage Setup set to ON (**Menu, 2, 2, 8**), the number of pages remains blank. (See *Setting Station ID*, page 4-3.)

You can include a comment on your cover page.

1.COMMENT OFF

2.PLEASE CALL

3.URGENT

4.CONFIDENTIAL

Instead of using one of the pre-programmed comments above, you can enter one of two customized messages. (Up to 27 characters long) Use the chart on page 4-2 to help enter characters. (See *Composing Your Own Comments*, page 6-8.)



5.(USER DEFINED)

6.(USER DEFINED)

Most of the **SETUP SEND** menu selections are temporary settings that allow you to make adjustments for each fax you send. However, you can set up your cover page and cover page comments in advance. The Cover Page Setup and Cover Page Message menu selections change the default settings.

Composing Your Own Comments







You can set up two custom comments.

- 1 Press **Menu, 2, 2, 9.** 
- 2 Press  or  to choose position 5 or 6 for your customized comment, and then press **Set.**
- 3 Use the dial pad to enter your customized comment, and then press **Set.** (See *Entering Text*, page 4-4.)
- 4 Press **1** if you want to select additional settings. The LCD returns to the **SETUP SEND** menu—**OR**—Press **2** if you are finished choosing settings.

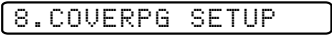
Cover Page for the Next Fax Only

Make sure the Station ID is set up. (see page 4-3.) This feature does not work without the Station ID.

You can set the fax to send a cover page with a particular fax. This cover page will include the number of pages in your original.

- 1 Place the original face up in the ADF, or face down on the scanner glass.
- 2 Press **Menu, 2, 2, 8.** 
- 3 When the LCD shows **NEXT FAX ONLY**, press **Set.**
- 4 Press  or  to select **ON** (or **OFF**), and then press **Set.**
- 5 Press  or  to select one of the standard or custom comments, and then press **Set.**
- 6 Enter two digits to indicate the number of pages you are sending, and then press **Set.** (For example, press **0 2** for **2**.) (Enter **0 0** to leave the number of pages blank.) If you make a mistake, press  to back up and reenter the number of pages.
- 7 Press **1** if you want to select additional settings. The LCD returns to the **SETUP SEND** menu—**OR**—Press **2** if you are finished choosing settings.
- 8 Enter the fax number you're calling.
- 9 Press **Fax Start.**

Always Send Cover Page

Make sure the Station ID is set up. This feature does not work without the Station ID. (See *Setting Station ID*, page 4-3.)

You can set the MFC to send a cover page whenever you send a fax. The number of fax pages is not included when you use this setting.

- 1 Press **Menu, 2, 2, 8.** 
- 2 Press **<** or **>** to select **COVERPAGE: ON**, and then press **Set**.
- 3 If you selected **ON**, press **<** or **>** to select one of the standard or custom comments, and then press **Set**.
- 4 Press **1** if you want to select additional settings. The LCD returns to the **SETUP SEND** menu—**OR**—Press **2** if you are finished choosing settings.

Using a Printed Cover Page

If you prefer using a printed cover page that you can write on, you can print the sample page and attach it to your fax.



- 1 Press **Menu, 2, 2, 8.** 
- 2 Press **<** or **>** to select **PRINT SAMPLE**, and then press **Set**.
- 3 Press **Fax Start**. Your MFC prints a copy of your cover page.

```
==== COVER PAGE ====  
  
TO: _____  
  
FROM: _____  
FAX: _____  
TEL: _____  
  
PAGE(S) TO FOLLOW  
  
COMMENT:
```

Advanced Sending Operations

Overseas Mode



After you send a fax using this feature, the feature turns itself off.

- 1 Place the original face up in the ADF, or face down on the scanner glass.
- 2 Press **Menu, 2, 2, 0**.

- 3 Press  or  to select **ON** (or **OFF**), and then press **Set**.
- 4 Press **1** if you want to select additional settings. The LCD returns to the **SETUP SEND** menu—**OR**—Press **2** if you are finished choosing settings.
- 5 Enter the fax number you're calling.
- 6 Press **Fax Start**.

Delayed Timer

You can set up the time of day that delayed faxes will be sent. This time will be displayed for acceptance or you can override it in *Delayed Fax*.

(See *Advanced Sending Operations*, page above.)

- 1 Press **Menu, 2, 2, 3**.

- 2 Enter the time (in 24-hour format) that you want delayed faxes to be sent, and then press **Set**.

- 3 Press **Stop/Exit**.

Delayed Fax

During the day you can store up to 50 faxes in memory for delayed sending. Transmission of these messages will begin at the time of day you enter in Step 3. If you have set up a time of day in *Delayed Timer* on page 6-10, you can accept it or enter another time for this fax.

- 1 Place the original face up in the ADF, or face down on the scanner glass.
- 2 Press **Menu, 2, 2, 4**.

- 3 Accept the displayed time or enter another time for this fax, and then press **Set**.
(For example, enter 19:45 for 7:45 PM.)
- 4 Press **1** if you want to select additional settings. The LCD returns to the **SETUP SEND** menu—**OR**—Press **2** if you are finished choosing settings.
- 5 Enter the fax number.
- 6 Press **Fax Start**.

The MFC starts scanning the original into memory. It will wait until the time you have entered to send the fax.



The number of pages you can scan into memory varies with the data they contain.

Delayed Batch Transmission

Before sending the delayed faxes, your Brother MFC will economize by sorting all the messages in memory by destination and scheduled time. All delayed faxes scheduled at the same time to the same fax number will be sent as one transmission.

- 1 Press **Menu, 2, 2, 5**.
- 2 Press or to select **ON** (or **OFF**), and then press **Set**.
- 3 Press **Stop/Exit** to exit.

5. BATCH TX

Setting Up for Polling Transmit

Polling Transmit is when you set up your MFC to wait with an original in the ADF so another fax machine can retrieve it.

- 1 Place the original face up in the ADF, or face down on the scanner glass.
- 2 Press **Menu, 2, 2, 7**.
- 3 Press or to choose **ON** (or **OFF**), and then press **Set**.
- 4 Press **1** if you want to select additional settings. The LCD returns to the **SETUP SEND** menu—**OR**—Press **2** if you are finished choosing settings.
- 5 Press **Fax Start** and wait for the fax to be polled.

7. POLLED TX





If you pressed **1** in Step 4, the original remains in the ADF until your MFC is polled. If you must use your MFC before the polled transmit occurs, you must cancel this job.

7 Auto Dial Numbers and Dialing Options

Storing Numbers for Easy Dialing

You can set up your MFC to do three types of easy dialing: One Touch, Speed Dial, and Groups for Broadcasting of faxes. You can store names with these numbers for easy identification.

-  If you must wait for another dial tone at any point in the dialing sequence, store a pause at that point in the number by pressing **Redial/Pause**. Each key press adds a 3.5 second delay.
-  If you lose electrical power, auto dial numbers stored in memory will *not* be lost.

Storing One Touch Dial Numbers

You can store 8 fax/phone numbers that you can dial by pressing one key (and **Fax Start**). To access numbers 5 to 8, hold down the **Shift** key. When you press a One Touch dial location, the LCD shows the name or number as the call is dialed. (See *One Touch Dialing*, page 7-4.)

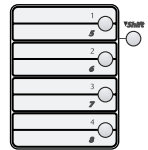

One Touch keys are the 4 keys (numbers 01–08) located on the left side of the control panel.

-  (For USA only) One-Touch key **1** has been pre-programmed for the Brother fax-back system.

1 Press **Menu**, **2**, **3**, **1**.

1. ONE-TOUCH DIAL

2 Press the One Touch key where you want to store a number.

3 Enter a number (up to 20 digits), and then press **Set**.
(See *Changing One Touch and Speed Dial Numbers*, page 7-2.)

-  If you want to enter a pause in the dialing sequence (for example, to access an outside line), press **Redial/Pause** as you're entering digits. Each key press of **Redial/Pause** enters a 3.5 second pause when the number is dialed, and a dash appears on the screen.

4 Use the dial pad to enter the name (up to 15 characters), and then press **Set**
—OR—Press **Set** to store the number without a name. (See *Entering Text*, page 4-4.)

NAME:

5 Return to Step 2 to store another number—OR—Press **Stop/Exit**.
When you dial an auto dial number, the LCD shows the name you've stored, or, if you haven't stored a name, the number you've stored.

Storing Speed Dial Numbers

You can store Speed Dial numbers, so you can dial by pressing only four keys (**Search/Speed Dial**, **#**, the two digit location, and **Fax Start**). The MFC has 100 Speed Dial locations. (See *Speed Dialing*, page 7-4.)

1 Press **Menu**, **2**, **3**, **2**.

2. SPEED-DIAL

2 Use the dial pad to enter a two-digit location (00–99), and then press **Set**.

SPEED-DIAL? #

3 Enter the number (up to 20 digits), and then press **Set**.

#05:

4 Use the dial pad to enter the name (up to 15 characters), and then press **Set**.

NAME:

You can use the chart on page 4-2 to help you enter letters—**OR**—Press **Set** to store the number without a name.

5 Return to Step 2 to store another Speed Dial number—**OR**—Press **Stop/Exit**.



Changing One Touch and Speed Dial Numbers

If you try to store a One Touch or Speed Dial number in a location where a number is already stored, the LCD shows the current name stored there, then prompts you to either

1. CHANGE 2. EXIT

1 Press **1** to change the number, or press **2** to exit without changing it.

2 Enter a new number, and then press **Set**.

- If you want to erase the number, press **Stop/Exit** when the cursor is to the left of the digits.
- If you want to change a digit, use  or  to position the cursor under the digit you want to change, then type over it.

3 Follow the directions from Step 4 for *Storing One Touch Numbers* or *Storing Speed Dial Numbers*.

Setting Up Groups for Broadcasting

Groups allow you to send the same fax message to many fax numbers by pressing only one One Touch Group key (and **Fax Start**). **First**, you'll need to store each fax number as a One Touch or Speed Dial number. **Then**, you can combine them into a Group. *Each Group uses up a One Touch key or a Speed Dial location.* Finally, you can have up to six small Groups, or you can assign up to 107 numbers to one large Group. (See *Broadcasting*, page 7-5.)

1 Press **Menu, 2, 3, 3.**

3.SETUP GROUPS

2 Select a One Touch key where you wish to store the Group number.

For example, press One Touch key **02** for Group 1.

PRESS SPEED DIAL

OR ONE-TOUCH KEY

3 Use the dial pad to enter the Group number, and then press **Set.**

For example, press **1** for Group 1.

SETUP GROUP:GO

4 To include One Touch or Speed Dial numbers in the Group, enter them as if you were dialing. For example, for One Touch key **05**, and then press One Touch key **05**. For Speed Dial location 09, press **Search/Speed Dial**, and then press **0, 9** on the dial pad. The LCD shows * 05, #09.

G01:*05#09

5 When you're finished adding numbers, press **Set.**

6 Use the dial pad and the chart on page 4-4 to enter a name for the Group, and then press **Set.**

For example, **NEW CLIENTS.**

NAME:

7 Press **Stop/Exit.**



You can print a list of all One Touch and Speed Dial numbers. (See *Chapter 10, Printing Reports.*)

Dialing Options





When you dial an auto dial number, the LCD shows the name you've stored, or if you haven't stored a name, the fax number you've stored.

Search

You can search for names you have stored in One Touch and Speed Dial memories. Names are stored alphabetically. (See *Storing One Touch Dial Numbers*, page 7-1 and *Storing Speed Dial Numbers*, page 7-2.)

1 Place the original face up in the ADF, or face down on the scanner glass.

2 Press **Search/Speed Dial**, and then enter the first letter of the name you're looking for.

3 Press  or  to search the name that are stored alphabetically.

4 When the LCD shows the name you want to call, press **Fax Start** to begin dialing.

If you use the scanner glass, press **Fax Start** again.

Speed Dialing

- 1 Place the original face up in the ADF, or face down on the scanner glass.
- 2 Press **Search/Speed Dial**, **#**, and then press the two-digit Speed Dial number.
- 3 Press **Fax Start**.

One Touch Dialing

- 1 Place the original face up in the ADF, or face down on the scanner glass.
- 2 Press the One Touch key of the location you want to call.
- 3 Press **Fax Start**.



If you try to use a One Touch or Speed Dial location with no number stored in it, you hear a warning sound, and LCD shows **NOT REGISTERED**. The LCD returns to normal after 2 seconds.

Access Codes and Credit Card Numbers

Sometimes you may want to choose from among several long distance carriers when you make a call. Rates may vary depending upon the time and destination. To take advantage of low rates, you can store the access codes or long-distance carriers as One Touch and Speed Dial numbers. You can store these long dialing sequences by dividing them and setting them up separately in any combination. You can even include manual dialing using the dial pad. The combined number will be dialed in the order you entered it, as soon as you press **Fax Start**. (See *Storing One Touch Dial Numbers*, page 7-1.)

You store “555” on One Touch key **03** and “7000” on One Touch key **02**. If you press One Touch **03**, **02** and **Fax Start** you will dial “555-7000”. To temporarily change a number, you can substitute part of the number with manual dialing using the dial pad. For example, to change the number to 555-7001 you can press One Touch **03**, and then press **7, 0, 0, 1** using the dial pad.



If you must wait for another dial tone at any point in the dialing sequence, store a pause at that point in the number by pressing **Redial/Pause**. Each key press adds a 3.5 second delay.

Broadcasting

Broadcasting is automatically sending the same fax message to multiple fax numbers. Using the **Set** key, you can include Groups, One Touch locations, Speed Dial locations and up to 50 manually dialed numbers. The easiest way to Broadcast is to press Group keys. If you did not use up any locations for Groups, access codes or credit card numbers, you can “broadcast” faxes automatically to up to 158 different locations from the MFC. However, available memory will vary with all types of jobs in memory and numbers of locations used for broadcasting. If you broadcast to more than the maximum locations available, you will not be able to set up transmissions using dual access and the timer. (See *Setting Up Groups for Broadcasting*, page 7-2.)

You must press **Set** between each of these locations.

Use the **Search/Speed Dial** to help you choose the numbers easily.

After the broadcast is finished, a Broadcast Report will be printed automatically to let you know the results.

- To stop the broadcasting in progress, press **Stop/Exit**. The LCD asks if you want to cancel all locations or only the location that is being sent.
 - Enter the long dialing sequence numbers as you normally would. Keep in mind that each key counts as one location, so the number of locations you can call becomes limited.
 - If the line is busy or for other reasons a connection could not be made while broadcasting, the MFC will redial the number automatically.
 - If the memory is full, press **Stop/Exit** to abort the job; or, if more than one page has been scanned, press **Fax Start** to send the portion that is in the memory.
- 1 Place the original face up in the ADF, or face down on the scanner glass.
 - 2 Enter a number using One Touch, Speed Dial, Group number, Search or the dial pad.
Example: Group number
 - 3 Press **Set**. You will be prompted to press the next number.
 - 4 Enter the next number.
Example: Speed Dial number
 - 5 Press **Set**.
 - 6 Enter the fax number.
Example: Manual dialing using the dial pad.
 - 7 Press **Fax Start**.
Your MFC will read the original into memory and then start sending faxes to the numbers you entered.

Pause

Press **Redial/Pause** to insert a 3.5 second pause between numbers. If you are dialing overseas, you can press **Redial/Pause** as many times as needed to increase the length of the pause.

Fax Redial

If you're sending a fax manually and the line is busy, press **Redial/Pause** to try again. Anytime you want to make a second call to the last number dialed, press **Redial/Pause** to save time.

Tone/Pulse (For Canada Only)

If you have pulse dialing service, but need to send tone signals (for example, telephone banking), follow the directions below. If you have touch tone service, you do not need this feature to send tone signals.

- 1** Lift the handset of an external phone.
- 2** Press **#**. Digits dialed after **#** will send tone signals.
- 3** When you hang up, the MFC returns to pulse dialing service.

Custom Feature

Your MFC supports the Distinctive Ring and Caller ID telephone services offered by some telephone companies.



If you have Voice Mail, Call Waiting, Call Waiting/Caller ID, RingMaster, an answering service, or on alarm system custom feature on your telephone line, it may create a problem in the operation of your MFC.

If you have Voice Mail on you phone line, please read the following carefully.

Distinctive Ring

The term “Distinctive Ring” is used by Brother to identify a phone company service that is given *many names, depending on the telephone company you are using*. For example, this service may be called SmartRing, RingMaster, Teen-Ring, Indent-a-Call or Indent-a-Ring.

What Does Your Telephone Company’s “Distinctive Ring” Do?

Your telephone company’s Distinctive Ring service allows more than one number to be on the same phone line. **If you need more than one phone number, it is an inexpensive alternative to paying for an additional line.** Each phone number has its own distinctive ring pattern, so you will know which phone number is ringing. This is one way you can have a separate phone number for your MFC.



Please consult your telephone company for availability and rates.

What Does Brother’s “Distinctive Ring” Do?

The Brother MFC has a Distinctive Ring feature that allows you to use your MFC to take full advantage of the telephone company’s Distinctive Ring service. You can dedicate the new phone number on your line to receiving only faxes.



You must purchase your telephone company’s Distinctive Ring service *before* you program the Brother MFC to work with it.

Do You Have Voice Mail?

If you have Voice Mail on the phone line you on which will install your new MFC on, *there is a strong possibility that Voice Mail and the MFC will conflict with each other while receiving incoming calls.* **However, this Distinctive Ring feature allows the use of more than one number on your line, so both Voice Mail and the MFC can coexist peacefully.** If each one has a separate phone number, neither will interfere with the other's work.





If you decide to get the Distinctive Ring Service from the telephone company, you will need to follow the directions below to "register" the new Distinctive Ring pattern they provided, so your MFC can recognize its incoming calls.



You can change or cancel the Distinctive Ring pattern at any time. You can switch it off temporarily, and later turn it back on. When you get a new fax number, make sure you reset this setting.

Before You Choose the Ring Pattern to Register

You can register only one Distinctive Ring pattern with the MFC. Some ring patterns cannot be registered. Please refer to some popular ring pattern examples that will be provided from the phone company in the USA and Canada that are shown in the Brother compatibility table below.

Ring Pattern	Rings	
1	long - long	
2	short - long - short	
3	short - short - long	
4	very long (normal pattern)	







If the ring pattern the phone company provided cannot be registered by the fax, **please check for other available ring pattern choices from the phone company.**

- The MFC will answer only calls to its registered number.
- The first two rings are silent on the MFC. This is because the fax must «listen» to the ring pattern (compare it to the pattern that was "registered").
- If you program the MFC correctly, it will recognize the registered ring pattern of the "fax number" within 2 ring patterns and then automatically answer with a fax tone. When the "voice number" is called, the MFC will not interrupt the call.

Very Important

If you have Voice Mail, or a TAD (Telephone Answering Device) and want to keep one of your phone numbers dedicated only to fax calls, you must leave the MFC in **MANUAL** mode at all times while using the Distinctive Ring Feature. Here's why: Manual mode will never pick up a call by itself, since it is «Neutral». When the MFC is in this «neutral» mode, the Distinctive Ring Feature can be activated. The Distinctive Ring Feature is actually an answering mode. So, do not activate **FAX ONLY** mode while using distinctive ring; otherwise, the MFC will answer calls for *all* the numbers.

Registering the Distinctive Ring Pattern

- 1 Set the MFC to **MANUAL** mode. 
- 2 Press **Menu, 2, 0, 1**.
- 3 Press  or  to select **DISTINCTIVE:SET** and then press **Set**.
- 4 Press  or  to select the prestored ring pattern you want to assign, and then press **Set**. (You will hear each pattern as you scoll through the four patterns.) Be sure to choose the pattern assigned by the Telephone Company.
- 5 Press **Stop/Exit**.

Caller ID

The Caller ID feature of this MFC lets you use the Caller ID subscriber service offered by many local phone companies. This service provides the LCD, the name or telephone number of your caller on the LCD as the line rings. (See *Printing Caller ID List*, page 8-4.)







After a few rings, the LCD shows the telephone number of your caller (or name, if available). Once you pick up the handset, the Caller ID information disappears from the LCD, but the call information remains stored in the Caller ID memory.

- You will see the first 16 characters of the number or name.
 - **OUT OF AREA** means call originates outside your Caller ID service area.
 - **PRIVATE CALL** means the caller has intentionally blocked transmission of information.
-  If both the name and number are received, the LCD shows only the name. You can print a list of Caller ID information received by your MFC.

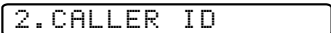
Caller ID service varies with different carriers. Call your local telephone company to determine the kind of service available in your area.

Viewing Caller ID List

Caller ID memory stores information for up to thirty calls; when the thirty-first call comes in, information about the first call is erased. You can scroll through Caller ID information to review those calls made to your MFC.

- 1 Press **Menu, 2, 0, 2.** 
- 2 Press  or  to select **DISPLAY #** and then press **Set**.
If the name was not received, it will not be displayed.
- 3 Press  or  to scroll through the Caller ID memory to select the Caller ID you want to view and then press **Set**.
The next LCD shows the caller's telephone number and the date and time of the call.
- 4 Press  or  to return to the Caller ID listing—**OR**—Press **Stop/Exit**.

Clearing a Caller ID Stored in Memory

For effective use of the memory, we recommend that you clear the Caller IDs stored in memory by pressing **Stop/Exit** when the LCD shows each caller ID number or name.

Printing Caller ID List

- 1 Press **Menu, 2, 0, 2.** 
- 2 Press  or  to select **PRINT REPORT**, and then press **Set**.
- 3 Press **Fax Start** to exit.

9

Remote Fax Options

Fax Forwarding/Paging



*You cannot use Paging and Fax Forwarding at the same time.
To use Paging or Fax Forwarding you must set Fax Storage to ON.*

Programming a Fax Forwarding Number

When Fax Forwarding is set to ON, your MFC stores the received fax in memory. Then it dials the fax number you've programmed and forwards the fax message.

- 1 Press **Menu, 2, 5, 1.**

1.FAX FWD/PAGING

- 2 Press or until the LCD shows **FAX FORWARD**, and then press **Set**.

- 3 The LCD prompts you to enter the number of the fax machine where faxes will be forwarded. Enter the forwarding number (up to 20 digits), and then press **Set**.

- 4 Press **Stop/Exit**.

Programming Your Pager Number

When Paging is selected, your MFC dials the pager number you've programmed, and dials your Personal Identification Number (PIN); this activates your pager so you know you have a fax message in the memory.

- 1 Press **Menu, 2, 5, 1.**

1.FAX FWD/PAGING

- 2 Press or until the LCD shows **PAGING**, and then press **Set**.

- 3 Enter your pager phone number (up to 20 digits) followed by **# #**, and then press **Set**. Do not include the area code if it is the same as that of your MFC.

PAG#:

For example,

1 8 0 0 5 5 5 1 2 3 4 # #.

- 4 If your pager requires a PIN, enter the PIN, and then press **#**, press **Redial/Pause**, enter your fax number followed by **# #**, and then press **Set**.
For example, **1 2 3 4 5 # Redial/Pause 1 8 0 0 5 2 1 2 8 4 6 # #**.
—OR—

If you do not need a PIN, press **Redial/Pause**, enter your fax number followed by **# #**, and then press **Set**.

For example,

Redial/Pause 1 8 0 0 5 2 1 2 8 4 6 # #.

- 5 Press **Stop/Exit**.



You cannot change a Paging number or PIN remotely.

Press **Redial/Pause** for each 3.5 second delay, as needed.

Setting Fax Storage

If you set Fax Storage to **ON**, you will be able to retrieve fax messages from another location using Fax Forwarding, Paging or Remote Retrieval operations. The LCD will indicate when you have a fax stored in memory. The LCD prompts you to choose a fax setting.

- 1 Press **Menu, 2, 5, 2**.

2.FAX STORAGE

- 2 Press **◀** or **▶** to select **ON** (or **OFF**), and then press **Set**.

- 3 Press **Stop/Exit**.



If there are faxes in memory when you turn Fax Storage **OFF**, you must choose to delete them or exit without turning Fax Storage on.

- 4 Press **1** to erase faxes from memory and to turn off Fax Storage.

ERASE ALL FAX?

1.YES 2.NO

—OR—

Press **2** to exit without deleting faxes or changing this setting.

(See *Printing a Fax in Memory*, page 5-5.)

Backup Print

If you have set **FAX STORAGE** to **ON**, your MFC *automatically* prints faxes as they are received into memory. This is a safety feature in case the power goes out so you won't lose your message.

Changing Remote Retrieval Access Code

Enter your Remote Retrieval Access Code when the MFC picks up your call, so you can access features remotely. The access code is preset to 1 5 9 ✱, however, you can change your access code. (See *Operation from Extension Telephone*, page 5-4.)

1 Press **Menu, 2, 5, 3**.

3.REMOTE ACCESS

2 Enter a three-digit number from 000 to 999, and then press **Set**.

The “✱” cannot be changed. Do not use the same digits that appear in your Fax Receive Code or Telephone Answer Code.

3 Press **Stop/Exit**.

Remote Retrieval

You can call your MFC from any fax machine using touch tone, then use the Remote Retrieval Access Code and other button presses to retrieve fax messages. *Cut out the Remote Retrieval Access Card on the last page and keep it in your wallet as an aid.*

Using Remote Retrieval Access Code

1 Dial your MFC phone number from a fax machine using touch tone.

2 When your MFC answers, immediately enter your Remote Retrieval Access Code (1 5 9 ✱).

3 The MFC signals the kinds of messages received:

1 long beep — Fax message(s)

No beeps — No messages

4 The MFC then prompts you with two short beeps to enter a command. If you wait longer than 30 seconds to enter a command, the MFC hangs up. If you enter an invalid command, the MFC beeps three times.

5 Press **9 0** to reset the MFC when you're finished.

6 Hang up.



If your MFC is set to **MANUAL** mode, you can access it by waiting about 2 minutes, and then entering the Remote Retrieval Access Code within 30 seconds.

Remote Commands

Follow the commands below to access features remotely. When you call the MFC and enter your Remote Retrieval Access Code (1 5 9 ✖), the system will signal you with two short beeps to enter a remote command.

Remote Commands	Operation Details
95 Changing Fax Forwarding/Paging setting 1 OFF 2 Fax Forwarding 3 Paging 4 FAX FWD No. 6 Fax Storage ON 7 Fax Storage OFF	 If you hear one long beep, the change is accepted. If you hear three short beeps, you cannot change it because the conditions have not been met. (Example: registering paging number.) You can register your fax forwarding number by using 4. FAX FWD NO. (See page 9-5.) Once you have registered the number, your MFC will change automatically to FAX FWD:ON mode. You can turn FAX STORAGE to ON or OFF.
96 Retrieve a fax 2 Retrieve all faxes 3 Erase fax from the memory	 Enter the number of a remote fax machine to receive stored fax message(s). (See page 9-5.) If you hear one long beep, you can erase fax message(s) from the memory.
97 Check the Receiving Status 1 Fax	 You can check whether your MFC has received any fax message(s). If yes, you will hear one long beep. If no, you will hear three short beeps.
98 Change Receive Mode 1 EXT. TEL/TAD 2 FAX	 If you hear one long beep, you can change the Receive Mode. If you hear three short beeps, you cannot change it.
90 Exit	After a long beep, you can exit remote control.

Retrieving Fax Messages

- 1 Dial your fax number.
 - 2 When your MFC answers, immediately enter your Remote Retrieval Access Code (**1 5 9 ***).
 - 3 As soon as you hear two short beeps, use the dial pad to press **9 6 2**.
 - 4 Using the dial pad, enter the number (up to 20 digits) of the remote fax machine where you want your fax messages forwarded, followed by **# #**.
-  You cannot use ***** and **#** as dial numbers. However, if you want to store a pause, press **#**.
- 5 After you hear your MFC beep, hang up and wait. Your MFC calls the remote fax machine. The remote fax machine prints your fax messages.

Changing Fax Forwarding Number

You can change the default setting of your fax forwarding number from a remote fax machine.

- 1 Dial your fax number.
 - 2 When your MFC answers, immediately enter your Remote Retrieval Access Code (**1 5 9 ***).
 - 3 When you hear two short beeps, use the dial pad to press **9 5 4**.
 - 4 Enter the new number (up to 20 digits) of the remote fax machine where you want your fax messages forwarded, followed by **# #**.
-  You cannot use ***** and **#** as dial numbers. However, if you want to store a pause, press **#**.
- 5 After you hear your MFC beep, hang up.

10 Printing Reports

MFC Settings and Activity

Two reports require initial setup in the Menu: Transmission Verification Report and Fax Activity Report Interval. For initial setup:

Press **Menu, 2, 4, 1**.

1. TRANSMISSION

—OR—

Press **Menu, 2, 4, 2**.

2. ACT. INTERVAL

Customizing the Transmission Verification Report

You can use the Transmission Report as proof that you sent a fax. This report lists the job number, time and date of transmission and whether the transmission was successful (OK). If you select **ON** or **ON+IMAGE**, the report will print for every fax you send.



When the feature is **OFF**, the report prints only if a transmission *error* prevented delivery (NG).

If you typically send multiple faxes to the same destinations, you may need more than the job numbers to know the faxes you must send again. Selecting **OFF+IMAGE** will print a portion of the fax's first page on the report to help you remember.

1 Press **Menu, 2, 4, 1**.

1. TRANSMISSION

2 Press **◀** or **▶** to select **OFF**, **OFF+IMAGE**, **ON** or **ON+IMAGE**, and then press **Set**.

3 Press **Stop/Exit**.

Setting the Fax Activity Report Interval

You can set the MFC to print activity reports at specific interval (6, 12, 24 hours, 2, 4, or 7 days). If you set the interval to **OFF**, you can print the report by following the Steps on the next page.

1 Press **Menu, 2, 4, 2**.

2. ACT. INTERVAL

2 Press **◀** or **▶** to choose an interval, and then press **Set**.

INTERVAL: OFF

(If you choose 7 days, the LCD prompts you to choose a day on which to begin the 7-day countdown.)

- 3 Enter the time to begin printing, in 24-hour format, and then press **Set**.
(For example: enter 19:45 for 7:45 PM.)
- 4 Press **Stop/Exit**.

Using the Reports Key



- 1 Press **Reports**.
- 2 Press **<** or **>** to select the report you want, and then press **Set**.

—OR—

Enter the number of the report you want to print. For example, press **1** to print the Help List.

Five reports are available:

1.HELP LIST	Prints the Help List so you can see at a glance how to quickly program every menu selection.
2.AUTO DIAL	Lists names and numbers stored in One Touch and Speed Dial memory, in numerical order.
3.FAX ACTIVITY	Lists information about the last 200 incoming and outgoing faxes. TX means Transmit; RX means Receive.
4.TRANSMISSION	Prints a transmission Verification Report for your last transmission.
5.USER SETTINGS	Lists settings for GENERAL SETUP , SETUP RECEIVE , SETUP SEND , SETUP REPORTS , REMOTE FAX OPT and MISCELLANEOUS .

 Don't forget to set up the Fax Activity Report and Transmission Verification Report as explained on page 10-1.

11 Making Copies

Basic Copy Operations

You can use your MFC as a copier, making up to 99 copies at a time. The MFC can stack the copies or collate (sort) them.

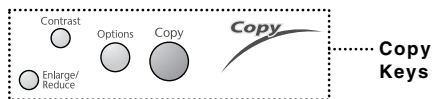

The scannable area of your MFC begins at approximately one-sixth inch (4mm) from the edge of the paper.

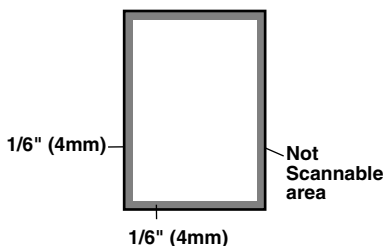

 Incoming faxes cannot be received on paper or into memory while the MFC is copying.

Making a Single Copy (Using the ADF)

1 Place the original face up in the ADF.

2 Press **Copy**.

Do **NOT** pull on the paper while copying is in progress.

A rectangular LCD display showing the text "COPYING" on the left and "P.01" on the right.

 To stop copying and eject the original, press **Stop/Exit**.
To release the original document, press **Stop/Exit**.

Making Multiple Copies (Using the ADF)

1 Insert the original *face up* in the ADF.

2 Use the dial pad to enter the number of copies you want (up to 99).

3 Press **Copy**.

 To sort the copies, use the **Options** key.
(See *Using the Options Key*, page 11-5.)

Single or Multiple Copies (Using the Scanner Glass)

If you want to sort multiple copies, use the ADF. (See *Sorting Multiple Copies (Using the ADF)*, page 11-5.)

- 1 Lift the Document Cover.

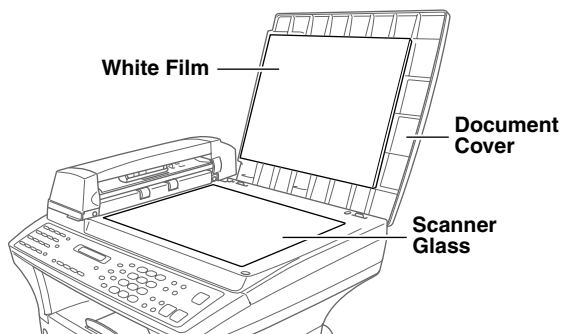

- 2 Using the document guide on the left, center the original *face down* on the scanner glass and close the Document cover.
- 3 Using the dial pad, enter the number of copies you want (up to 99).
- 4 Press **Copy** .

Out of Memory Message

If the memory becomes full while you are making copies, the LCD shows a message:

OUT OF MEMORY

If the **OUT OF MEMORY** message appears while you are scanning the first page of your original, press **Stop/Exit** to cancel. You will need to clear some faxes from memory before you can continue.



To gain extra memory, you can turn off Fax Storage (see page 9-2).
—OR—Print fax messages in memory (see page 5-5).

Temporary Copy Settings

You can improve your copies by using the Copy keys: **Enlarge/Reduce, Contrast** and **Options**. These settings are

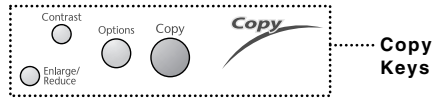

temporary, and the MFC returns to its default settings 30 seconds after it finishes copying. If you want to use these temporary settings again, place the next original in the ADF or on the scanner glass before the 30 seconds expire.

Copying Using Multiple Settings

You can try different combinations of settings for the best results. After you finish your settings using the **Enlarge/Reduce** or **Options** keys, the LCD shows:

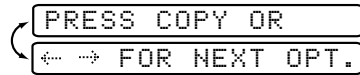

- Press or if you want to select additional settings.

—OR—

Press **Copy** if you are finished choosing settings.

Using Enlarge/Reduce Key

AUTO sets the MFC to calculate the ratio that fits the size of your paper.

ZOOM allows you to enter a ratio from 25% to 400% in 1% increments.

Press Enlarge/Reduce and or	25%
	50%
	78% LGL>LTR
	94% A4>LTR
	AUTO
	100%
	104% EXE>LTR
	150%
	200%
	400%
	ZOOM

- 1 Place the original face up in the ADF, or face down on the scanner glass.
- 2 Use the dial pad to enter the number of copies you want (up to 99).
- 3 Press **Enlarge/Reduce**. (Enlargement or reduction ratios appear.)
- 4 Press ◀ or ▶ to select **25%**, **50%**, **78%**, **94%**, **AUTO**, **100%**, **104%**, **150%**, **200%**, **400%**, or **ZOOM**, and then press **Set**. (Enlargement or reduction ratios appear.)

—OR—

For more choices select **ZOOM**, and then press **Set**. Use the dial pad to enter any percentage between **25%** and **400%**.

- 5 Press **Copy**—OR—Press ◀ or ▶ for additional settings.



Special Copy Options (2 in 1, 4 in 1, Poster or OFF) are not available with **Enlarge/Reduce**.



Poster copies require using the scanner glass.

When selecting an enlargement or reduction ratio, you will need to know the size of the paper you registered in Menu 1-1.

Selecting a Fixed Ratio:

Original is the size of...	Paper size is...	Recommended ratio is...
LETTER	LEGAL	100%
A4	LETTER	94%
LEGAL	LETTER	78%

Copy Contrast

You can adjust copy contrast to make copies darker or lighter.

- 1 Place the original face up in the ADF, or face down on the scanner glass.
- 2 Use the dial pad to enter the number of copies you want (up to 99).
- 3 Press **Contrast**. 
- 4 Press ◀ to make a copy lighter, or ▶ to make a copy darker, and then press **Set**.
- 5 Press **Copy**—OR—Press ◀ or ▶ for additional settings.

Using the Options Key

Use the **Options** key to temporarily change the copy mode (resolution), contrast and special copy options. See the explanations below the table.

Press Options	Menu Selections	Options	Factory Setting
 Options	OPT:# OF COPIES	NO. OF COPIES:XX	01
	OPT:COPY MODE	AUTO/TEXT/PHOTO	AUTO
	OPT:STACK/SORT	STACK/SORT	STACK
	OPT:SPECIAL	2 IN 1/4 IN 1/POSTER/OFF	OFF
	OPT:PAPER TYPE	THIN/PLAIN/THICK/ THICKER/TRANSPARENCY	PLAIN

Copy Mode (Type of Original)

You can select the Copy Mode for your type of original. The default setting is **AUTO**, which is used for originals that contain both text and photographs. **TEXT** is used for originals containing only text. **PHOTO** is used for copying photographs.

- 1 Place the original face up in the ADF, or face down on the scanner glass.
- 2 Use the dial pad to enter the number of copies you want (up to 99).
- 3 Press **Options** and ◀ or ▶ to select **OPT:COPY MODE**, and then press **Set**.
- 4 Press ◀ or ▶ to choose the type of original (**AUTO**, **TEXT** or **PHOTO**), and then press **Set**.
- 5 Press **Copy—OR—**Press ◀ or ▶ for additional settings.

Sorting Multiple Copies (Using the ADF)

- 1 Place the original face up in the ADF.
- 2 Use the dial pad to enter the number of copies you want (up to 99).
- 3 Press **Options** and ◀ or ▶ to select **OPT:STACK/SORT**, and then press **Set**.
- 4 Press ◀ or ▶ to select **SORT**, and then press **Set**.
- 5 Press **Copy—OR—**Press ◀ or ▶ for additional settings.

Special Copy Options (Using the ADF)

You can save paper by copying either two or four pages onto one page.

- 1 Place the originals, face up in the ADF.
- 2 Use the dial pad to enter the number of copies you want (up to 99).
- 3 Press **Options** and ◀ or ▶ to select **OPT:SPECIAL**, and then press **Set**.
- 4 Press ◀ or ▶ to select **2 IN 1**, **4 IN 1** or **OFF**, and then press **Set**.
- 5 Press **Copy**.

Special Copy Options (Using the Scanner Glass)

You can save paper by copying either two or four pages onto one page, or you can create poster size copy.

- 1 Place the original face down on the scanner glass.
- 2 Use the dial pad to enter the number of copies you want.
- 3 Press **Options** and ◀ or ▶ to select **OPT:SPECIAL**, and then press **Set**.
- 4 Press ◀ or ▶ to select **2 IN 1**, **4 IN 1**, **POSTER** or **OFF**, and then press **Set**.
- 5 Press **Copy**.



If you selected **2 IN 1** or **4 IN 1** in step 4, place the next original on the scanner glass, and then press **Set**. After all originals have been scanned, press **Copy**.

PRESS COPY OR

← → FOR NXT COPY

2 in 1



4 in 1

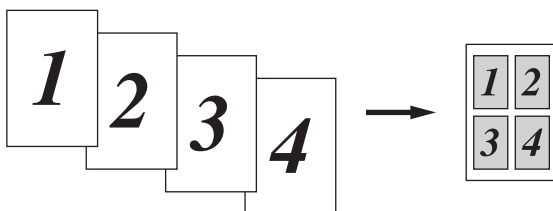

Special Copy Options (2 in 1, 4 in 1 or Poster) are not available with **Enlarge/Reduce**.





Incoming faxes cannot be received on paper or into memory while the MFC is making 2 IN 1 or 4 IN 1 copies.

Poster

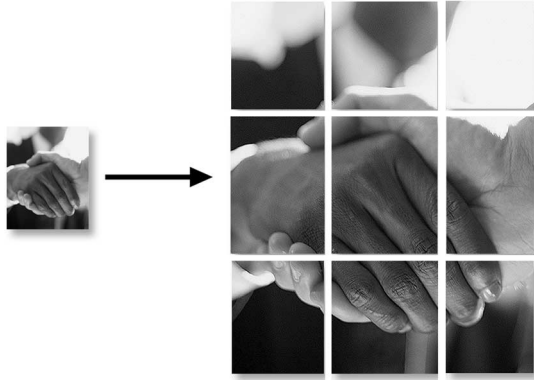
You can create a poster size copy of a photograph.



-  Special Copy Options (2in1, 4in1 or Poster) are not available with **Enlarge/Reduce**.
-  Poster is not available for multiple copies.
-  Poster copies require using the scanner glass.

Paper Type

You can use the following types of paper for copying. For the best print quality, select the type of media that you are using.

- THIN** (16lb - 18.4lb) - For thin paper or transparency
- PLAIN** (18.7lb - 25.3lb) - For ordinary plain paper
- THICK** (25.6lb - 32lb) - For heavy weight paper or rough paper
- THICKER** (32.3lb - 43lb) - For heavier weight paper, rough paper or bond paper.
- TRANSPARENCY** - For transparency (OHP)

- 1 Press **Options** and ◀ or ▶ to select **OPT:PAPER TYPE**, and then press **Set**.
- 2 Press ◀ or ▶ to select your type of paper, and then press **Set**.
- 3 Press **Copy**—OR—Press ◀ or ▶ for additional settings.

Changing Default Copy Settings

Press **Menu, 3** to change default settings for Copy mode. These settings will remain until you change them again by pressing **Menu**. Adjust the Copy Mode and Contrast settings.

By pressing a number, you can adjust copy settings as shown in the following chart. Press ◀ or ▶ to scroll through the options for each setting. Press **Set** to save your selection. Press **Stop/Exit**. —OR— Press ▶ to select the next setting you want to change.

Press **Menu**, and **3**.

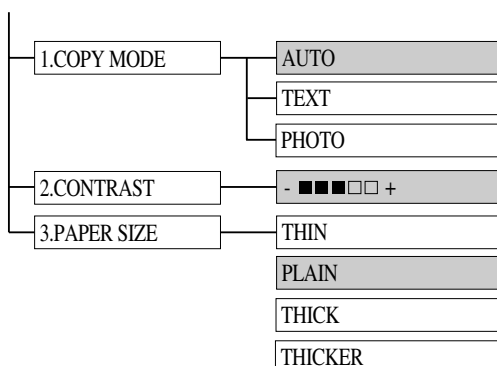

 is default

Copy Mode (Type of Original)

You can select the Copy Mode for your type of original. The default setting is **AUTO**, which is used for originals that contain both text and photographs. **TEXT** is used for originals containing only text. **PHOTO** is used for copying photographs.

1 Press **Menu, 3, 1.**

1. COPY MODE

2 Press \leftarrow or \rightarrow to choose the type of original (**AUTO**, **TEXT** or **PHOTO**), and then press **Set**.

3 Press **Stop/Exit**.

Copy Contrast

You can adjust copy contrast to make copies darker or lighter.

1 Press **Menu, 3, 2.**

2. CONTRAST

2 Press \leftarrow to make a copy lighter—**OR**—
Press \rightarrow to make a copy darker, and then press **Set**.

3 Press **Stop/Exit**.

Paper Type

You can use the following types of paper for copying. For the best print quality, select the type of media that you are most often.

THIN (16lb - 18.4lb) - For thin paper

PLAIN (18.7lb - 25.3lb) - For ordinary plain paper

THICK (25.6lb - 32lb) - For heavy weight paper or rough paper

THICKER (32.3lb - 43lb) - For heavier weight paper, rough paper or bond paper.

1 Press **Menu, 3, 3.**

3. PAPER TYPE

2 Press \leftarrow or \rightarrow to select your type of paper, and then press **Set**.

3 Press **Stop/Exit**.

After you connect the optional Cassette #2, you can select the paper size for each cassette. (See page 4-1.)

12 For DOS Users

How to Use the Brother MFC with Your DOS Application Software

Before working with your application software that runs on DOS, check that the Brother MFC's name appears in the printer selection of your application software. If the MFC is not listed, you must install the printer driver that corresponds to HP LaserJet IIP's emulations.

The following table shows combinations of printer drivers and emulation mode. To get the most out of this MFC, you should install an HP printer driver in your application software.

Printer driver supported in your application software	Emulation mode to be selected with the remote printer console program
HP LaserJet IIP™	HP LaserJet IIP emulation mode
HP LaserJet II™	Auto emulation selection

- The best or recommended printer driver is indicated in bold.
- Be sure to choose the proper printer driver in your application software.
- Be sure the printing resolution is set to 300 dpi in your DOS application software.

What Does the Remote Printer Console Do?

The Remote Printer Console (RPC) is a utility program that can run in the DOS environment and comprises the following program:

Remote Printer Console Main Program

This program allows you to change various printer settings such as emulation, print quality, fonts and page setup from your computer screen. Since most DOS applications have a Printer Settings menu that overrides the settings made by the RPC, you may not have to use this utility program. This utility program is useful for application software that does not control the printer's settings and features.

Installing the Remote Printer Console

Before you install the program, make sure you have the following hardware and software to install the program:

DOS	Version 3.3 or later
Monitor	EGA/VGA or compatible
Option	Mouse; the mouse driver must be installed. (You can also operate the program with the keyboard.)

Follow these steps to install the remote printer console program:

- 1** Make sure your Brother MFC is connected to your computer and is set to Online.
- 2** Start your computer and go to the DOS prompt. If you are in Windows®, exit and return to the DOS prompt.
- 3** Insert the Brother CD-ROM into your CD-ROM drive.
- 4** At the DOS prompt (C:\>) type *x*: (Substitute the drive letter of your CD-ROM drive for “*x*”), and then press Enter.

```
C:\>x:
```

- 5** Type CD RPCX, and then press Enter.

```
x:\>CD RPCX
```

- 6** Type RPCSETUP, and then press Enter.

```
x:\RPCX>RPCSETUP
```

- 7** Follow the instructions in the installer.

Using the Remote Printer Console Main Program

Type **C:\RPCX>RPCX**, and then press the Enter key to start the Remote Printer Console main program.

The Main Screen will appear on your computer screen as shown below.

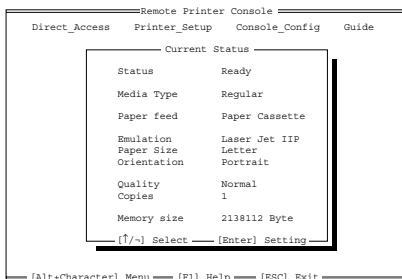

If bi-directional communication is enabled between your computer and MFC when it starts, the RPC gets the current settings information from your MFC. Otherwise, RPC shows its default settings. If you want to change settings, move the cursor to the item you want and select it using the **Enter** and **Cursor** keys. Then, press the **Enter** key to make the selected settings valid.

There are four sub menus. (See table below.) Select the sub menu you want by clicking on it with the mouse, using the cursor keys and the **Enter** key, or by pressing the hot key commands for that sub menu.

Menu	Press the keys	Functions
Direct Access	Alt + D	You can directly control the Brother MFC, with Print Form.
Printer Setup	Alt + P	You can enter the setting mode to change other printer settings, such as, margin settings, continue mode, font and sleep mode.
Console Config	Alt + C	You can change the environment settings for the RPC program: color, etc.
Guide	Alt + G	You can go to the Guide mode.
Help	F1	You can get Online Help: If you press F1, you can get information on a highlighted item.

Remote Printer Console

Current Printer Status Information

Item	Default	What This Item Does
Media Type	Regular	Selects the media type "Regular," "Thin Paper," "Thick Paper," "Thicker Paper," "Bond Paper" or "Transparency."
Paper Feed	Paper Cassette	Selects the paper feed mode, either "Paper Cassette" or "Manual."
Emulation*1	Laser Jet IIP	Selects "Laser Jet IIP."
Paper Size*1	Letter	Selects the paper size, either "Letter," "Legal," "A4," "Executive," "Monarch," "COM10," "DL," "C5," "B5," "A5," "A6," or "JIS B5."
Orientation*1	Portrait	Selects the paper direction, either "Portrait" or "Landscape."
Quality*1	Normal	Selects the print quality, either "Normal" or "Economy."
Copies*1	1	Sets the number of print copies from 1 to 999 pages.

*1 The items can be set in the current printer status information dialog box.

Printer Setup Category

Print Setup Section

Item	Default	What This Item Does
Copies	1	Sets the number of print copies from 1 to 999 pages.
Quality	Normal	Selects the print quality to either "Normal" and "Economy."
Emulation	Laser Jet IIP	Selects "Laser Jet IIP"

Page Setup Section

Item	Default	What This Item Does
Left Margin	*2	Sets the Left Margin value (0-145) columns.
Right Margin	*2	Sets the Right Margin value (10-155) columns.
Top Margin	0.5"	Sets the Top Margin 0", 0.33", 0.5", 1", 1.5" or 2".
Bottom Margin	0.5"	Sets the Bottom Margin 0", 0.33", 0.5", 1", 1.5" or 2".
Line / Page	*2	Sets the lines/pages (5-128).
Xoffset	0	Sets the Xoffset (vertical) value from 0 to 500 dots.
Yoffset	0	Sets the Yoffset (horizontal) value from 0 to 500 dots.

*1 These values (except Yoffset and Xoffset) are overridden by settings within your application software.

*2 These values depend on the paper size settings.

Font Configuration

Item	Default	What This Item Does
Font Source	Internal	“Internal”
Font name	Brougham10	Selects a font from any of the printer’s internal fonts (Brougham 10, 12 and Letter Gothic 16.66).
Pitch	10	Selects the font size of the selected font. If you selected the Brougham or LetterGothic font, Pitch is shown in the selection box.
Symbol Set	PC8	Selects the symbol set.

Other Configuration

Item	Default	What This Item Does
Auto LF	Off	Selects Auto LF “On or Off”
Auto CR	Off	Selects Auto CR “On or Off”
Auto Wrap	Off	Selects Auto Wrap “On or Off”
Auto Skip	On	Selects Auto Skip “On or Off”

Console Configuration Category

File	Function
Environment	Sets the Buzzer on/off, Color for Remote Print Console

For more information on RPC, see the Help Information in the program.

13 Using the Brother MFC as a Printer

Special Printing Features

Windows® Printing

The dedicated printer driver and TrueType™ compatible fonts for Microsoft® Windows® 95/98/98SE and NT4.0/2000 Professional are available on the CD-ROM supplied with your MFC. You can install them easily into your Windows® system using our installer program. The driver supports our unique compression mode to enhance printing speed in Windows® applications, and allows you to set various printer settings, including economy printing mode and custom paper size.

Popular Printer Emulation Support

The MFC supports HP LaserJet IIP printer emulation mode. If you use DOS application software, you can use HP LaserJet IIP emulation mode for printer operations. (Use the Remote Printer Console program to set the printer emulation.)

Remote Printer Console Program for DOS

The MFL Pro Suite CD-ROM supplied with your MFC includes the utility program Remote Printer Console (RPC). When you operate your computer in the Disk Operating System (DOS) environment, RPC lets you easily change the Brother MFC's default settings (such as fonts, page setup, emulations, etc.).

RPC also provides a status monitor Terminate-and-Stay Resident (TSR) program. It runs in the background and monitors the printer status as it reports the current status or errors on your PC screen.

Bi-directional Parallel Interface

The Brother MFC's parallel interface enables it to send memory and printer setup information to the computer.

Enhanced Memory Management

The Brother MFC has its own Data Compression Technology, which automatically compresses graphic data and downloads font data efficiently into the MFC's memory. With the MFC's standard memory, you can avoid memory errors and print most full-page, 600 dpi graphic and text data, including larger fonts.

Printing From Your PC

Multi-purpose Paper Cassette

The MFC's multi-purpose paper cassette can be adjusted to feed many sizes of paper: letter, legal, A4, B5 and A5 plain paper. When the MFC receives print data from your computer, it loads paper from the paper cassette. Insert the sheet of paper with the side you wish to print on face down in the paper cassette.

- Select the print command from your PC.

Your PC sends a print command and data to the MFC. The MFC displays the date and time and **RECEIVING DATA**. If there are more pages, the MFC begins to print the next page automatically. When printing is finished, it returns to online status.



You may select the proper paper source, paper size, and page orientation in your application software.

If your application software does not support your custom paper size, select the next larger paper size. Then adjust the print area by changing the right and left margins in your application software. (See *Acceptable Paper*, page 2-5.)



Use the manual feed slot for envelopes, labels, transparencies, card stock or thicker paper.

Two-Sided Printing (Manual Duplexing)

The supplied printer drivers for Windows® 95/98/Me and Windows NT® Workstation Version 4.0 enable manual duplex printing. (For more information, see the Help screen for the printer driver.)

The MFC prints all the even-numbered pages on one side of the paper first.

Then, the Windows® driver instructs you (with a pop-up message) to reinsert the paper. Before reinserting the paper, straighten it well, or you may get a paper jam. Very thin or very thick paper is not recommended.

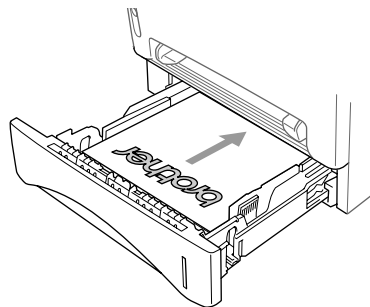

Caution

When you use manual duplexing, it is possible that a paper jam may occur or the print quality might not be satisfactory. (See *Paper is Jammed in the Paper Cassette*, page 21-4.)

Front Output Bin

The MFC ejects paper with printed surfaces *face down* into the output bin in the front of the MFC. Unfold the output bin extension to support the printed pages.



To prevent the possibility of transparencies smudging as they stack in the output bin, remove each transparency after it exits.

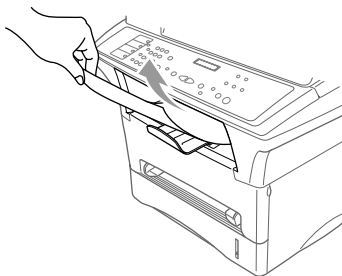

Manual Feed Slot

Your MFC has a manual feed slot above the paper cassette. You can load envelopes and special print media *one at a time* into this slot. You do not have to remove paper from the paper cassette.

(For information about *Acceptable Paper*, see page 2-5.) Insert the sheet of paper with the side you wish to print on face up in the manual feed slot.

Use the manual feed slot to print or copy on envelopes, labels, card stock or thicker paper.

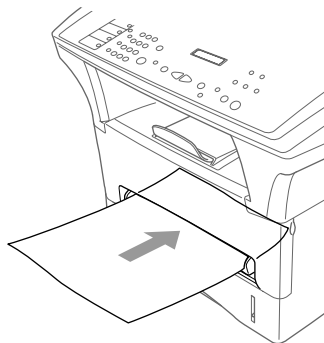

Loading One Sheet of Paper

You do not have to choose Manual Feed in the Setup dialog box of your printer driver. Insert the sheet of paper for Portrait (vertical) or Landscape (horizontal), with the side you wish to print on face up in the manual feed slot.

- 1 Align the paper at the center of the manual feed slot and insert it all the way.
- 2 Adjust the paper guides to the width of the paper.

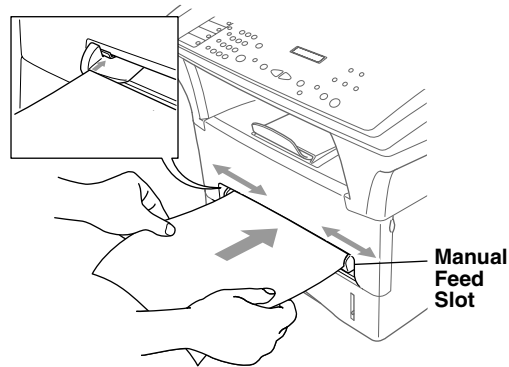

Loading More than One Sheet of Paper

- 1 Open the Setup dialog box of the Windows® printer driver and select Manual Feed in the Paper Source section. Follow Steps 1 and 2 above to load the first page. The MFC starts printing automatically.
- 2 After the first page is printed, the LCD displays:
Insert the next sheet of paper to resume printing.
- 3 Repeat Steps 1 and 2 until you have finished printing.



- To stop or clear the manual feed, turn the MFC offline by pressing the **Reset** key,—**OR**—Stop it with a PC command.



If you do not select Manual Feed, and insert a page in the manual feed slot, the MFC will load the first page from the manual feed slot and subsequent pages from the paper cassette.

Printing on Thicker Paper and Card Stock

When the rear cover is lifted up, the MFC has a straight paper path from the manual feed slot to the rear of the printer. Use this paper feed and output method when you want to print on envelope, thicker paper or card stock.

- 1 Select manual feed mode in the printer driver.
- 2 Send the print data as usual.
- 3 Lift up the rear cover at the rear of the MFC.

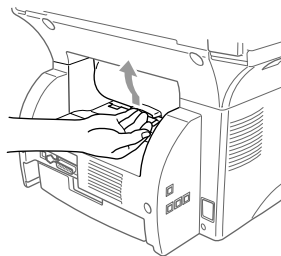

- 4 Adjust the manual feed paper guides to the width of the paper you are using.
- 5 Insert a single sheet of paper into the manual feed slot until the front edge touches the paper feed rollers. Let go of the paper as the MFC pulls it into position.
- 6 After the MFC ejects the printed page, return to Step 5 to insert the next sheet of paper. The MFC will wait until you insert the next sheet of paper. Repeat Steps 5 and 6 for each page to be printed.
- 7 When you have finished printing, close the rear cover of the MFC.



To prevent the possibility of transparencies smudging as they stack in the output bin, remove each transparency after it exits.

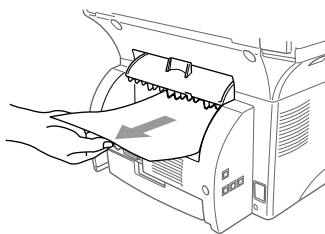

Simultaneous Printing/Faxing

Your MFC can print data from your computer while sending or receiving a fax, or while scanning information into the computer. However, when the MFC is copying or receiving a fax on paper, it pauses the PC printing operation, and resumes when copying or fax receiving is complete. Fax sending and receiving continues during PC printing/copying. (See *Acceptable Paper*, page 2-5.)

Choosing Acceptable Paper

We recommend that you test paper (especially special sizes and types of paper) on the MFC before purchasing large quantities.

- Avoid feeding labels with carrier sheets exposed, or your MFC will be damaged.
- Avoid using coated paper, such as vinyl coated paper.
- Avoid using preprinted or highly textured paper.

For optimum printing, use a recommend type of paper, especially plain paper and transparencies. For more information on paper specifications, consult your nearest authorized sales representative or the place where you purchased your MFC.

- Use label or transparencies that are designed for use in *laser* printers.
- For the best print quality, we recommend using long-grained paper.
- If you are using special paper, and the paper has problems feeding from the paper cassette, try again using the manual feed slot.
- You can use recycled paper in this MFC.

Printer Operation Keys

Reset Key

You can clear data from the memory.



Printing the Internal Font List

You can print a list of the MFC's internal (or resident) fonts to see how each font looks before you select it.

- 1 Press **Menu, 4, 1, 1**.
- 2 Press **Fax Start**. The MFC prints the list.
- 3 Press **Stop/Exit**.

1. INTERNAL FONT

Printing the Print Configuration List

You can print a list of current printer settings.

- 1 Press **Menu, 4, 1, 2**.
- 2 Press **Fax Start**. The MFC prints the settings.
- 3 Press **Stop/Exit**.

2. CONFIGURATION

Restoring Factory Default Settings

You can return the MFC to original factory settings. Permanent fonts are restored, macros in the temporary settings are cleared. You can change user settings using the Remote Printer Console program. (See page 12-1.)

- 1 Press **Menu, 4, 2, 1**.
- 2 Press **1** to restore the factory settings
—OR—Press **2** to exit without making a change.
- 3 Press **Stop/Exit**.

1. FACTORY SET

1. RESET 2. EXIT

14 Printer Driver Settings (For Windows® Only)

Using the Brother MFC-9700 Printer Driver

A Printer Driver is software that translates data from the format used by a computer into the format required by a particular printer, using a printer command language or page description language.

The printer drivers are on the supplied CD-ROM. The latest printer driver can also be downloaded from the Brother Solutions Center at

<http://solutions.brother.com>

Features in the Printer Driver (For Windows® 95/98/Me and Windows® NT 4.0 Users)



The screens shown in this section are from Windows® 98. The screens on your PC may vary depending on your Windows® Operating System.

For more detailed information, please see the on-line Help in the printer driver.

You can also change settings by clicking the illustration on the left side of the tab screen.

Basic Tab

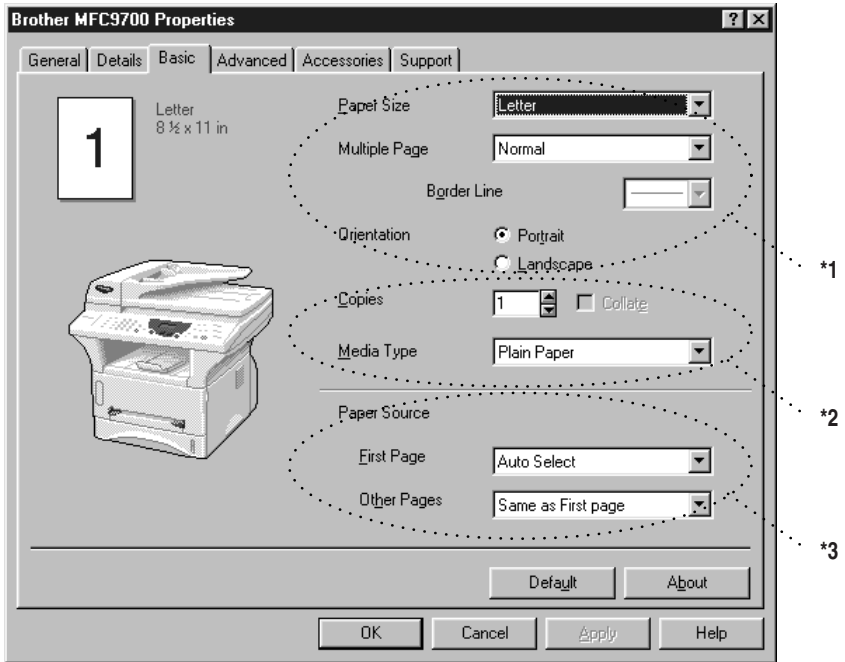

- *1 Select the Paper size, Multiple Page and Orientation.
- *2 Select number of Copies and Media Type.
- *3 Select Paper Source, First Page and Other Pages.

Paper Size

From the drop-down box select the Paper Size you are using.

Multiple Page

The Multiple Page selection can reduce the image size of a page allowing multiple pages to be printed on one sheet of paper or enlarging the image size for printing on page on multiple sheets of paper.

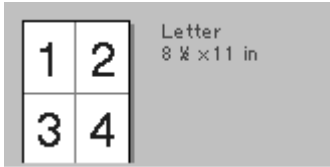

Ex. 4 in 1

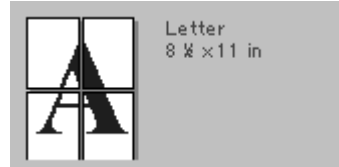

Ex. 1 in 2 x 2 pages

Border Line

When printing multiple pages on one sheet with the Multiple Page feature you can select to have a solid border, dash border or no border around each page on the sheet.

Orientation

Orientation selects the position of how your document will be printed (Portrait or Landscape).

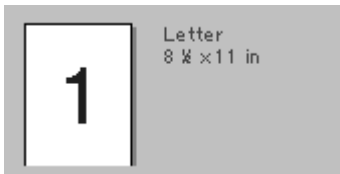

Portrait

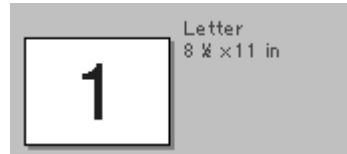

Landscape

Copies

The copies selection sets the number of copies that will be printed.

Collate

The collate selection is active if more than one copy is selected. With the collate check box selected, one complete copy of your document will be printed and then repeated for the number of copies you selected. If the collate check box is not selected then each page will be printed for all the copies selected before the next page in the document is printed.

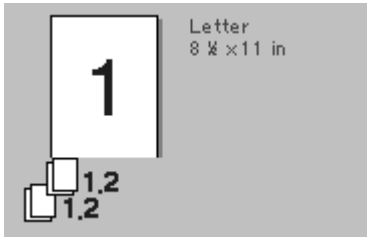

Collate box checked

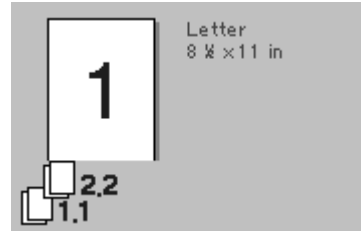

Collate box not checked

Media Type

You can use the following types of media in your printer. For the best print quality, select the type of media that you wish to use.

Plain Paper

Thin Paper

Thick Paper

Thicker Paper

Bond Paper

Transparencies

When using ordinary plain paper, select **Plain Paper**. When using heavier weight paper, envelopes or rough paper select **Thick Paper** or **Thicker Paper**. For bond paper, select **Bond Paper** and for OHP transparencies, select **Transparencies**.

Advanced Tab

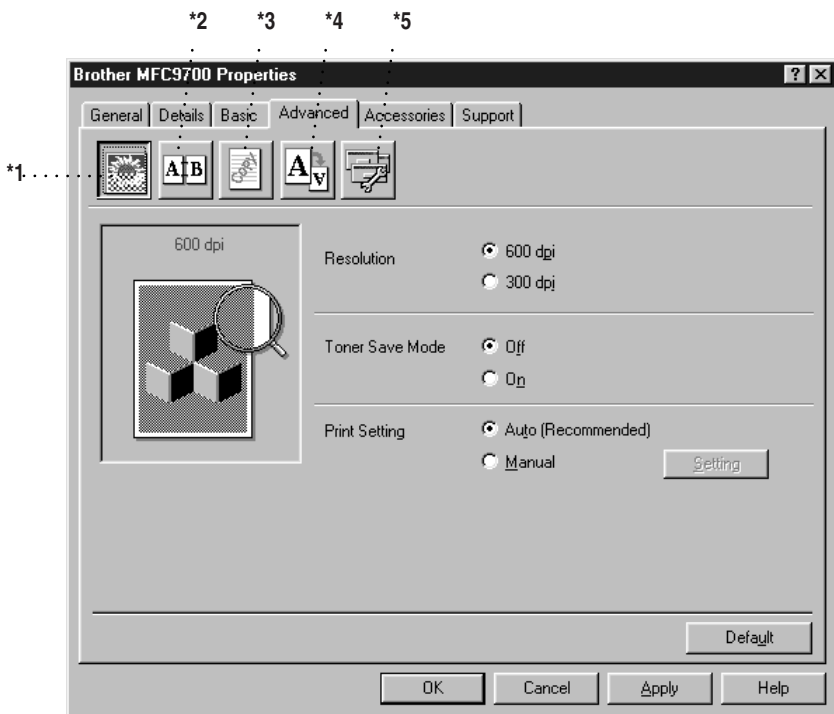

Change the tab settings by selecting one of the following icons:

- *1 Print Quality
- *2 Duplex Printing
- *3 Watermark
- *4 Page Setting
- *5 Device Option

Print Quality (*1)

Resolution

You can change the resolution as follows:

- 300 dpi
- 600 dpi

Toner Save

You can save running costs by turning on the Toner Save Mode, which reduces the print density.

Print Setting (For Windows® 95/98/98SE/Me Users Only)

Print Setting is used for optimizing your print quality for the type of document being printed (Photos, Graphics or Scanned Images). When you choose **Auto (Recommended)**, the printer automatically prints with the most suitable print settings.

With the Print Setting set to Manual, you can change the Brightness, Contrast and Graphics Quality options manually.

Duplex Printing (*2)

Choosing the Duplex Printing icon displays the Manual Duplex features available.

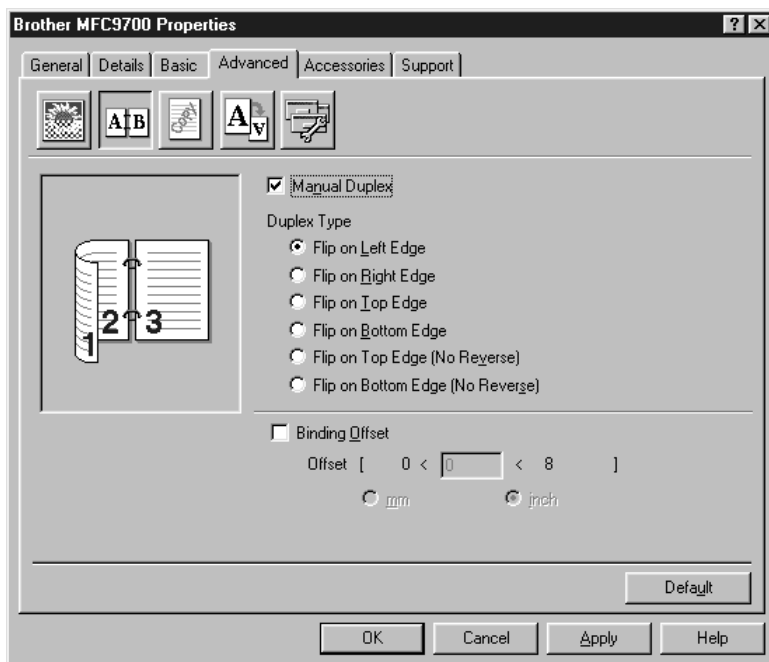

Manual Duplex

Check the Manual Duplex box and there are six types of duplex directions available for each orientation. In this mode, the MFC prints all the even numbered pages first. Then the printer driver stops and shows the instructions required to re-install the paper. When you click OK the odd numbered pages are printed.

Binding Offset

Check the Binding Offset option, you can specify the offset value of the binding side in inches or millimeters (0 - 8 inches) [0 - 203.2 mm].

Watermark (*3)

You can place a logo or text into your document as a Watermark by using a bitmap file as your source file or select one of the preset Watermarks.

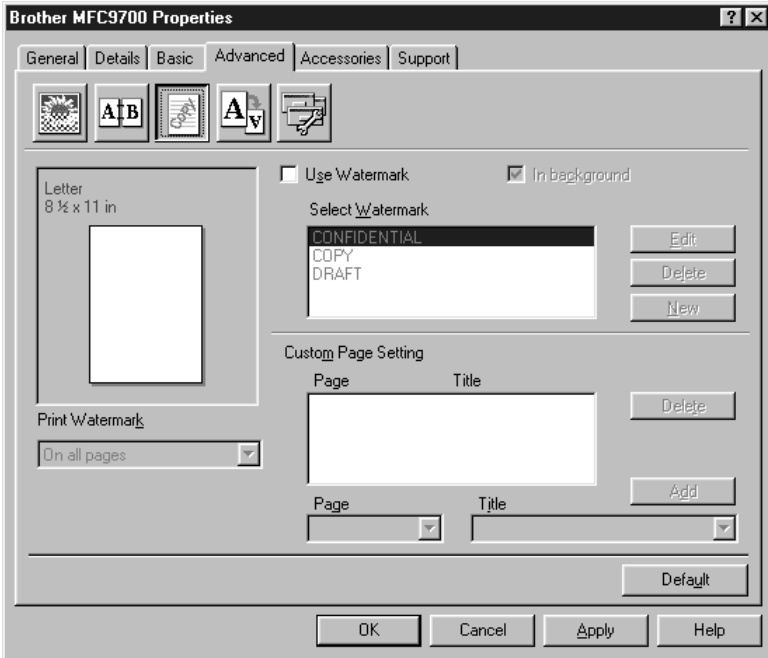

Print Watermark

The Print Watermark feature offers printing choices of:

On all pages

On first page only

From second page

Custom

In background

With the In background feature checked the Watermark will print behind your document on the page. If this feature is not checked then the Watermark will print on top of your document.

You can change the size and the position of the Watermark on the page by selecting the Watermark and clicking the Edit button. If you want to add a new Watermark, click the New button and select Text or Bitmap from the Watermark Style.

Watermark Text

Enter your Watermark text into the Text Box and select the Font, Size, Darkness and Style.

Watermark Bitmap

Enter the file name and location of your bitmap image in the File box or Browse for the file location. You can also set the scaling size of the image.

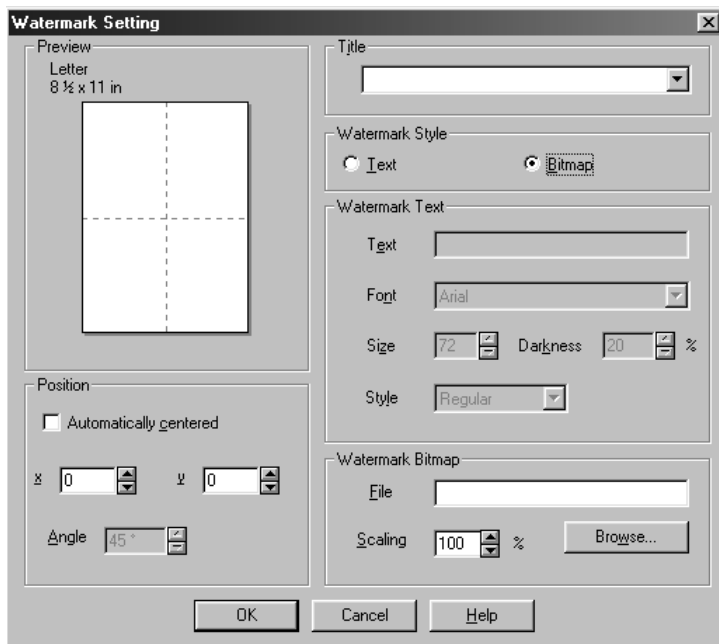

Position

The position settings offer controls on where the Watermark can be positioned on the page.

Page Setting (*4)

You can change the print size of your document with the Scaling feature.

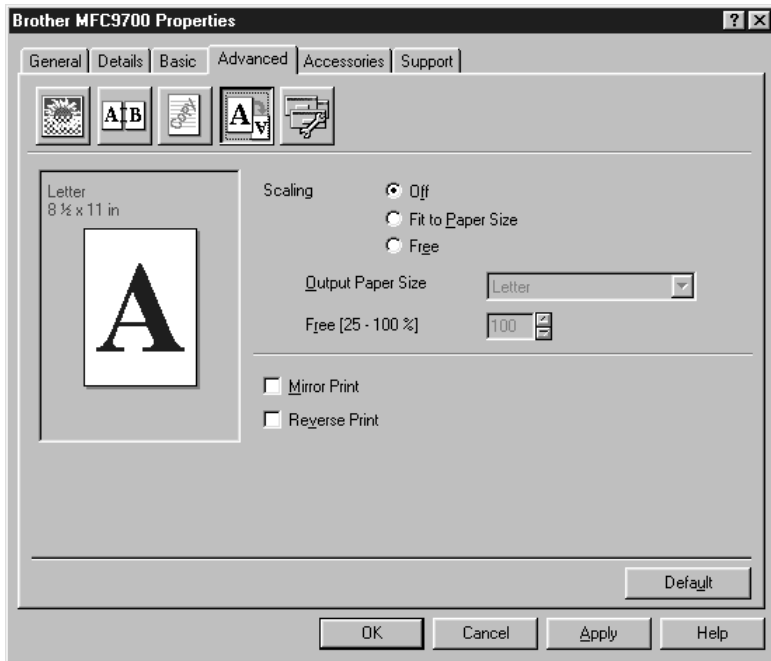

- 1 Check Off if you want to print the document as it appears on your screen.
- 2 Check Fit to Paper Size, if your document has an unusual size, or if you have only the standard size paper.
- 3 Check the Free box if you want to reduce or enlarge the output.

You can also use the Mirror or Reverse Print feature for your page setting.

Device Options (*5)

Set one of the following Printer Functions:

- Quick Print Setup
- Administrator (For Windows® 95/98/98SE/Me Users Only)
- Print Date & Time

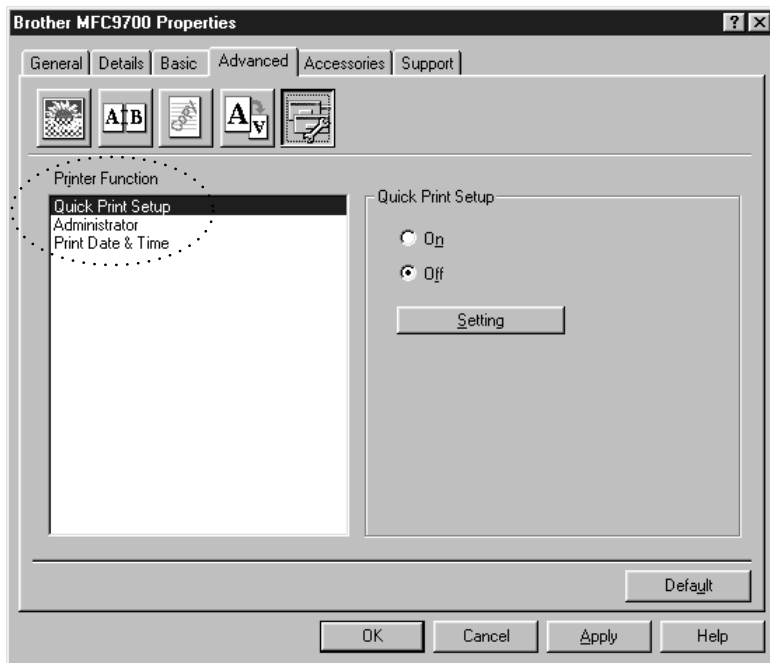

Quick Print Setup

The Quick Print Setup feature allows you to quickly select driver settings. To view setting, simply click your mouse button on the task tray  icon. This feature can be set to ON or OFF from the Device Options section.

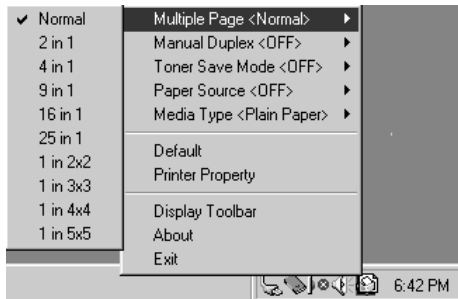

Administrator (For Windows® 95/98/98SE/Me Users Only)

The administrator selection permits the Copy, Scaling and Watermark features to be locked and password protected.

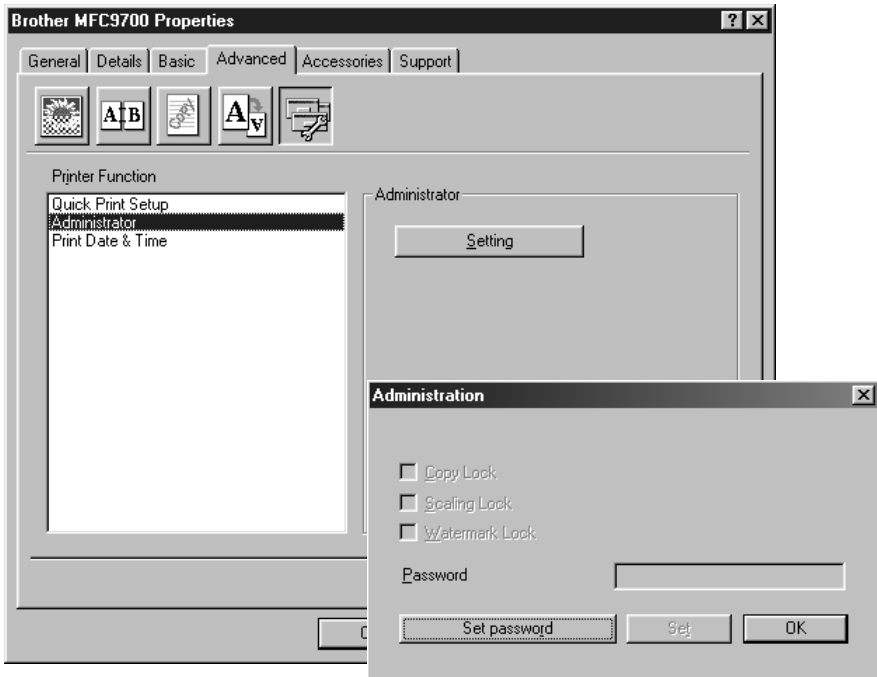

Record your password and keep it in a safe place for future reference. If you forget your password these settings can not be accessed.

Print Date & Time

When enabled the Print Date and Time feature will automatically print the date and time from your computers system clock on your document.

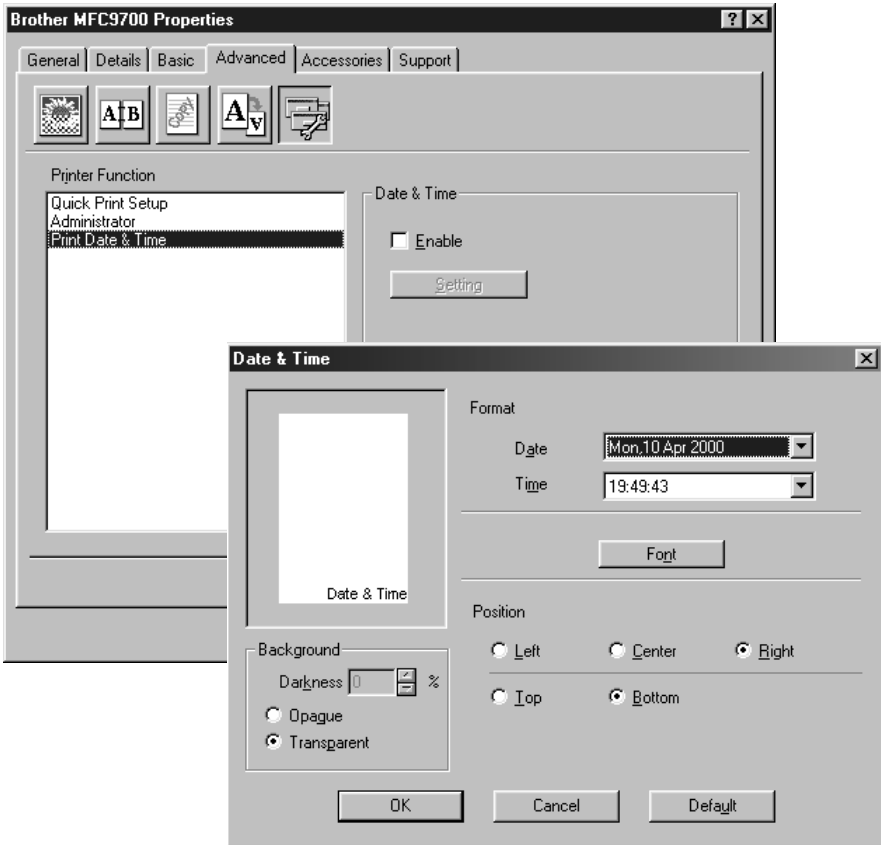

Click the Setting button to change the Date and Time Format, Position and Font. To include a background with the Date and Time select Opaque. When Opaque is selected you can set the Darkness of the Date and Time background by changing the percentage.



The Date and Time indicated in the selection box represents the format the will be printed. The actual Date and Time printed on your document is automatically retrieved from the settings of your computer.

Accessories Tab

The Accessories Tab includes the settings for configuring the printer driver for the size of paper loaded in each paper source. This tab also installs any additional options into the driver settings.

Paper Source Setting

To configure the paper size for each paper source, highlight the source from the **Paper Source Setting** list. Select the **Paper Size** from the pull-down box and click **Update**. (The Paper Source Setting is used when selecting **Auto Select** in the Basic Tab.)

Default Source

The Default Source allows you to choose the paper source that will be used when the paper size of the document being sent does not match the Paper Source settings.

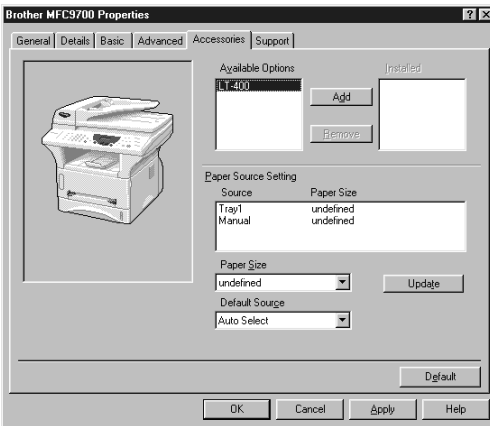

Available Options

In order to access the optional 2nd paper tray the option must be installed in the driver. Highlight the model number from the **Available Options** list and click **Add**. The optional tray will then be listed in the Installed box, Paper Source Setting list and the screen illustration will display the 2nd tray.

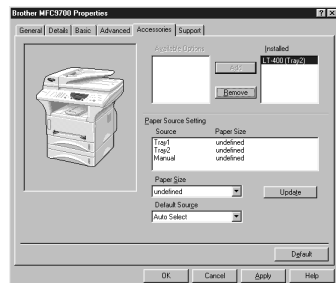

Support

The Support Tab provides driver version information and setting information. In addition there are links to the Brother Solution Center and Driver Update Web sites.

Brother Solutions Center

The Brother Solutions Center is a Web site offering information about your Brother product including FAQ's , User Guides, Driver updates and Tips for using your machine.

Web Update

Web Update checks the brother web site for updated drivers and automatically downloads and updates the driver on your computer.

Check Setting

The Check Setting selection displays a list of your current drivers settings.

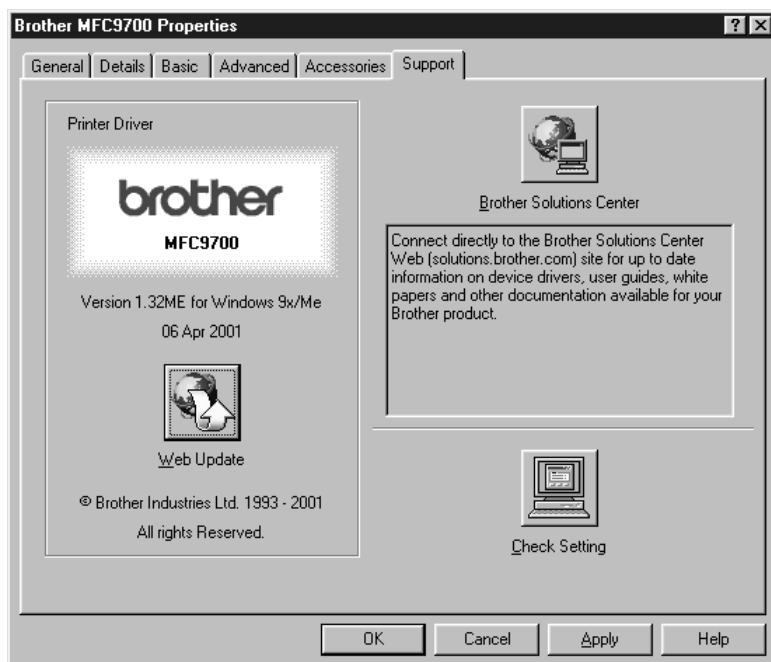

Features in the Printer Driver (For Windows® 2000)

The Windows® 2000 printer driver utilizes Microsoft's uni-driver architecture. The following section describes the driver features and selections available for Windows® 2000.

General Tab

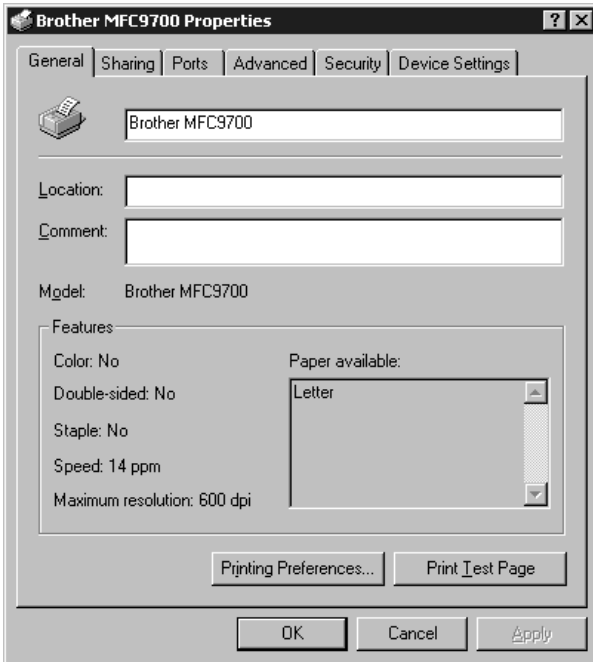

Printing Preferences

In the General tab, click the **Printing Preferences...** button to access the Layout tab.

Layout Tab

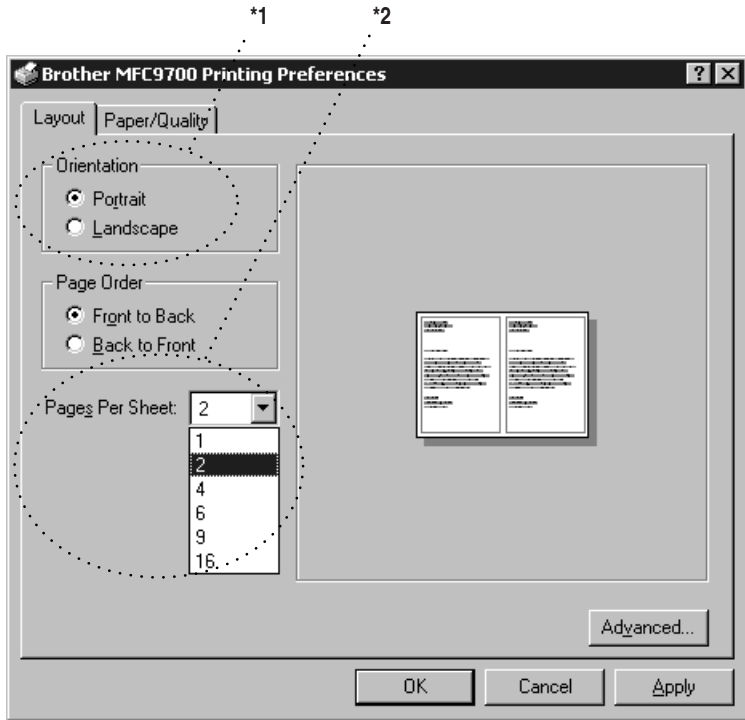

*1 Orientation

Select the Orientation, which is how your document will be positioned on the paper (Portrait or Landscape).



Portrait

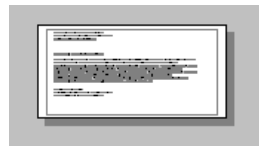

Landscape

*2 Pages Per Sheet

You can select 1, 2, 4, 6, 9 or 16 pages to be printed on one sheet of paper. The image of each page will be reduced as needed to fit on the paper.

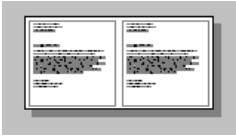

2 in 1

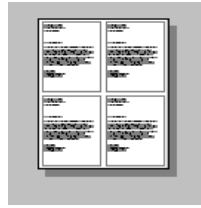

4 in 1

Paper/Quality Tab

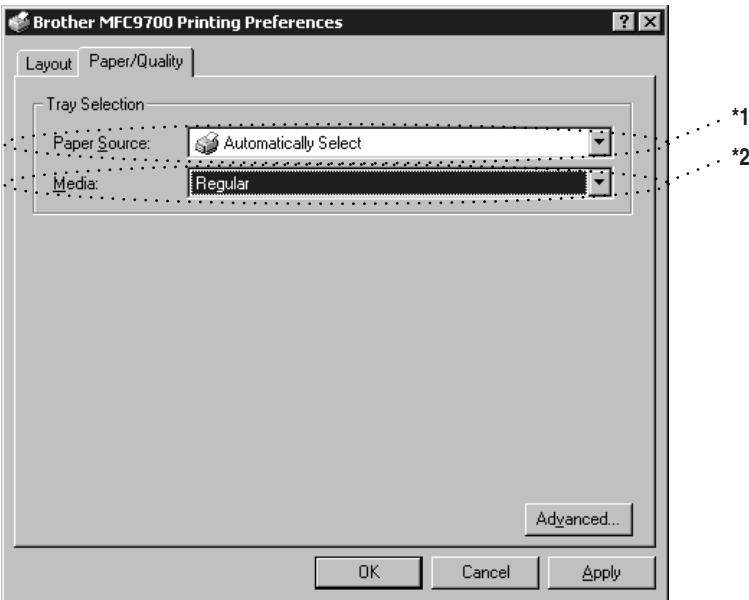

*1 Paper Source

Possible paper sources are: Automatically Select, Auto, Upper Paper Tray, Lower Paper Tray (optional cassette #2) and Manual Feed Slot.

When “Automatically Select” is chosen the MFC automatically will choose the cassette with the appropriate size of paper.



The paper size for each paper source must be set in the Device Settings tab for the Automatically Select feature to work properly.

The “Auto” option is for machines that can automatically detect the size of paper that is loaded in the paper source; Auto is not active for your MFC.

*2 Media

For the best print quality, select the type of media you are using:

Regular

Thick Paper

Thicker Paper

Transparency

When using ordinary plain paper, select Regular. When using heavier weight paper, envelopes, or rough paper, select Thick Paper or Thicker Paper. For OHP transparencies, select Transparency.

Advanced Options

Click the **Advanced...** button in the Paper/Quality tab to access the screen below:

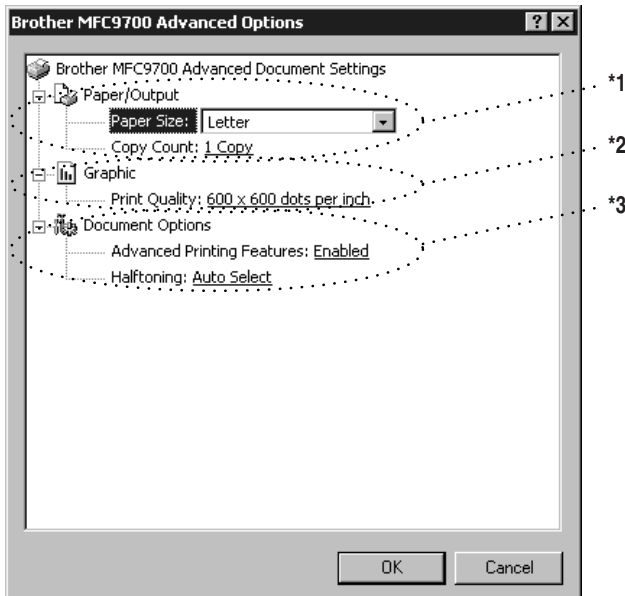

*1 Paper /Output

Paper Size – Select the paper size of the document you are printing. This size should be the same as the paper size that is set in your application software.

Copy Count – Type the number of copies you want.

***2 Graphic**

Print Quality – You can change the resolution as follows:

600 × 600 dots per inch

300 × 300 dots per inch

***3 Document Options**

Advanced Printing Features – You can Enable or Disable Advanced Printing Features from this selection. If you disable it, Page Order, Pages Per Sheet, Copy and Collate will be disabled.

Halftoning – This selection is for changing the dither pattern to achieve the best print results when printing graphics. The choices are as follows:

Auto Select

Super Cell

Dither 6 × 6

Dither 8 × 8

Device Settings Tab

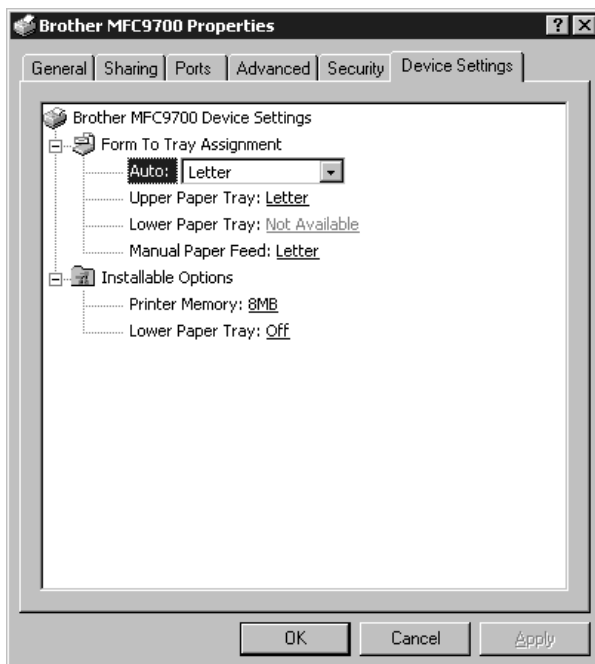

Form To Tray Assignment – This selection assigns the paper size to each paper source. For auto paper selection (Automatically Select) to work properly, the paper size set for each source must match the actual size of paper loaded.

The available options are:

- A4
- A5
- B5 (JIS)
- Executive
- Legal
- Letter

Installable Options

Printer Memory – If you installed optional memory into your MFC, you must select the correct size of total memory in the MFC for the driver to access the additional memory.

Lower Tray – If an optional lower tray is installed, this selection must be set to ON to enable access to the lower tray.

15 Using the Windows®-Based Brother MFL-Pro Control Center

Brother Control Center

The Brother Control Center is a software utility that pops up on the PC screen whenever paper is placed in the automatic document feeder (ADF). This allows you to quite easily, with very few mouse clicks, access the most frequently used scanning applications. Using the Control Center eliminates the need to manually launch the specific applications.

The Brother Control Center provides three categories of functions:

- 1 Scanning directly to a file, E-mail, word processor or graphic application of choice
- 2 Copy operations
- 3 PC Faxing using the Brother PC Fax software

MFC-9700:





AutoLoad the Brother Control Center

The Control Center is initially configured to automatically load each time Windows® is started. When the Control Center is loaded, the Control Center  icon will appear in the task bar. If you don't want the Control Center to load automatically, you can turn off AutoLoad.

If the Control Center  icon does not appear in your task bar, you will have to install this software.

From the **Start** menu select **Programs, Paper Port**, and then double-click **Brother SmartUI PopUp**.

How to Turn Off AutoLoad

- 1 Left-click the Control Center  icon, and then click **Show**.
- 2 When the Control Center icon appears, left-click the Smart Click  Control Center button. A dialogue box with a check box labeled “AutoLoad Pop-up” will appear:

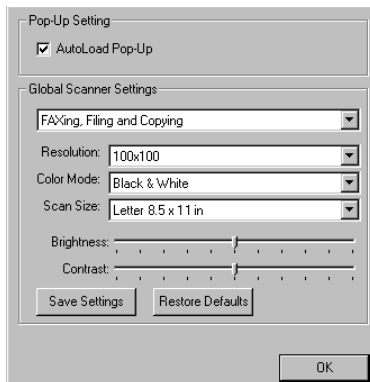

- 3 Uncheck the AutoLoad Pop-Up option.

Using the Scan Keys

You can use the Scan keys on the control panel to scan originals into your word processing, graphics or E-mail applications. The advantage of using the Scan keys is that you avoid the mouse clicks required to scan from your PC.

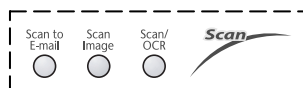

Using the Control Panel Keys

-  If you have connected a Macintosh, the control panel keys will not work with your computer.

Before you can use the Scan keys on the control panel, you must have connected the MFC to your Windows[®]-based PC and loaded the appropriate Brother Drivers for your version of Windows[®]. When you are ready to use the Scan keys, make sure the Brother Control Center application is running on your PC. (For details about how to configure the Brother Control Center buttons to launch the application of your choice using the Scan keys, see *Brother Control Center Features*, Page 15-4 to15-6.)

Scan Image

You can scan a picture into your graphics application for viewing and editing.

- 1 Place your original face up in the ADF, or face down on the scanner glass.
- 2 Press **Scan Image**.

The MFC will scan the original and send a color image to your graphics application.

Scan/OCR

If your original is text, you can have it automatically converted by ScanSoft™ TextBridge® to an editable text file and then displayed in your word processing application for further editing.

- 1 Place your original face up in the ADF, or face down on the scanner glass.
- 2 Press **Scan/OCR**.
- 3 The MFC will scan the original perform OCR in ScanSoft™ TextBridge® and then display the result in your word processing application for viewing and editing.

Scan to E-mail

You can scan an original into your E-mail application as a file attachment. Although the Brother Control Center can be configured to send only black and white or color file attachments at one time, you can easily change this setting. (For details see *Scan to E-mail, Page 15-8 to 15-10.*)



- 1 Place the original face up in the ADF, or face down on the scanner glass.
- 2 Press **Scan to E-mail**.
- 3 The MFC will scan the original, create a file attachment, and launch your E-mail application, displaying the new message waiting to be addressed.

Brother Control Center Features

Auto Configuration

During the installation process the Control Center checks your system to determine the default applications for E-mail, word processing and graphics viewer/editor. For example, if you are using Outlook as your default E-mail application, the Control Center automatically will create a link and a scanning application button for Outlook.

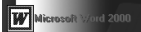
You can change a default application by right-clicking any of the scan buttons in the Control Center and selecting a different application. For example,

you can change a scan button from MS Word  to MS Word Pad  by changing the application that is listed for the Word Processor.



Scanning Operations

Scan to File—allows you to scan directly to a disk file with two mouse clicks. You can change the file type, destination directory and file name, as needed.

Scan to E-mail—enables you, with just two mouse clicks, to scan a picture or text document directly into an E-mail application as a standard attachment. You have the option of selecting the file type and resolution for the attachment.

Scan to Word Processor—enables you to scan a text document, run ScanSoft TextBridge OCR and insert the text original (not graphic image) into a word processing file with just two mouse clicks. You have the option of selecting the destination word processing program, such as Word Pad, MS Word, Word Perfect, etc.

Scan to Graphic Application—allows you to scan an image directly into any graphic viewer/editor application. You can select the destination application, such as MS Paint or Corel PhotoPaint.

Copy Operations

Copy—allows you to use the PC and any Windows® printer driver for enhanced copy functions. You can scan the page on the Brother MFC and print the copies using any of the features of the Brother MFC printer driver—**OR**—you can direct the copy output to any standard Windows® printer driver installed on the PC.

PC Fax Operation

Send a Fax—allows you to scan a picture or text original and automatically send the image as a fax from the PC using the Brother MFL Pro fax software.

Scanner Settings for Scan, Copy and PC Fax Buttons

When the Pop-Up screen is displayed, you can access the Scanner Settings window.

Click the Smart Click  icon at the top right of the Brother Control

Center screen—**OR**—Click the **Modify Settings...** button on any of the Configuration screens.

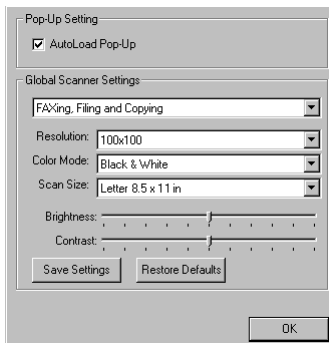

Global Settings

AutoLoad Pop-Up—Click this checkbox if you want Brother MFL Control Center to load when you boot your computer.

Setting Up the Scanner Configurations

The Pop-Up application stores eight different scanning modes. Each time you scan an original, you will choose the most appropriate scanning mode from the following:

Faxing, Filing and Copying

Text for OCR

Photos

Photos (High Quality)

Photos (Quick Scan)

Custom

Draft Copy

Fine Copy

Each mode has its own set of stored settings. You can keep the factory default settings or change them at any time:

Resolution—Select the scanning resolution you most frequently use.

Color Mode—From the pull-down list, select

Scan Size—From the pull-down list, select

Brightness—Slide the adjuster from 0% to 100%

Contrast—Slide the adjuster from 0% to 100%

Click **OK** to save your changes. If you make a mistake or later decide to return to the original default setting, just click the **Restore Defaults** button when the scanning mode is displayed.

To Access the Scanner Configuration Screen:

- 1 Place the original in the ADF.
- 2 Right-click the appropriate Control Center button to display *Configurations...*, then click it. The configuration screen for that **Control Center** button will appear.
- 3 To save your settings, press the **OK** button—**OR**—To return to the factory default settings, press the **Restore Defaults** button.

Perform an Operation from the Control Center Screen

If you see this screen it means you left-clicked a button in the Control Center window without first placing an original in the ADF.

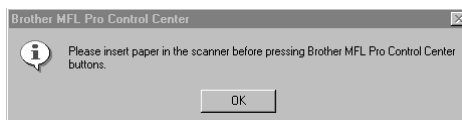

Place the original in the Brother machine's ADF, and then click **OK** to return to the Control Center screen.



If you want to scan the document from the scanner glass, please use Scan keys on the control panel.

Scan to File

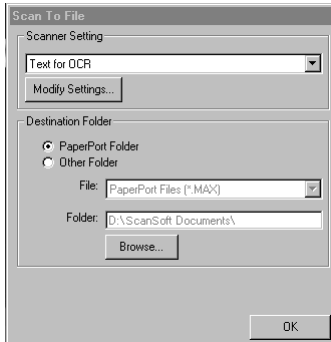

Scanner Settings

From the pull-down list, select the scanning mode that is appropriate for the type of file: Faxing, Filing and Copying; Text for OCR; Photos; Photos (High Quality); Photos (Quick Scan); Custom; Draft Copy or Fine Copy.

To change any of the settings for that mode, click the **Modify Settings...** button.

Destination Folder

PaperPort Folder—Select this checkbox to scan the original into your PaperPort folder.

Other Folder—Select this checkbox, to scan the original as another file type and/or into another directory/folder.

File—If you selected Other Folder, from the pull-down list select the type of file:

- PaperPort Files (*.MAX)*
- Self Viewing Files (*.EXE)*
- PaperPort 5.0 Files (*.MAX)*
- PaperPort 4.0 Files (*.MAX)*
- PaperPort 3.0 Files (*.MAX)*
- Windows Bitmap (*.BMP)*
- PC Paintbrush (*.PCX)*
- Multi-page PCX (*.DCX)*
- JPEG Image Files (*.JPG)*
- TIFF-Uncompressed (*.TIF)*
- TIFF Group 4 (*.TIF)*
- TIFF Class F (*.TIF)*
- Multi-Page TIFF-Uncompressed (*.TIF)*
- Multi-Page TIFF Group 4 (*.TIF)*
- Multi-Page TIFF Class F (*.TIF)*
- PDF Files (*.PDF)*
- Portable Network Graphics (*.PNG)*
- FlashPix (*.FPX)*
- HFX Fax Files (*.HFX)*

To Search your system for the directory and folder you want, click the **Browse...** button. Click **OK** to save your settings.

Scan to E-mail

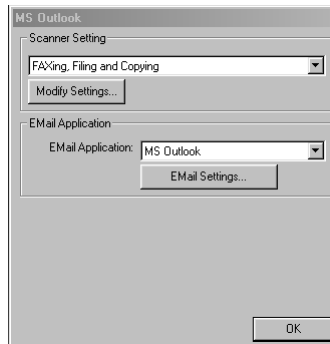

Scanner Settings

From the pull-down list, select the scanning mode that is appropriate for the type of file: Faxing, Filing and Copying; Text for OCR; Photos; Photos (High Quality); Photos (Quick Scan); Custom; Draft Copy or Fine Copy.

To change any of the settings for that mode, click the **Modify Settings...** button.

E-mail Application

E-mail Package—From the pull-down list, select your E-mail application.

E-mail Settings—Click the **E-Mail Settings...** button to set up links.

The Links Preferences window will appear:



File Attachments

Do not convert files—Click this checkbox if you do not want to change the file type of attachments. The Conversion Options will not be available (grayed).

Convert MAX files only—Click this checkbox if you want to convert only attachments that are PaperPort files.

Convert all files when possible—Click this checkbox if you want to change the file type of all attachments.

Conversion Options

Format

Combine all files into one file when possible—Click this checkbox to combine all files of the same type into one file.

(For Brother Color Models Only)

Convert non-image files to color—Click this checkbox to convert all files that have been processed through OCR to color.

Show QuickSend Menu

Click this checkbox if you want the Select QuickSend Recipient window to be displayed when you choose Scan to E-mail. This feature works only with MAPI type E-mail applications, such as Microsoft Exchange, Microsoft Outlook and Eudora.

QuickSend List

You can create a list of Email names and addresses for quick selection.

To add a name(s) to your QuickSend list, click the **New** button. Your Email phone book listing will be displayed, so you can select stored names or create new ones:

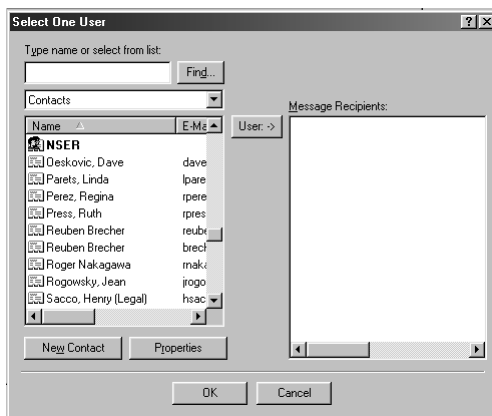

Highlight the name(s) you want to add to your list, and then click the **User** button. Click **OK** to return to the Link Preference window.

To remove a name from the QuickSend list, in the Link Preference window highlight the name and click the **Delete** button.

Scan to Word Processor



Scanner Settings

From the pull-down list, select the scanning mode that is appropriate for the type of file: Faxing, Filing and Copying; Text for OCR; Photos; Photos (High Quality); Photos (Quick Scan); Custom; Draft Copy or Fine Copy.

To change any of the settings for that mode, click the **Modify Settings...** button.

Word Processor

Word Processor—From the pull-down list, select the word processor you want to use.

Click the **Link Settings...** button to display a screen to set up a link to the version of OCR and document format that you want to use:

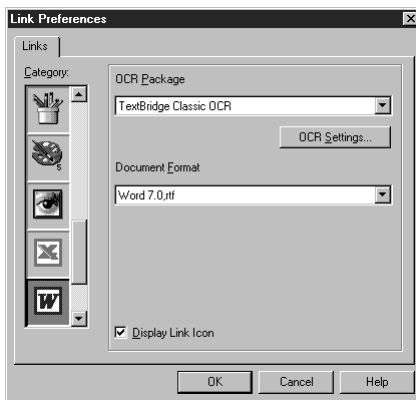

OCR Package—From the pull-down list, select *TextBridge Classic OCR* if you want to use the OCR package that was installed with the Brother software.

Click the **OCR Settings...** button to choose how the OCR application will read the pages you scan into your word processor application.

The Preferences window will appear:

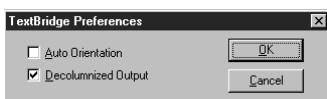

Select your setting and click **OK**.

- *Auto Orientation*—Check this checkbox if you want your word processor application to read the page as it is set up.
- *Decolumnized Output*—Check this checkbox if you want your word processor application to read across the entire page from left to right.
- *Document Format*—From the pull-down list, select the file format you want to use for your word processor or text documents.

User-Defined Button

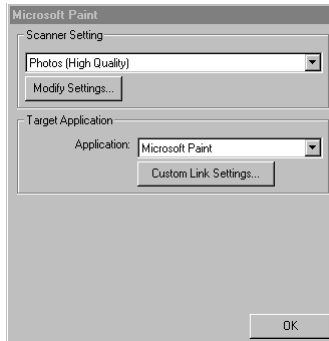

Scanner Settings

From the pull-down list, select the scanning mode that is appropriate for the type of file: Faxing, Filing and Copying; Text for OCR; Photos; Photos (High Quality); Photos (Quick Scan); Custom; Draft Copy or Fine Copy.

To change any of the settings for that mode, click the **Modify Settings...** button.

Target Application

Application—From the pull-down list, select the application you want to add to this Pop-Up screen.

Click the **Custom Link Settings...** button to set up links for your user-defined application.

Copy

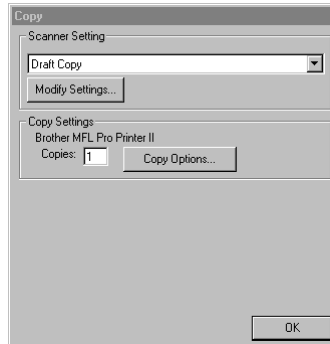

Scanner Settings

From the pull-down list, select the scanning mode that is appropriate for the type of file: Faxing, Filing and Copying; Text for OCR; Photos; Photos (High Quality); Photos (Quick Scan); Custom; Draft Copy or Fine Copy.

To change any of the settings for that mode, click the **Modify Settings...** button.

Copy Settings

Brother MFC-9700

Copies—Enter the number of copies you want to print.

To change the copy options, click the **Copy Options...** button.

Click the **OK** button to save your Copy settings.

Send a Fax



Scanner Settings

From the pull-down list, select the scanning mode that is appropriate for the type of file: Faxing, Filing and Copying; Text for OCR; Photos; Photos (High Quality); Photos (Quick Scan); Custom; Draft Copy or Fine Copy.

To change any of the settings for that mode, click the **Modify Settings...** button.

Fax Settings

Brother MFL Pro Fax

FAX Resolution—Fine (200 × 200).

To change the fax options, click the **FAX Options...** button.

Click the **OK** button when you are ready to save your FAX settings.

The Brother PC-FAX Properties screen appears:

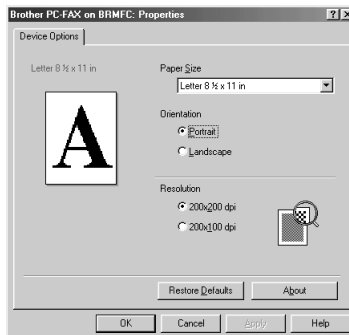

Select the *Paper Size and Orientation* (Portrait or Landscape) and click **OK**.

To return to the factory default settings, click the **Restore Defaults** button.

16 Using ScanSoft™ PaperPort® for Brother and ScanSoft™ TextBridge® (For Windows® Only)

Using ScanSoft™ PaperPort® and TextBridge®

ScanSoft™ Paper Port® for Brother is a document management application. You will use PaperPort® to view incoming faxes and scanned documents. PaperPort® has a sophisticated, yet easy-to-use, filing system that will help you organize your documents. It allows you to combine or “stack” documents of different formats for printing, faxing or filing. PaperPort® can be accessed through the PaperPort® program group. See *On-Line Documentation for Multi-Function Link® Pro* on the CD-ROM.

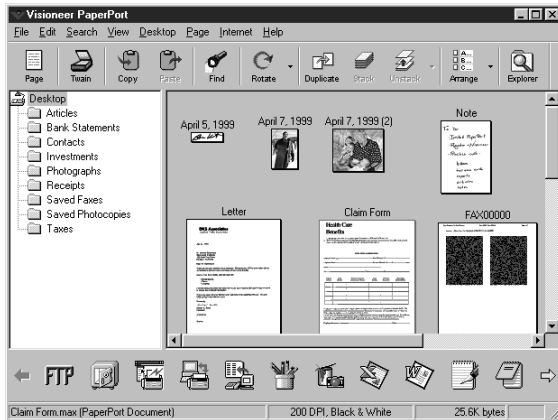

The complete ScanSoft™ PaperPort® Owner’s Manual, including ScanSoft™ TextBridge® OCR, is in the On-Line Documentation on the CD-ROM. This chapter is only an introduction to the basic operations.

When you install Multi-Function Link® Pro, ScanSoft™ PaperPort® for Brother and ScanSoft™ TextBridge® OCR are installed with it automatically.



To Uninstall PaperPort® and ScanSoft™ TextBridge

For Windows® 95/98/98SE, and Windows NT® Workstation 4.0, Windows® ME and Windows® 2000 Professional:

Select Start, Settings, Control Panel, Add/Remove Programs and the Install/Uninstall tab. Select PaperPort® from the list and click the Add/Remove button.

Viewing Items in ScanSoft™ PaperPort® for Brother

PaperPort® provides several ways to view items: **Desktop View** displays a **thumbnail**, a small graphic that represents each item in a Desktop or folder. Items in the selected folder appear on the PaperPort® Desktop. You can see PaperPort® items (MAX files) and non-PaperPort® items (files created using other applications).

Non-PaperPort® items include an icon that indicates the application that was used to create the item; a non-PaperPort® item is represented by a small rectangular thumbnail and not an actual image.

Page View displays a close-up of a single page and you can open a PaperPort® item by double-clicking on it. As long as you have the appropriate application on your computer to display it, you can also double-click a non-PaperPort® item to open it.

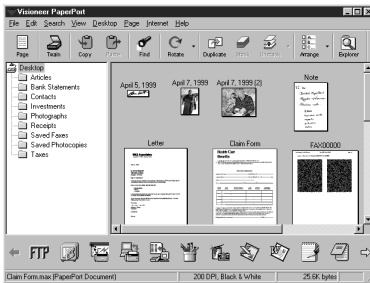

Desktop View displays items as thumbnails

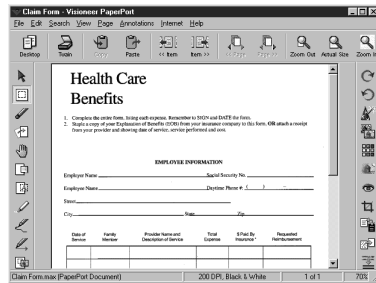

Page View displays each item as a full page

Organizing Your Items in Folders

PaperPort® has an easy-to-use filing system for organizing your items. The filing system consists of folders and items that you select to view in Desktop View. An item can be a PaperPort® item or a non-PaperPort® item:

- Folders are arranged in a “tree” structure in the Folder View. You use this pane to select folders and view their items in Desktop View.
- You can simply drag and drop an item onto a folder. When the folder is highlighted, release the mouse button and the item is stored in that folder.
- Folders can be “nested”—that is, stored in other folders.
- When you double-click a folder, its items (both PaperPort® MAX files and other files) appear on the Desktop.
- You can also use Windows® Explorer to manage the folders and items shown in Desktop View.

Links to Many Other Applications

PaperPort® automatically recognizes many other applications on your computer and creates a “working link” to them. The Link Bar at the bottom of Desktop view shows icons of those linked applications. To use a link, drag an item onto one of the icons to start the application represented by the icon. A typical use of the Link Bar is to select an item and then fax it.

This sample Link Bar shows several applications with links to PaperPort®.



If PaperPort® does not automatically recognize one of the applications on your computer, you can manually create a link using the **Create New Link** command. (See *PaperPort® Help* for more information about creating new links.)

Using ScanSoft™ TextBridge® OCR (Converting Image Text to Text You Can Edit)

Software by:



ScanSoft™ TextBridge® OCR is automatically installed with PaperPort® when you install Multi-Function Link® Pro on your computer.

PaperPort® can quickly convert the text on a PaperPort® item (which is really just a picture of the text) into text that you can edit with a word processing application. PaperPort® uses the optical character recognition application ScanSoft™ TextBridge, which comes with PaperPort®—**OR**—PaperPort® uses your application if it is already on your computer. You can convert the entire item, or by using the **Copy As Text** command, you can select only a portion of the text to convert.

Dragging an item onto a word-processing link icon starts PaperPort®’s built-in OCR application, or you can use your own OCR application.



Importing Items from Other Applications

In addition to scanning items, you can bring items into PaperPort® in a variety of ways and convert them to PaperPort® (MAX) files in several different ways:

- Print to the Desktop View from another application, such as Microsoft Excel.
- Import files saved in other file formats, such as Windows® Bitmap (BMP) or Tag Image File Format (TIFF).

Exporting Items in Other Formats

You can export or save PaperPort® items in several popular file formats. For Windows® 95/98/98SE, and Windows NT® Workstation Version 4.0, Windows® 2000 Professional and Windows® ME, you can export formats BMP, PCX, DCX, JPG, TIF, PDF, PNG, FPX, HFX, or self-viewing. For Windows® 3.1x, you can export file formats BMP, PCX, DCX, JPG, TIF, PDF, HFX and GIF. For example, you could create a file for an Internet Web site and export it as a JPEG file. Web pages often use JPEG files for displaying images.

Exporting an Image File

- 1 Select the Export command from the File pull-down menu in the PaperPort® window. The Export ‘XXXXX’ As dialog box will be displayed.
- 2 Select the drive and directory where you want to store the file.
- 3 Enter the new file name and choose the file type or select a name from the File Name text box. (You can scroll through the Directories and File Name listing for prompting.)
- 4 Select the **OK** button to save your file, or **Cancel** to return to the PaperPort® without saving it.

Accessing the Scanner

To choose the **Brother MFL Pro® Color** as your scanner driver, select it under the “Select scanner”—**OR**—“Select source” option in your software.

From the PaperPort® window, select **Acquire** from the File drop-down menu or select the **TWAIN** or **Scan** button. The Multi-Function Link® Pro Scanner Setup dialog box will appear:

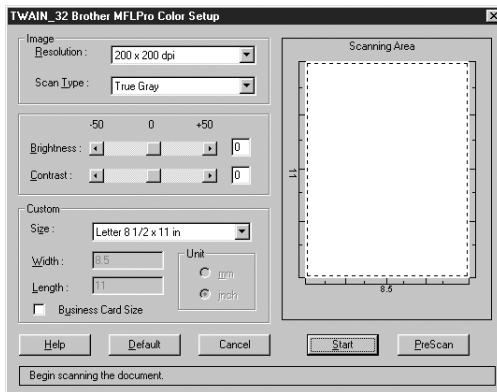

Scanning an Image into Your PC

- 1 Insert document(s) face up in the ADF, or face down on the scanner glass.
- 2 Adjust the following settings, if needed, in the Scanner Setup window:
 - Resolution
 - Scan Type (Black & White, Gray [Error Diffusion], True Gray, 256 color, 24 bit color, 24 bit color (Fast))
 - Brightness
 - Contrast
 - Size
- 3 Select the **Start** button from the Scanner window.

When scanning is completed, close the scanner window. The PaperPort® screen will appear showing the image you scanned highlighted in red.

Settings in the Scanner Window

Image

Resolution

Resolution: Select the scanning resolution from the Resolution drop down list. Higher resolutions take more memory and transfer time, but can achieve a finer scanned image.



When the setting is True Gray, 200 × 100 dpi and 200 × 400 dpi is not available.

Scan Type

Black & White: Set the image Type to Black & White for text or line art. For photographic images, set the image type to Gray (Error Diffusion) or True Gray.

Gray (Error Diffusion) is used for documents that contain photographic images or graphics. (Error Diffusion is a method for creating simulated gray images by placing black dots in a specific matrix instead of true gray dots.)

Colors: Choose either 256 Color, which scans up to 256 colors, 24-bit color, which scans up to 16.8 million colors. Although using 24-bit color creates an image with the most accurate colors, the image file will be approximately three times larger than a file created with 256 Color.

Brightness

Brightness: Adjusting the brightness settings to obtain the best image. The Brother Multi-Function Link® Pro offers 100 brightness settings (-50 to 50). The default value is 0, representing an “average” setting.

You can set the brightness level by dragging the sidebar to the right to lighten the image or to the left to darken the image. You can also type a value in the box to set the settings.

If the scanned image is too light, set a lower brightness value and scan the document again.

If the image is too dark, set a higher brightness value and scan the document again.

Contrast

The contrast setting is adjustable only when you have selected one of the gray scale settings, but it is not available when Black & White is selected as the gray Scale.

Increasing the contrast level (by dragging the slider to the right) emphasizes dark and light areas of the Image, while decreasing the contrast level (by dragging the slider to the left) reveals more detail in gray areas. Instead of using the slider, you can type a value in the box to set the contrast.

Custom

Size

Set the Size to one of the following:

- Letter (8 1/2 × 11 in.)
- A4 (210 × 297 mm.)
- Legal (8 1/2 × 14 in.)
- A5 (148 × 210 mm.)
- B5 (182 × 257 mm.)
- Executive (7 1/4 × 10 1/2 in.)
- Business Card (60 × 90 mm.)
- Custom (User adjustable from 0.35 × 0.35 in. to 8.5 × 14 in.)

After you select a custom size, you can adjust the scanning area further by using the left mouse button to drag the dotted outline of the scanning area. This is required when you want to crop an image when scanning.

Business Card Size

To scan business cards, select the Business Card (60 × 90 mm.) size setting and place the business card at the top center of a carrier sheet.



Carrier sheets are available from your Dealer.

When scanning photographs or other images for use in a word processor or other graphics application, you should try different settings for the contrast, mode and resolution to see which settings best suit your needs.

PreScanning an Image

PreScanning allows you to scan an image quickly at a low resolution. A thumbnail version of the image will appear in the Scanning Area. This is only a preview of the image so you can see how it will look. The PreScan button is used to preview an image for cropping any unwanted portions from the image. When you are satisfied with the preview, select the **Start** button to scan the image.

- 1 Insert document face up in the ADF, or face down on the scanner glass.
- 2 Click the **PreScan** button:

The entire document will be scanned into the PC and will appear in the Scanning Area of the Scanner window.

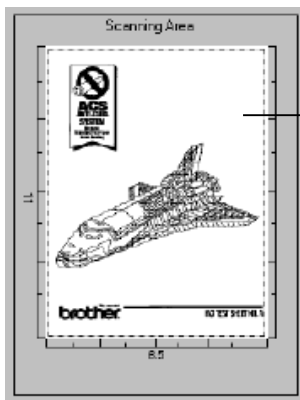

You can crop the prescanned image

- 3 To crop a portion of the document to be scanned, drag any side or corner of the dotted outline in the Scanning Area with the left mouse button. Adjust the dotted outline until it surrounds only the portion of the document you wish to scan.
- 4 Place the original face up in the ADF again, if you used the ADF in Step 1.
- 5 Adjust the settings for Resolution, Color Type (Scan Type), Brightness, Contrast, and Size in the Scanner Setup window, as needed.
- 6 Select the **Start** button.

This time only the selected area of the document will appear in the PaperPort® window.
- 7 In the PaperPort® window, use the options available in the Markups pull-down menu and the Crop option in the Options pull-down menu to refine the image.

17 Setting Up and Using PC-FAX

(For Windows® Only)

Introduction

This chapter outlines the basics of the Brother software, so you can get started using the Multi-Function Link® Pro software. Detailed installation and setup instructions are in the On-Line Documentation section of the Brother CD-ROM that is included with your MFC.

Check the online **README.WRI** file in the root directory of the CD-ROM for last-minute important information and troubleshooting tips that were not included in the On-Line Documentation.

Multi-Function Link® Pro software for your MFC includes ScanSoft™ PaperPort® for Brother and ScanSoft™ TextBridge®. (See Chapter 16, *Using ScanSoft™ PaperPort® for Brother and ScanSoft™ TextBridge® (For Windows® Only)*.)

Brother Resource Manager

The Brother Resource Manager application must be running for you to use your MFC with your Windows® computer. Multi-Function Link® Pro Suite software and the MFL Pro Printer Driver automatically load the Resource Manager, as needed. The Resource Manager allows the single bi-directional Parallel port on the MFC to simulate a Communications port for faxing and scanning and to simulate a Parallel port for Windows® GDI printing.

MFC Remote Setup

The MFC Remote Setup application allows you to quickly set up your machine by taking advantage of the ease and speed of programming on your PC. When you access this application, the settings on your machine will be downloaded automatically to your PC and displayed on your computer screen. If you change the settings, you can upload them directly to the machine.

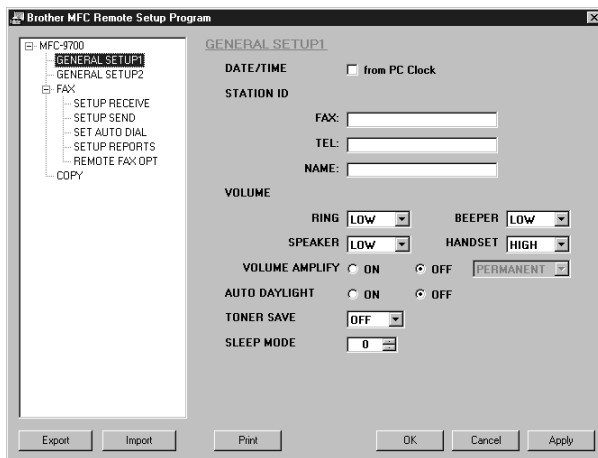

OK

This starts the process of uploading the data to the machine and exiting the remote setup program. If an error message is displayed enter the correct data again, then click **OK**.

Cancel

This exits the remote setup application without uploading the data to the machine.

Apply

This uploads the data to the machine, but does not exit the remote setup application.

Print

This command prints the selected items on the machine. You can not print the data until it is uploaded to the machine. Click **Apply** to upload the new data to the machine and click **Print**.

Export

This command saves the current configuration settings to a file.

Import

This command reads the settings from a file.

PC FAX Sending (For Windows® Only)

The Brother PC FAX feature allows you to use your PC to send a file. You can create a file in any application on your PC, and then send it as a PC FAX. You can even attach a cover page note. All you have to do is set up the receiving parties as Members or Groups in your PC FAX Address Book. Then you can use the Address Book Search feature to quickly find them to address your fax.

Setting Up User Information

- 1 Access the User Information from the FAX Sending dialog box by clicking



—OR—

From the **Start** menu, select **Programs, Brother, Brother MFL Pro Suite**, and then select **PC-FAX Setting**.

The Brother PC-FAX Setup dialog box will appear:

Brother PC-FAX Setup [?] [X]

User Information | Sending | Speed Dial (Facsimile style only)

Name:

Company:

Department:

Phone Number:

Fax Number:

E-mail:

Address 1:

Address 2:

OK Cancel

- 2 Enter the required User information. This information is required to create the Fax Header and Cover Page.
- 3 To save the User Information, click **OK**.

Setting Up Sending

To access the Sending tab from the Brother PC-FAX Setup dialog box by clicking the **Sending** tab.

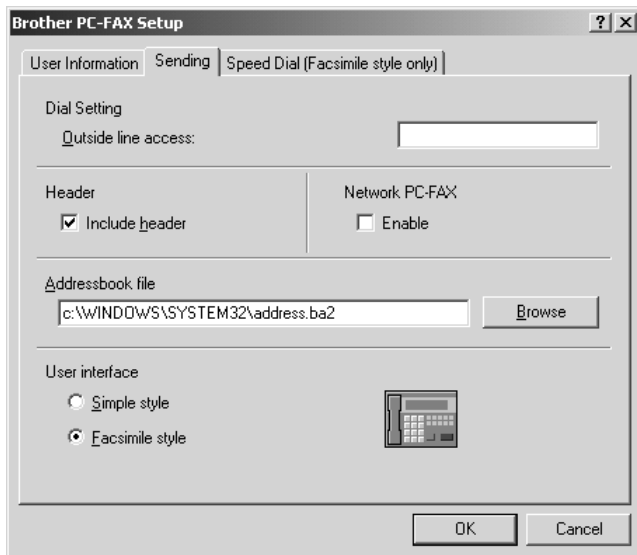

Outside Line Access

Enter the number needed to access an outside line. This is sometimes required by the local PBX telephone system.

Include Header

To add header information to the top of the fax pages being sent, check the Header box.

Address Book File

You can select different database files for use with the Address Book. You must enter the path and file name of the database file or use the Browse button to view the file system to select the file.

Internet PC-FAX

You can use the Internet PC-FAX if you have the optional NC-8100h network board. When you use it, check the Enable box. (See Chapter 14 in NC-8100h User's Guide.)

User interface

To select User Interface for the sending dialog box. You have a choice of the Simple Style or the Facsimile Style.

Simple Style

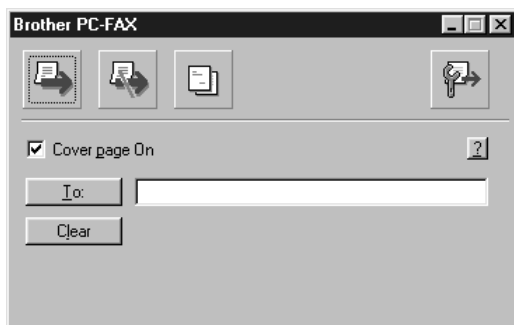

Facsimile Style



Setting Up Speed Dial

Access the Speed Dial tab from the Brother PC-Fax Setup dialog box by clicking the **Speed Dial** tab. (To use the feature you must select the Facsimile Style user interface.)

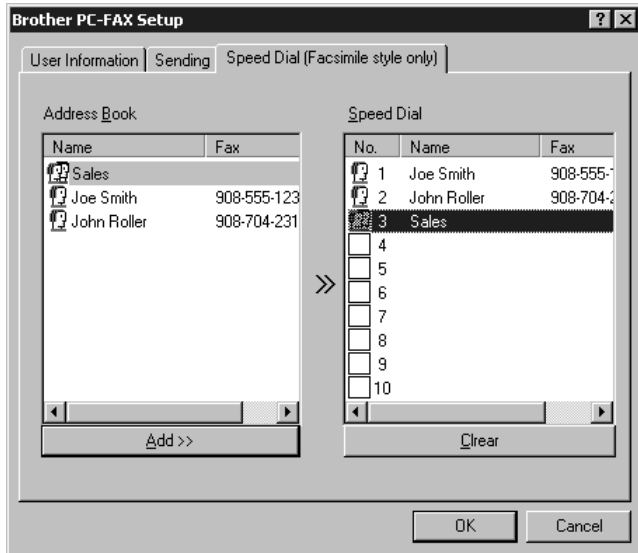

You can register any address or group on one of the ten Speed Dial buttons.

To register an address on a Speed Dial location:

- 1 Click the Speed Dial location you want to program.
- 2 Click the address or group you wish to assign to the Speed Dial location.
- 3 Click the **Add >>** button to program the Speed Dial location.

To clear a Speed Dial location:

- 1 Click the Speed Dial location you want to clear.
- 2 Click the **Clear** button.

The Address Book

From the **Start** menu, select **Programs, Brother, Brother MFL Pro Suite**, and then click **Address Book**.

The Brother Address Book dialog box will appear:

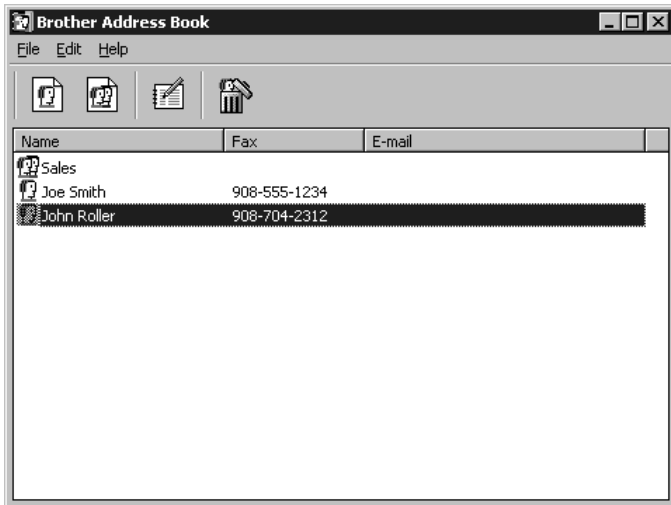

Setting Up a Member in the Address Book

In the Brother Address Book dialog box you can add, edit and delete stored information for members and groups.

- 1 In the Address Book dialog box, click the  icon to add a member.

The Brother Address Book Member Setup dialog box will appear:

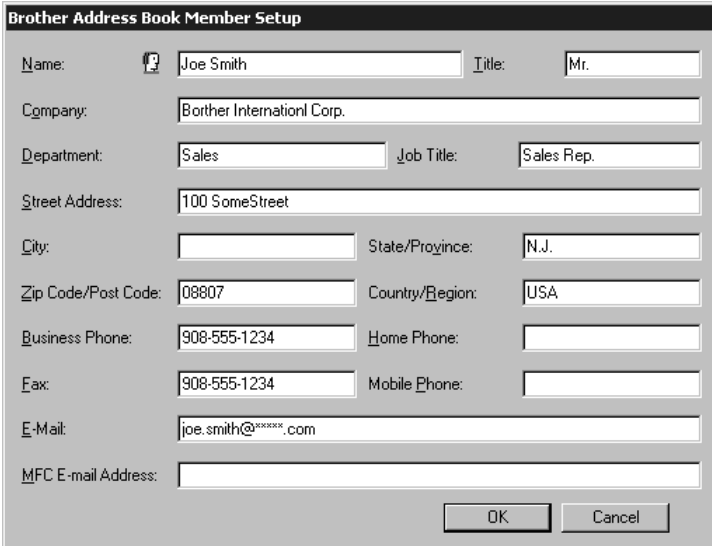

Brother Address Book Member Setup

Name: Title:

Company:

Department: Job Title:

Street Address:

City: State/Province:

Zip Code/Post Code: Country/Region:

Business Phone: Home Phone:

Fax: Mobile Phone:

E-Mail:

MFC E-mail Address:

If you use the optional NC-8100h network board, see Chapter 14 in NC-8100h User's Guide.

- 2 In the Brother Address Book Member Setup dialog box, type the member's information. **Name** and **Fax** are required fields. Click the **OK** button to save the member's information.

Setting Up a Group for Broadcasting

If you repeatedly send the same PC-FAX to multiple recipients, you can combine members into a Group.

- 1 In the Brother Address Book dialog box, click the  icon to create a group. The Brother Address Book Group Setup dialog box appears:

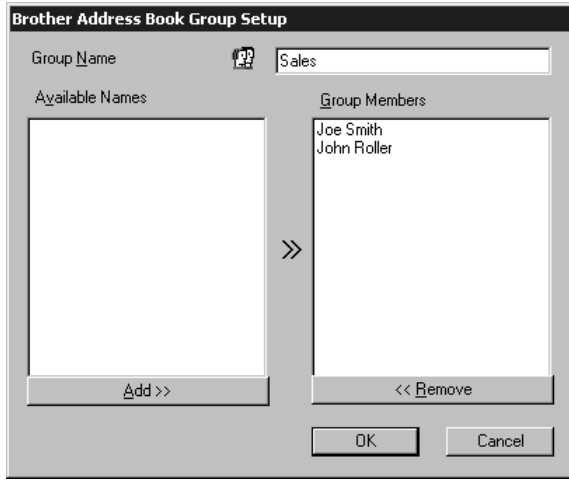

- 2 Type the name of the new group in the **Group Name** field.
- 3 In the Available Names box, select each member to be included in the Group, and then click **Add >>**. Members you add to the group will be listed in the Group Members box.
- 4 After all the members have been added, click **OK**.

Editing Member Information

To edit a Member or Group:

- 1 Select the Member or Group you want to edit .
- 2 Click the edit  icon.
- 3 Edit the Member or Group information.
- 4 Click **OK** to save your changes.

Deleting a Member or Group

To delete a Member or Group:

- 1 Select the Member or Group you want to delete.
- 2 Click the delete  icon.
- 3 Click OK when the Delete OK? Dialog appears.

Exporting the Address Book

You can export the address book to an ASCII text file (*.csv).

To export the current telephone book:



If you are creating a Vcard, you must first select the member.

- 1 From the Address Book select **File**, point to **Export**, and then click **Text**—**OR**—Click **Vcard** and go to Step 5.
- 2 Select the data fields you wish to Export from the **Available Items** column, and then click **Add >>**.



Select items in the order you want them listed.

- 3 If you are exporting to an ASCII file, select **Divide Character - Tab** or **Comma**. This selection inserts a Tab or Comma between each data field when it is Exported.
- 4 Select the **OK** button to save the data.

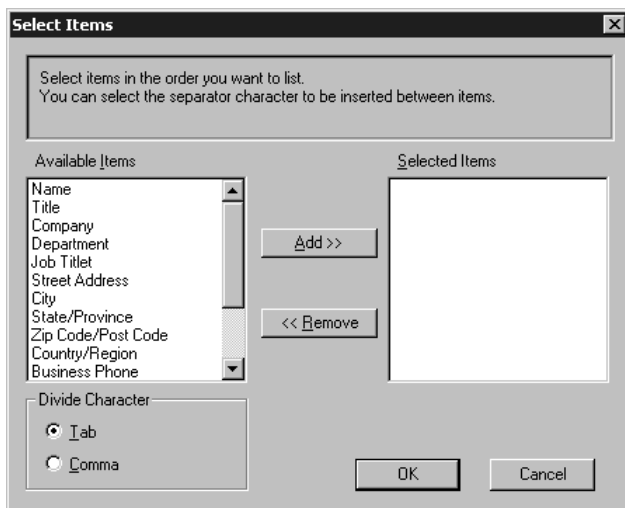

- 5 Type the name of the file, and then select **Save**.

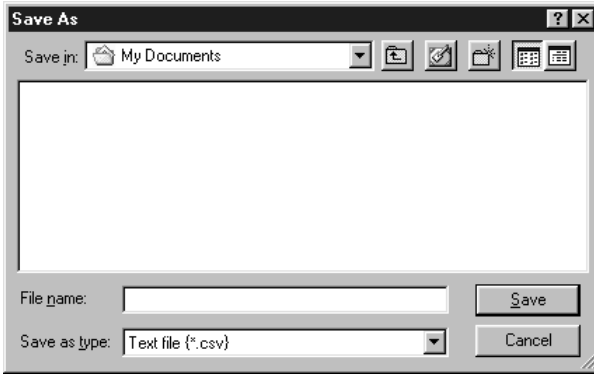

Importing to the Address Book

You can import ASCII text files (*.csv) or Vcards into your Address Book.

To import an ASCII text file:

- 1 From the Address Book select **File**, point to **Import**, and then click **Text**—**OR**—Click **Vcard** and go to Step 5.

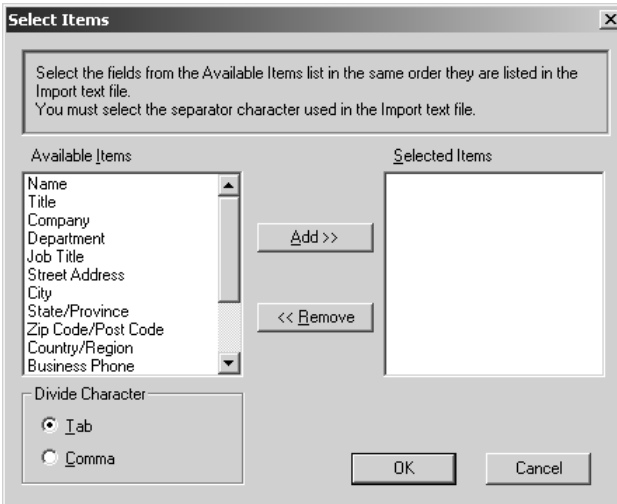

- 2 Select the data fields you wish to Import from the **Available Items** column, and then click **Add >>**.

Note Select the fields from the Available Items list in the same order they are listed in the Import text file.

- 3 Select **Divide Character - Tab** or **Comma** based on what file format you are importing.
- 4 Select the **OK** button to import the data.

- 5 Type the name of the file, and then select **Open**.

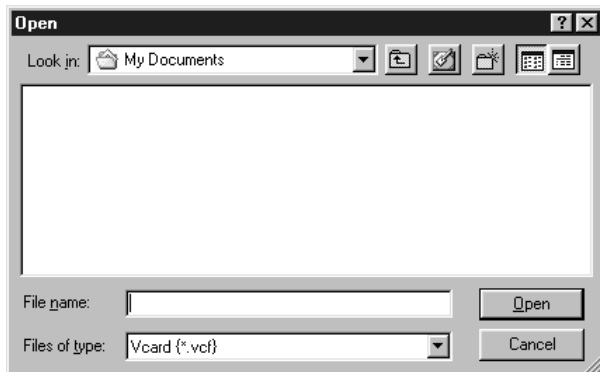

Setting Up Cover Page

Access the Brother PC-FAX Cover Page Setting from the FAX Sending dialog box by clicking . The Brother PC-FAX Cover Page Setup dialog box will appear:

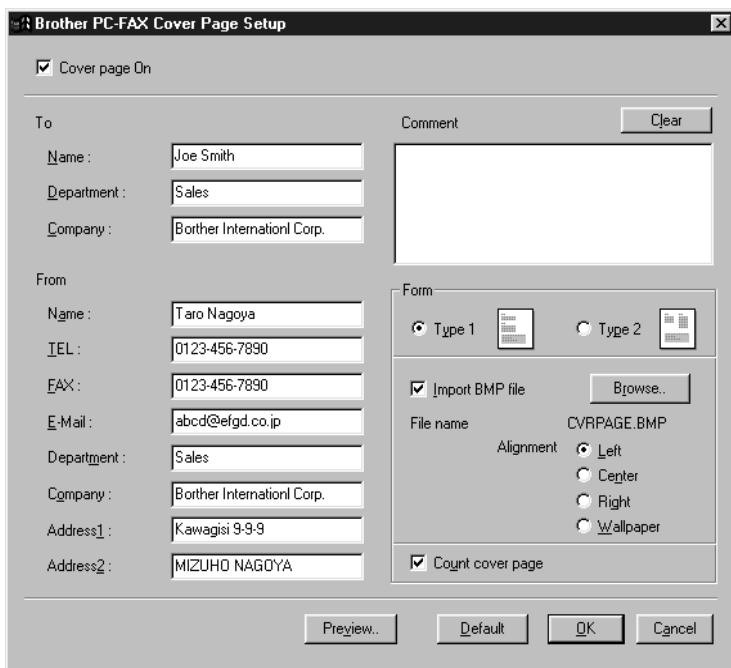

To

You can enter information in each box.



If you are sending a fax to multiple recipients, the recipient information will not be printed on the Cover Page.

From

You can enter information in each box.

Comment

Type the comment you want to add to the cover page.

Select Cover Page Form

Select the cover page form you want.

Import BMP file

You can insert a bitmap file, such as your company logo, in the cover page.

Select the BMP file by using the browse button, and then select the alignment style.

Count Cover Page

When this box is checked, the Cover Page will be included in the page numbering. When this box is not checked, the Cover Page will not be included.

Sending a File as a PC-FAX Using the Simple Style

- 1 Create a file in Word, Excel, Paint, Draw, or any other application on your PC.
- 2 From the **File** menu, select **Print**.

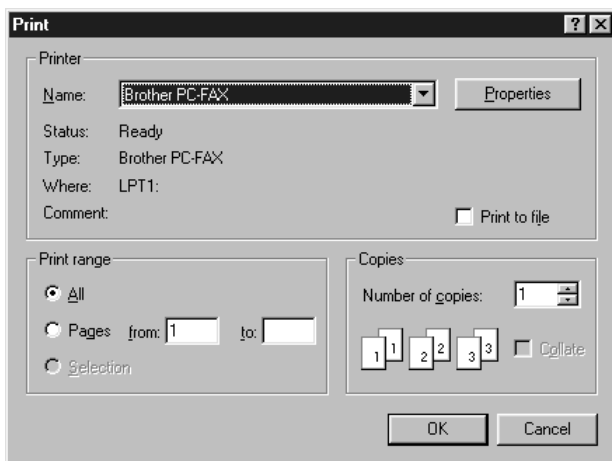

The Print dialog box will appear:

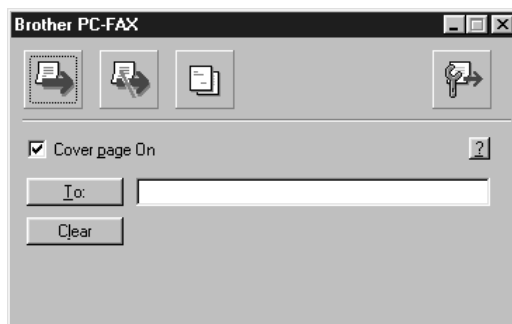

- 3 Select **Brother PC-FAX** as your printer, and then click **OK**.

The FAX Sending dialog box will appear:



- 4 In the **To:** field, type the fax number of the receiving party. You can also use the Address Book to select destination fax numbers. If you made a mistake entering a number, click the **Clear** button to clear all entries.
- 5 To send a Cover Page and note, click the **Cover Page** check box.
- 6 When you are ready to send your fax, click the Send  icon.
- 7 If you wish to cancel the fax, click the  icon.

Sending a File as a PC-FAX Using the Facsimile Style

- 1 Create a file in Word, Excel, Paint, Draw, or any other application on your PC.
- 2 From the **File** menu, select **Print**.
The Print dialog box will appear:

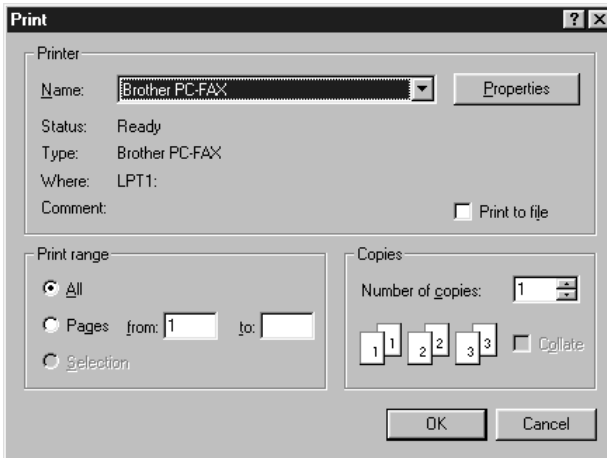

- 3 Select **Brother PC-FAX** as your printer, and then click **OK**.
The FAX Sending dialog box will appear:



- 4 Enter the fax number using any of the following methods:
 - a. Enter the number using the dial pad.
 - b. Click any of the 10 **Speed Dial** buttons.
 - c. Click the **Address Book** button, and then select a Member or Group from the Address Book.



If you make a mistake you can use the click the **Clear** button to clear all the entries.

- 5 To include a cover page, check the **Cover Page** option. You can also click the **Cover Page** button  to create or edit an existing cover page.

- 6 Click **Start** to send the fax.



If you wish to cancel the fax, click **Stop**.



Redial

If you want to redial a number, click **Redial** button to scroll through the last five fax numbers, and then click **Start**.

Setting Up PC-FAX Receiving (For Windows® Only)

You can set up your PC to receive incoming faxes into your PC.

Setting Up Your MFC

- 1 Press **Menu, 2, 1, 8**.
- 2 Press  or  to select **ON** (or **OFF**), and then press **Set**.
- 3 Press **Stop/Exit**.

Running PC-FAX Receiving

Form the **Start** menu, select **Program File, Brother, Brother MFL Pro Suite** and then select “PC-FAX Receiving”.

The PC FAX  icon will appear on your PC Task tray for this Windows® session.

Setting Up Your PC

- 1 Right-click the PC-FAX  10:40 icon on your PC Task Bar, and then click **PC-Fax RX Setup**.
- 2 The PC-Fax RX Setup dialog box will appear:



- 3 In **Ring Delay**, select the number of rings before your PC answers incoming calls.
- 4 In **Save file to**, use the Browse button if you want to change the path where PC-FAX files will be saved.
- 5 Make sure **File Format** is checked for *.max (Default Required to use with PaperPort)*.
- 6 If you want to, you can check the **Play wave file when receiving FAX** check box, and then enter the path.
- 7 To load PC FAX receiving *automatically* when you startup Windows®, select the **Add to Startup folder** check box.

Viewing New PC FAX Messages

Each time you start to receive a PC FAX, the Blue and Red  icons will blink on the PC Task Bar. The Red icon will remain.

- 1 Run PaperPort.
- 2 Open the Fax Received folder.
- 3 Double-click any of the new faxes to open and view them.



The title example of your unread PC message.
“Fax 2-20-2002 16:40:21 max”

18 Using Automatic E-Mail Printing

For Windows® 95, 98, 98SE, Me Only

Main Features

- You can use Automatic E-Mail Printing with other E-mail software: Brother Automatic E-Mail Printing has some extra functions that other E-mail software, such as Netscape Navigator™ or MS Internet Mail, do not support.
- Automatic E-Mail Printing can be configured for a multiple user account: In Brother Automatic E-Mail Printing you can set up more than one e-mail account on a single PC so you can print e-mail in each account automatically.
- Automatic access to your specified POP3 server at the specified time: You can specify the time when the Brother Automatic E-Mail Printing automatically accesses the server to check for new mail.
- Provides an “In Memory” printer driver: You can receive and print e-mail data at the same time, by searching for a specified character string in the mail header. It allows you to see the sender, subject and relevant part of the mail content.

Before You Use this Software

Please read *Using Automatic E-Mail Printing* in the **On-Line Documentation** on the CD-ROM. Check the online README.WRI file in the root directory of the CD-ROM for last-minute important information and troubleshooting tips not included in the On-Line Documentation.

To Access the On-Line Documentation



After you have installed the Brother driver(s) for your model and operating system, click **View On-Line Documentation** for operating instructions.

To Install Automatic E-mail Printing (Optional Application):

- 1 Insert MFL Pro CD-ROM into your CD-ROM drive.
- 2 Click on **Install Software** from the main CD-ROM screen.
- 3 Click **Automatic E-mail Printing**.



This is optional software and will not be required for printing, faxing and scanning operations.

The “Automatic E-mail Print” option is NOT available for Windows NT® 4.0 and Windows® 2000 Professional.

19 Using the Brother MFC with a New Power Macintosh® G3, G4 or iMac™/iBook

Set up Your USB Equipped Apple® Macintosh® G3, G4, iMac™ or iBook with Mac OS 8.5/8.51/8.6/9.0/9.0.4/9.1

Note Before you can connect the MFC to your Macintosh®, you must purchase a USB cable that is no longer than 6 feet (1.8 meters).

To work with your MFC your USB Equipped Apple® Macintosh® must be set up with Mac OS 8.5/8.51/8.6/9.0/9.0.4/9.1 (The Brother Scanner Driver works only with Mac OS 8.6/9.0/9.0.4/9.1)

Using BrotherShare Printer Driver with Your Apple® Macintosh®

To select the Printer:

- 1 From the Apple menu, open the **Chooser**.

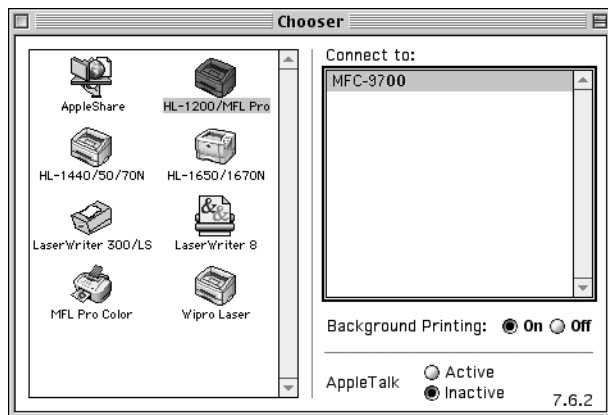

- 2 Click HL-1200/MFL Pro icon. On the right side of the Chooser, click the printer to which you want to print. Close the Chooser.

To print the document:

- From your Macintosh scanning application software such as Simple Text, click *File menu* and select *Page Setup*. You can change the settings for **Paper Size**, **Orientation** and **Scaling**, and then click **OK**.

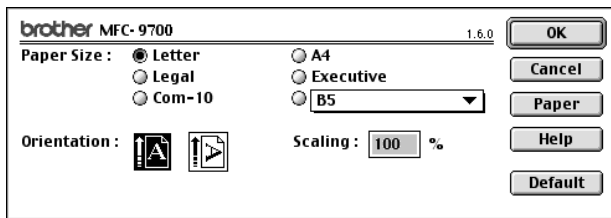

- From your Macintosh scanning application software such as Simple Text, click *File menu* and select *Print*. Click **Print** to start printing.

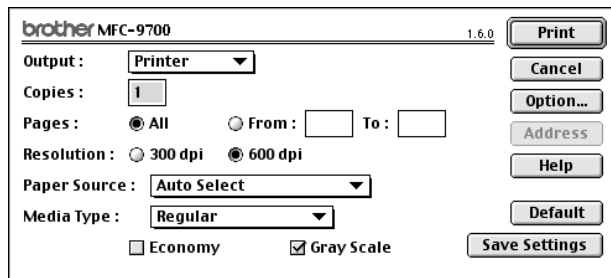

Note If you want to change **Copies**, **Pages**, **Resolution**, **Paper Source** and **Media Type**, select your settings before clicking **Print**.

Option Setup allows you to select **Duplex**.

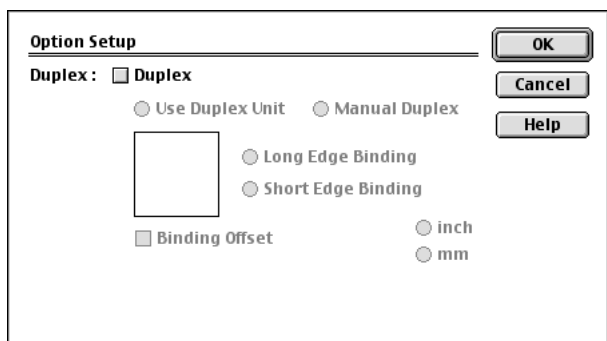

Sending a Fax from Your Macintosh® Application

You can send a fax directly from your Macintosh® application using the following steps:

- 1 Create a document in a Macintosh application.
- 2 To begin the fax transmission, select **Print** from the **File** menu. The Printer dialog box appears:

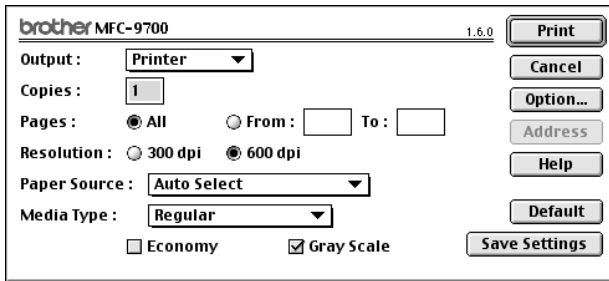

When **Printer** is selected, the top button shows **Print** and the **Address** button is grayed.

- 3 From the **Output** pop-up menu, select **Facsimile**.

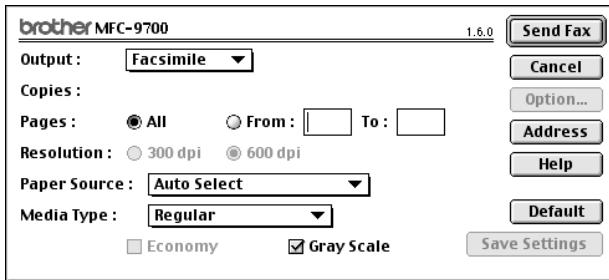

When **Facsimile** is selected, the top button shows **Send Fax** and the **Address** button is available.

4 Click **Send Fax**.

The *Send Fax* dialog box appears:

Send Fax									
Input Fax Number:	<input type="text"/>								
Stored Fax Numbers:	<table border="1"><tbody><tr><td>Barble</td><td>908-477-8888</td></tr><tr><td>Bob</td><td>908-869-8888</td></tr><tr><td>Frank</td><td>908-236-8888</td></tr><tr><td>Tony</td><td>908-569-8888</td></tr></tbody></table>	Barble	908-477-8888	Bob	908-869-8888	Frank	908-236-8888	Tony	908-569-8888
Barble	908-477-8888								
Bob	908-869-8888								
Frank	908-236-8888								
Tony	908-569-8888								
Destination Fax Numbers:									
<input type="button" value="New"/> <input type="button" value="Group"/> <input type="button" value="Edit"/> <input type="button" value="Delete"/> <input type="button" value="Save"/> <input type="button" value="Cancel"/> <input type="button" value="Send Fax"/>									

The *Send Fax* dialog box has two list boxes. The left box shows all the previously **Stored Fax Numbers**; the right box will show the **Destination Fax Numbers** as you select them.

5 To address the fax, type a fax number in the **Input Fax Number** box.

—OR—

Select a name/number from the **Stored Fax Numbers** box, and then click . Your recipient will appear in the **Destination Fax Numbers** box.



You can select several stored numbers at once by using the Shift and Ctrl keys.

6 If you want to, you can add your new recipients to the Stored Fax Number at this time by clicking **New**. (See *Adding a New Member*, page 19-5.)

—OR—

You can add a new group by clicking **Group**. (See *Adding a New Group*, page 19-6.)

7 If you are finished addressing your fax, click **Send Fax**.



To select and send only certain pages of the document, enter the page numbers in the From and To : boxes in the Facsimile dialog box.



If you click Send Fax without addressing your fax, the following error message appears:

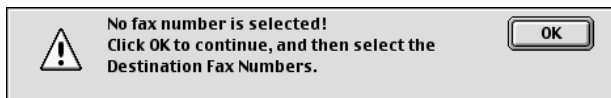

Click **OK** to return to the Send Fax dialog box.

Setting Up Your Address Book

You can add new members and groups to your Address Book, even while you are addressing a fax.

Adding a New Member

- 1 To add a new member to the Address Book, in the Facsimile dialog box click **Address**.

The Address Book dialog box appears:

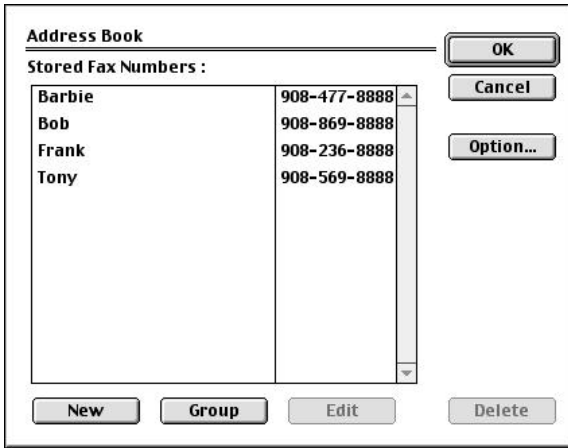

- 2 Click **New**. The following dialog box appears:

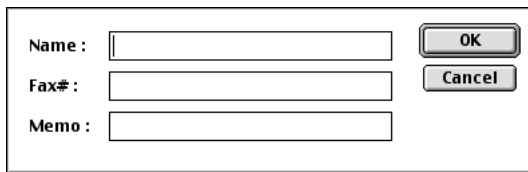

Name :

Fax# :

Memo :

OK

Cancel

- 3 Type the name and fax number.
- 4 If you want to, you can store a comment in the Memo field if you wish (up to 15 characters).
- 5 Click **OK** to return to the Address Book dialog box.

Adding a New Group

You can set up a group of multiple recipients.

1 Click **Group**.

The Group Setting dialog box appears.

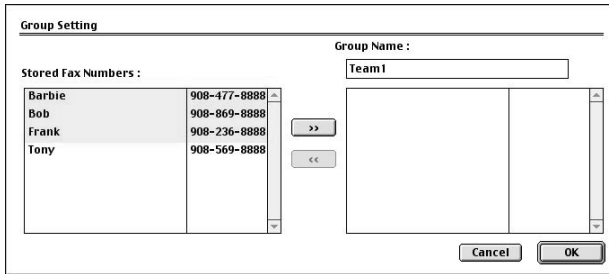

2 In the Group Name field, type a name for your Group.

3 From the **Stored Fax Numbers** box select the recipients for your Group, and then click **>>**.

Your selection will appear in the box under the **Group Name** field.

4 Click **OK**.

The Address Book dialog box reappears:

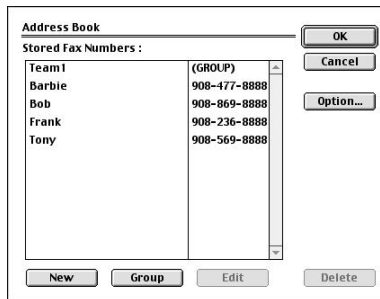

5 Click **OK**.

The Print/Facsimile dialog box reappears:

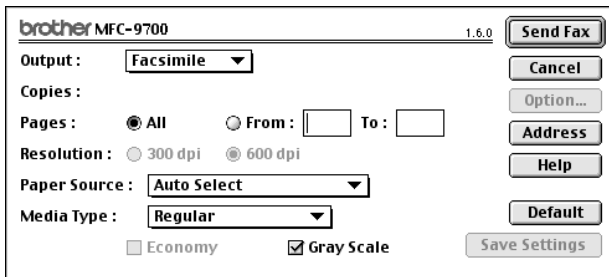

6 If you are ready to send your fax, click **Send Fax**.
(Follow the steps on page 19-3 for sending a fax.)

Using Brother TWAIN Scanner Driver with Your Apple® Macintosh®

The Brother MFC software includes a TWAIN Scanner driver for Macintosh®. This Macintosh® TWAIN Scanner driver can be used with application that supports the TWAIN specification. You can use PaperPort® for scanning.

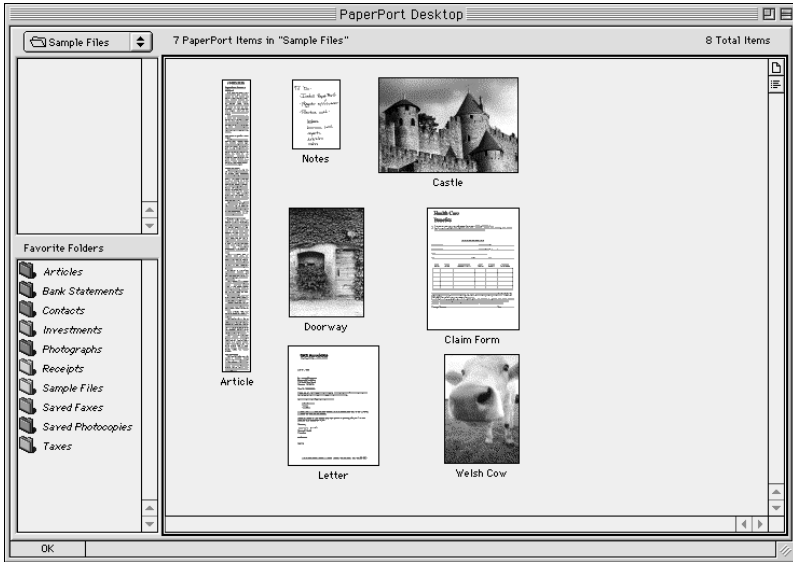

Accessing the Scanner

Run your PaperPort® software. You will see the **PaperPort® icon** in the upper right corner of your screen. The first time you use the Brother TWAIN driver, set it as the default by choosing the *Select Source*, and then click the *PaperPort®* icon. Afterward, for each original you scan, choose *Acquire Image* by clicking the *PaperPort®* icon. The Scanner setup dialog box will appear.

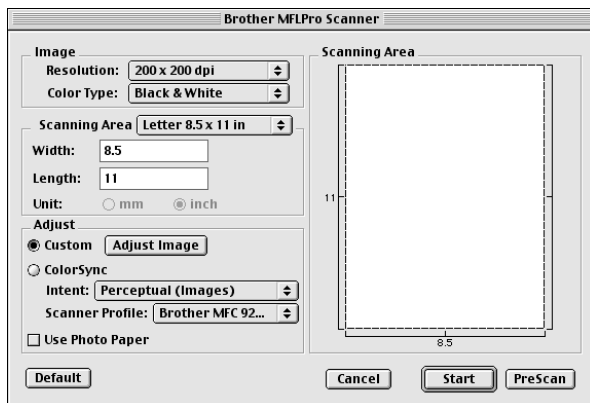

Scanning a Document into Your Macintosh G3, G4 or iMac

- 1 Place the original in the ADF.
- 2 Adjust the following settings, if needed, in the scanner setup dialog box:
 - Resolution*
 - Color Type*
 - Brightness*
 - Contrast*
 - Scanning Area*

- 3 Click **Start**.

When scanning is finished, the image will appear in your graphics application.

Settings in the Scanner Window

Image

Resolution

Choose the scanning resolution from the Resolution pop-up menu. Higher resolutions take more memory and transfer time, but can achieve a finer scanned image. (Each model has different resolutions. See Specification.)

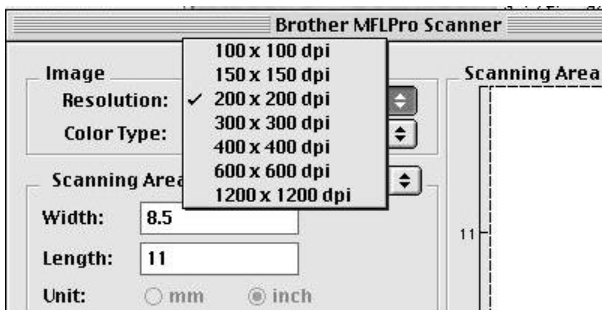

Scanning Area

Set the **Size** to one of the following:

- *Letter* (8.5 × 11 inches)
- *A4* (210 × 297 mm)
- *Legal* (8.5 × 14 inches)
- *A5* (148 × 210 mm)
- *B5* (182 × 257 mm)
- *Executive* (7.25 × 10.5 inches)
- *Business Card* (90 × 60 mm)
- *Custom* (User adjustable from 0.35 × 0.35 inches to 8.5 × 14 inches)

After you choose a custom size, you can adjust the scanning area. Click and hold the mouse button as you drag the mouse to crop the image.

Width: Enter the width of the custom size.

Length: Enter the length of the custom size.

Business Card Size

To scan business cards, select the Business Card size setting (90 × 60 mm) and place the business card at the top center of a carrier sheet.



Carrier sheets are available from your Dealer.

When scanning photographs or other images for use in a word processor or other graphics application, it is a good idea to try different settings for the contrast, mode and resolution to determine which settings look best.

Miscellaneous

Brightness

Adjust the brightness settings to obtain the best image. The Brother TWAIN Scanner driver offers 100 brightness settings (-50 to 50). The default value is 0, representing an “average” setting.

You can set the brightness level by dragging the slider to the right to lighten the image or to the left to darken the image. You can also type a value in the box to set the setting. Click **OK**.

If the scanned image is too light, set a lower brightness value and scan the document again.

If the image is too dark, set a higher brightness value and scan the document again.

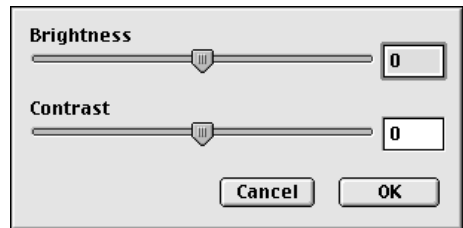

Contrast

The contrast setting is adjustable only when you have selected one of the gray scale settings, but it is not available when Black & White is selected as the Gray Scale.

Increasing the contrast level (by dragging the slider to the right) emphasizes dark and light areas of the Image, while decreasing the contrast level (by dragging the slider to the left) reveals more detail in gray areas. Instead of using the slider, you can type a value in the box to set the contrast. Click **OK**.

PreScanning an Image

PreScanning allows you to scan an image quickly at a low resolution. A thumbnail version will appear in the Scanning Area. This is only a preview of the image, so you can see how it will look. The PreScan button is used to preview an image for cropping any unwanted portions from the image. When you are satisfied with the preview, click Start to scan the image.

1 Insert the original face up in the ADF.

2 Click **PreScan**.

The entire original will be scanned into your Macintosh G3 or iMac and will appear in the Scanning Area of the Scanner dialog box:

3 To scan a portion of the prescanned image, click and drag the mouse to crop it.

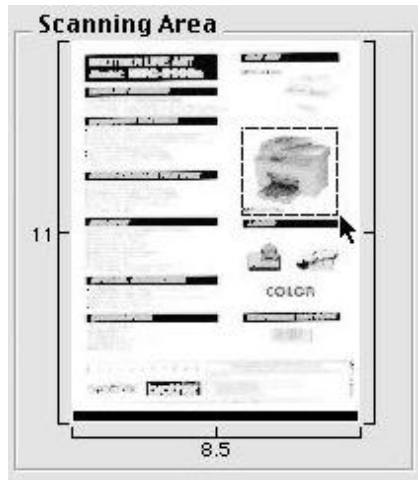

4 Insert original in the ADF of the Brother MFC again.

5 Adjust the settings for Resolution, Color Type (Gray Scale), Brightness, Contrast, and Size in the Scanner Setup dialog box, as needed.

6 Click **Start**.

This time only the selected area of the original will appear in the Scanning Area.

7 Use your application software for editing and refining the image as usual.

20 Optional Accessories

Paper Cassette #2 (Option)

You can purchase the Paper Cassette #2 accessory (**LT400**) to use as a third paper source. Cassette #2 holds up to 250 sheets of 20 lb. (75 g/m²) paper.

Paper Cassette #2:	Holds approx. 250 sheets of 20 lb. (75 g/m ²) Letter/A4 paper
Basis Weight:	16 to 28 lb. (60 to 105 g/m ²)
Caliper:	0.003 to 0.005 inches. (0.08 to 0.13 mm)
Moisture Content:	4% to 6% by weight
Smoothness:	100 to 250 (Sheffield)
We Recommend: Cut sheet:	Xerox 4200DP 20 lb, Champion Paper One 20 lb, Hammermill Laser Paper 24 lb

Network (LAN) Board (Option)

When you add the Optional Network (LAN) Board (NC-8100h), you can connect your MFC into the network to use the Internet FAX, Network Scanner, Network Printer and Network Management operations.

21 Troubleshooting and Routine Maintenance

Troubleshooting

IMPORTANT

For technical and operational assistance, you must call the country where you purchased the printer. Calls must be made *from within* that country.

Error Messages

As with any sophisticated office product, errors may sometimes occur. If this happens, your MFC often identifies the problem and displays an error message. The table below explains the most common error messages.

You can correct most problems by yourself. If you need additional help, call the Brother fax-back system.

In USA:

1-800-521-2846

Error Messages		
Error Message	Cause	Action
CHANGE DRUM SOON	The drum unit is near the end of its life.	Use the drum unit until you have a print quality problem; then replace the drum unit with a new one.
	The drum counter was not reset.	1. Open the front cover, and then press Stop/Exit . 2. Press 1 to reset.
CHECK PAPER CHECK PAPER #1 CHECK PAPER #2	The MFC is out of paper or paper is not properly loaded in the paper cassette.	Refill the cassette or remove the paper and load it again.
CHECK PAPER SIZE	When you see this error, the paper in the cassette does not match the paper size you set in Menu, 1, 1 .	Either load the appropriate size paper or change the default setting. (See page 4-1).
CHECK SCAN LOCK	The scanner lock is locked.	Release the scanner lock lever, and then press Stop/Exit .
COMM. ERROR	Poor phone line quality caused communication error.	Try the call again. If problem continues, call Telephone Company to check your phone line.
CONNECTION FAIL	You tried to poll a MFC that is not in Polled Waiting mode.	Verify the other party's polling setup.

Error Messages		
Error Message	Cause	Action
COOLING DOWN WAIT FOR A WHILE	The temperature of the drum unit or toner cartridge is too hot. The MFC will pause its current print job and go into cooling down mode. During the cooling down mode, you will hear the cooling fan running while the display on the MFC shows COOLING DOWN , and WAIT FOR A WHILE .	You must wait 20 minutes for it to cool.
COVER OPEN PLS CLOSE COVER	The front cover was not completely closed.	Close the front cover for the drum unit.
DISCONNECTED	The other party or other party's fax machine terminated the call.	Try to transmit or receive again.
CHECK ORIGINAL	Originals were not inserted or fed properly, or original scanned from ADF was longer than about 40 inches (90cm).	See <i>Original Jams and Paper Jams</i> , page 21-3.
MACHINE ERROR XX	MFC has a mechanical problem.	Call Brother Customer Service. In USA: 1-800-284-4329 In Canada: 1-877-BROTHER In Montreal: 1-514-685-6464
OUT OF MEMORY (May occur when the MFC is used as a printer)	You can't store data in the memory.	See page 11-2.
NO RESPONSE/ BUSY	The number you dialed does not answer or is busy.	Verify the number and try again.
NOT REGISTERED	You tried to access a One Touch or Speed Dial number that is not programmed.	Set up the One Touch or Speed Dial number. (See pages 7-1, 7-2.)
PLS OPEN COVER	A page, piece of paper or paper clip, etc. may be jammed inside the MFC.	Open the front cover. If you see any jammed paper or other item, gently pull it out, then close the front cover. If the error message remains, open and close the front cover again. If the MFC cannot reset itself and return to the date and time prompt, it will display MACHINE ERROR XX . Please call Brother Customer Service and tell them the MFC Error number at: In USA: 1-800-284-4329 In Canada: 1-877-BROTHER In Montreal: 1-514-685-6464
PAPER JAM	The paper is jammed in the MFC.	See page 21-4.

Error Messages		
Error Message	Cause	Action
TONER EMPTY	Toner cartridge is not installed. —OR— Toner is used up and printing is not possible.	Reinstall the toner cartridge. —OR— Replace the toner cartridge with a new one. (See page 21-19.)
TONER LOW	If the LCD shows TONER LOW, you can still print. But the toner is depleted and the MFC is telling you that the toner will soon run out.	Order a new toner cartridge now.

Original Jams and Paper Jams

Based upon where the original or printed sheet is jammed, follow the appropriate set of instructions to remove it.

Original is Jammed in the top of the ADF Unit

- 1 Remove any paper from the ADF that is not jammed.
- 2 Lift the ADF cover.
- 3 Pull the jammed original out to the left.
- 4 Close the ADF cover.
- 5 Press **Stop/Exit**.

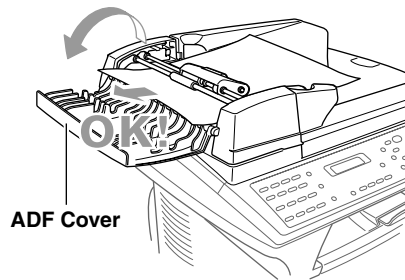

Original is Jammed inside the ADF Unit

- 1 Lift the document cover.
- 2 Remove any paper from the ADF that is not jammed.
- 3 Lift the ADF unit.
- 4 Pull the jammed original out to the right.
- 5 Close the ADF unit.
- 6 Press **Stop/Exit**.

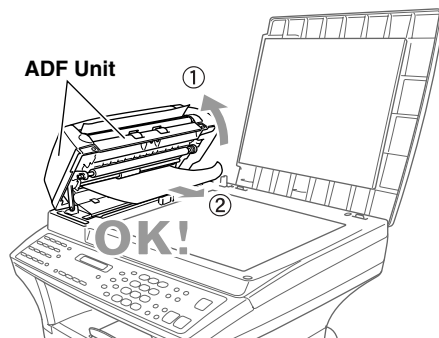

Paper Jam

Before you can clear a paper jam error, you must find out where the paper is stuck. See the following three types of paper jams.

WARNING

Do not use force to pull the jammed paper from the paper tray because you may damage the MFC and cause toner to scatter on the next printed pages.

After you use the MFC, some internal parts are extremely **HOT!** When you open the front, never touch the shaded parts shown in the following diagram.

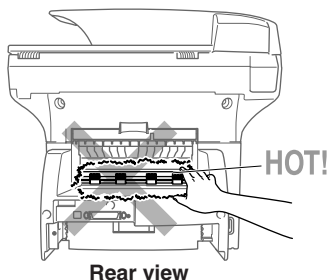
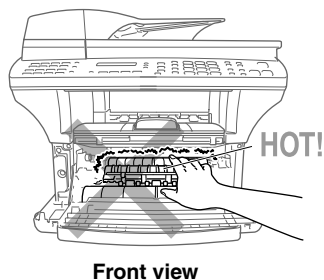

Paper is Jammed in the Paper Cassette

- 1 Pull the paper cassette out of the MFC.
- 2 Remove any crinkled sheets.

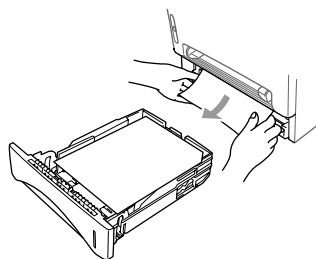

- 3 Adjust the guides to fit.
- 4 Press down the paper to flatten it in the paper cassette.
- 5 Reinstall the paper cassette.

Paper is Jammed near the Drum Unit

- 1 Open the front cover.
- 2 Remove the drum unit but do not force it if it cannot be removed easily. Instead, pull the edge of the jammed paper from the paper cassette.

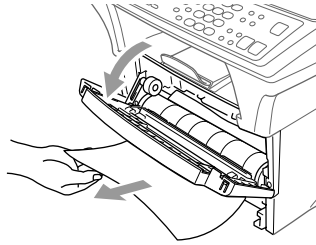
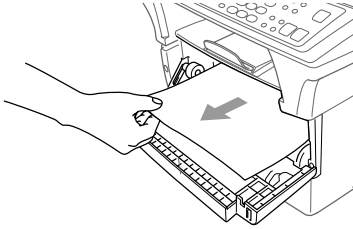

- 3 Gently pull out the jammed paper.
- 4 Reinstall the drum unit.
- 5 Close the front cover.

Paper is Jammed in the Fuser Unit

- 1 Open the rear cover.
- 2 Pull out jammed paper. When you have to pull paper out the back of the MFC, the fuser may get dirty with toner powder causing the next few printed page(s) to look messy. Print a few copies of the test page until the pages print clearly.
- 3 Close the rear cover.

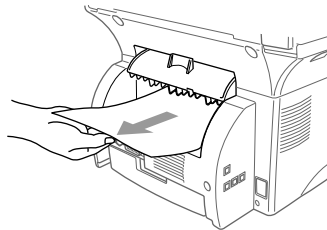

If You Are Having Difficulty with Your MFC

If you think there is a problem with your MFC, *make a copy first*. If the copy looks good, the problem is probably not your MFC. Check the chart below and follow the troubleshooting tips.





DIFFICULTY	SUGGESTIONS
Printing or Receiving Faxes	
Condensed Print and Horizontal Streaks / Top and Bottom of Sentences Are Cut Off	If your copy looks good, you probably had a bad connection, with static or interference on the phone line. If the copy looks bad, call Brother Customer Service at 1-800-284-4329 (In USA), 1-877-BROTHER (In Canada) or 1-514-685-6464 (In Montreal).
Vertical Black Lines When Receiving	Sometimes you may see vertical streaks/black lines on the faxes you receive. Either your MFC's primary corona wire for printing may be dirty, or the sending party's fax scanner may be dirty. Clean your primary corona wire (see page 21-18), or ask the sender to make a copy to see if the problem is with the sending machine. Try receiving from another fax machine. If the problem continues, call Brother Customer Service at 1-800-284-4329 (In USA), 1-877-BROTHER (In Canada) or 1-514-685-6464 (In Montreal).
Fax Machine "Hears" Voice as CNG Tone	If your fax machine is set to Easy Receive ON, it is more sensitive to sounds. Your fax machine may mistakenly interpret certain voices or music on the line as a calling fax machine and respond with fax receiving tones. Deactivate the fax by pressing #51 if you are at an extension phone or press Stop if you are at the fax machine or an external phone. Try avoiding this problem by turning Easy Receive to OFF. (See <i>Easy Receive</i> , page 5-3.)
Horizontal streaks; lines are missing.	You may get a fax with horizontal streaks or with missing lines. Usually this is caused by a poor telephone connection. Ask the other party to send the fax again.
Received faxes appear as split or blank pages.	If the received data is divided and printed on two pages or if you get an additional blank page, your Paper Size setting may not be correct for the paper you are using (see pages 4-1). If you are using the fixed reduction feature, check to see if the reduction ratio is suitable for the real paper. (See page 11-4).
Phone Line or Connections	
MFC Does Not Answer When Called	Make sure the MFC is not in MANUAL mode. Check for dial tone. If possible, call your MFC to hear it answer. If there is still no answer, check the telephone line cord connection. If there is no ringing when you call your MFC, call your Telephone Company to check the line.
Sending Faxes	
Poor Transmitting Quality	Try changing your resolution to FINE or S.FINE. Make a copy to verify your MFC's scanner operation.



DIFFICULTY	SUGGESTIONS
Transmission Verification Report says "Result:NG"	There is probably temporary noise or static on the line. Try sending the fax again. If the problem continues, call the Telephone Company to check your phone line.
Vertical Black Lines When Sending	If the copy you made shows the same problem, your scanner is dirty. (See <i>Cleaning the Scanner</i> , page 21-16.)
Handling Incoming Calls	
Transferring a Fax Call to the MFC	If you answered at an extension phone, press your Fax Receive Code (default setting is ✕51). When your MFC answers, hang up.
I have difficulty with custom features on a single line	<p>If you have Call Waiting, Call Waiting/Caller ID, RingMaster, Voice Mail, an answering machine, an alarm system or other custom feature on a single phone line with your MFC, it may create a problem sending or receiving fax data.</p> <p>For Example: Your Brother machine handles the Caller ID subscriber services. However, if you subscribe to Call Waiting or some other custom service and its signal comes through the line while your machine is sending or receiving a fax, the signal can temporarily interrupt or disrupt the fax data. Brother's ECM feature should help overcome this problem. This condition is related to the telephone system industry and is common to all devices that send and receive information on a single, shared line with custom features. If avoiding a slight interruption is crucial to your business, a separate line with no custom features is recommended.</p>
Copy Quality Difficulties	
Vertical streaks appear in copies.	Sometimes you may see vertical streaks on your copies. Either the scanner or the primary corona wire for printing is dirty. Clean them both. (See pages 21-16 and 21-18.)
General Printing Difficulties	
The MFC does not print.	<p>Check the following:</p> <ul style="list-style-type: none"> • The MFC is plugged in. (See page 2-8.) • The toner cartridge and drum unit are installed properly. (See page 2-4.) • The interface cable is securely connected between the MFC and computer. (See Quick Setup Guide.) • Check to see if LCD is showing an error message. (See page 21-1 to 21-3.)
The MFC prints unexpectedly or it prints garbage.	Reset the MFC or unplug the electrical cord and plug it back in. Check the primary settings in your application software to make sure it is set up to work with your MFC.

DIFFICULTY	SUGGESTIONS
The MFC cannot print full pages of a document.	The MFC received a very complex print job and could not process part of the page. This print. may be solved in several ways. If you are using Windows® 95/98/98SE/Me/2000 Professional or Windows NT® Workstation Version 4.0 with the supplied printer driver, see the “Windows® Setup Printing Difficulties” section. Try to reduce the complexity of your document or reduce print resolution.
The MFC prints first couple of pages correctly, then some pages have text missing.	Your computer is not recognizing the printer’s input buffer full signal. Please make sure to connect the printer cable correctly.
The MFC cannot print full pages of a document. OUT OF MEMORY message occurs.	Reduce the printer resolution. Reduce the complexity of your document and try again. Reduce the graphic quality or the number of font sizes within your application software.
My headers or footers appear when I view my document on the screen but do not up when I print them.	Most laser printers have a restricted area that will not accept print. Usually these are the first two lines and last two lines, leaves 62 printable lines. Adjust the top and bottom margins in your document to allow for this.
Scanning Difficulties	
TWAIN Errors appear while scanning.	Make sure the Brother TWAIN Driver is selected as the primary source. In PaperPort®, from the File menu select File, select Source, and then highlight the Brother TWAIN Driver and click Select.
Software Difficulties	
You see the “New Hardware Found” message on your PC screen (although you have already installed the drivers in Windows 95).	Click on ‘Do not install a driver. (Windows will not prompt you again)’ and click ‘OK’.
You see the “Update Device Driver Wizard” or “Add New Hardware Wizard” message on your PC screen (although you have already installed the drivers in Windows 95 or 98).	Follow the instructions from the installer, then click Next. Click Finish when it appears on the screen.

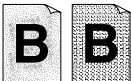
DIFFICULTY	SUGGESTIONS
<p>“Unable to write to LPT1” or “LPT1 already in use” Error Message appears.</p>	<p>1. Make sure the MFC is on (plugged into the AC outlet) and that it is connected directly to the computer using the bundled IEEE-1284 bi-directional parallel cable. The cable must not go through another peripheral device (such as a Zip Drive, External CD-ROM Drive, or Switch box).</p> <p>2. Make sure the MFC is not displaying an error message on the LCD Display.</p> <p>3. Make sure no other device drivers, which also communicate through the parallel port, are running automatically when you boot up the computer (such as, drivers for Zip Drives, External CD-ROM Drive, etc.) Suggested areas to check: (<i>Load=, Run=command lines in the win.ini file or the Statup Group</i>)</p> <p>4. Check with your computer manufacturer to confirm that the computer’s parallel port settings in the BIOS are set to support a bi-directional machine; i.e. (Parallel Port Mode – ECP)</p>
<p>“MFC is Busy” or “MFC Connect Failure” Error Message appears.</p>	
<p>“MFC Connect Failure”</p>	<p>If the MFC is not connected to your PC and you have loaded the Brother software, the PC will show “MFC Connect Failure” each time you restart Windows®. You can ignore this message or you can turn it off by deselecting the AutoLoad PopUp check box in the Brother Control Center. (See <i>How to Turn Off AutoLoad</i>, page 15-2 in On-Line Documentation on the CD-ROM.)</p>
<p>DOS Setup Printing Difficulties</p>	
<p>I cannot print from my application software.</p>	<p>Check that the DOS application software interface settings match those of your printer: for example, if you are using a parallel printer cable, you would probably set your DOS software printer port to LPT1. Check for an error message on the LCD.</p>
<p>The MFC prints, but it prints incorrect information. Sometimes it prints a couple of characters and then ejects the pages, etc.</p>	<p>This is an indication that your application printer emulation Prints setting and the MFC’s printer emulation do not match. Check your application software to make sure you selected the correct printer driver. The MFC emulates HP LaserJet IIP. Try setting the MFC to HP emulation in Remote Printer Console and then select the HP LaserJet IIP printer in your application software.</p>
<p>The MFC prints the part of my document but does not print the last page (The LCD shows REMAINED DATA).</p>	<p>This is common problem first with database software and part of spreadsheet software when they are not correctly set up. The data has been sent to the printer but the printer did not receive the Page Eject command. Press Reset to eject the page. Then ask your software supplier how to add a Page Eject (or Form Feed) command to the end of your print job.</p>
<p>How can I change the user settings or default settings on the MFC?</p>	<p>Use the Remote Printer Console (RPC) program.</p>

DIFFICULTY	SUGGESTIONS
Paper Handling Difficulties	
The MFC does not load paper. The LCD shows CHECK PAPER or PAPER JAM .	Check to see if the CHECK PAPER or PAPER JAM message appears on the LCD. If it is empty, load a new stack of paper into the paper cassette. If there is paper in the paper cassette, make sure it is straight. If the paper is curled, you should straighten it. Sometimes it is helpful to remove the paper, turn the stack over and put it back into the paper cassette. Reduce the amount of paper in the paper cassette, then try again. Check the manual feed mode is not selected in the printer driver.
The MFC does not feed paper from the manual feed slot.	Reinsert the paper firmly, load one sheet at a time. Make sure that manual feed mode is selected in the printer driver.
How can I load envelopes?	You can load envelopes from the manual feed slot. Your application software must be set up to print the envelope size you are using. This is usually done in the Page Setup or Document Setup menu of your software. Refer to your software application manual.
What paper can I use?	You can use plain paper, envelopes, transparencies and labels that are made for laser machines. (For information on paper you can use, see <i>Acceptable Paper, page 2-5</i> .)
How can I clear paper jams?	See <i>Paper Jam, page 21-4</i> .
Print Quality Difficulties	
Printed pages are curled.	Thin Paper (17lb-18.4lb) can cause this problem. Make sure you select the Paper Type that suits the paper in your multi-purpose sheet feeder. (See <i>Paper Type, page 11-8 and 11-9</i> and <i>Media Type, page 14-4</i> .)
Printed pages are smeared.	Rough surfaces or thick media can cause “smeared pages” — OR —“the toner to smear”. Make sure you select the correct Paper Type that suits the paper in your multi-purpose sheet feeder. (See <i>Paper Type, page 11-8 and 11-9</i> and <i>Media Type, page 14-4</i> .)
Printouts are too dark or light.	Adjust the print conditions in the Print Density setting. It has been factory set to the middle position. (See <i>Setting the Print Density, on page 5-4</i> .)
Printed pages contain white stripes.  White Stripes or Faint Images	You may fix this by wiping the scanner windows with a clean soft cloth. (See <i>Routine Maintenance and Cleaning the Drum Unit, on pages 21-16 and 21-18</i> .) If you still see white stripes or faint images and the LCD shows CHANGE DRUM SOON , replace the drum unit with a new one. Check the MFC’s environment. Conditions such as humidity, high temperatures, etc. may cause this print defect to occur.

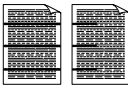
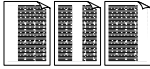
DIFFICULTY	SUGGESTIONS
<p>Printed pages are stained corona with toner or have vertical stripes.</p>  <p>Dark Stripes or Toner Stains</p>	<p>Clean the MFC's interior and the primary wire of the drum unit. (See <i>Routine Maintenance</i> and <i>Cleaning the Drum Unit</i>, on pages 21-16 and 21-18.) Make sure that the tab of the corona wire is at the Home (▼) position.</p> <p>If after cleaning, you still see dark stripes or toner stains and the LCD shows CHANGE DRUM SOON, replace the drum unit with a new one.</p>
<p>Printed pages have white spots in black text and graphic areas.</p>  <p>White Spots</p>	<p>Make sure that you use paper that meets the specifications. Rough surface or thick media can cause the problem. If you still see white spots and the LCD shows CHANGE DRUM SOON, replace the drum unit with a new one. Check the MFC's environment; conditions such as high humidity may cause this situation to occur.</p>
<p>Toner scatters and stains the printed page.</p>  <p>Scattering Toner</p>	<p>Adjust the print conditions in the Print Density setting. Remove the drum unit and clean the MFC's interior. (See <i>Routine Maintenance</i> and <i>Cleaning the Drum Unit</i>, on pages 21-16 and 21-18.) Make sure that you use paper that meets specifications. (See page 2-5.) If you still have scattered toner and the LCD shows CHANGE DRUM SOON, replace the drum unit with a new one. Check the MFC's environment; high temperature and high humidity may cause this condition to occur.</p>
<p>The whole page is printed black.</p>  <p>Black Page</p>	<p>Clean the MFC's interior and the primary corona wire of the drum unit. (See page 21-18.) Also, do not use heat sensitive paper as it will cause this problem. After cleaning, if the printed pages are still black or the LCD shows CHANGE DRUM SOON, replace the drum unit with a new one. The drum unit may be damaged.</p>

DIFFICULTY	SUGGESTIONS
Print Quality Difficulties (Cont.)	
<p>Nothing printed on the page.</p>  <p style="text-align: center;">White Page</p>	<p>Make sure that the toner cartridge is not empty. Wipe electric terminals referring to <i>Routine Maintenance</i> and <i>Cleaning the Drum Unit</i>, on pages 21-16 and 21-18. Make sure that a torn piece of paper does not remain on the scanner window.</p>
<p>Printed pages are marked at regular intervals.</p>  <p style="text-align: center;">Example of Regular Marking</p>	<p>Markings may disappear by themselves. Try copying multiple pages to clear this problem. Markings may occur if the MFC has not been used for a long time. A possible cause is that the surface of the drum is scratched. You must then replace the drum unit with a new one. If the markings do not disappear, it may be that the drum was marked or damaged by excessive exposure to light. In this case, replace the drum unit with a new one.</p>
<p>Printed pages are blurred at the center or at either edge.</p>  <p style="text-align: center;">Blurred Page</p>	<p>Certain environmental conditions such as humidity, high temperatures, etc. may cause this condition to occur. Make sure the MFC is placed on a flat, horizontal surface. Remove the drum unit with the toner cartridge installed. Try rocking them from side to side. You may clear a blurred page by wiping the scanner windows with a clean soft cloth. (See <i>Routine Maintenance</i> and <i>Cleaning the Drum Unit</i>, on pages 21-16 and 21-18.) If a blurred page occurs after cleaning and the LCD shows CHANGE DRUM SOON, replace the drum unit with a new one.</p>
<p>Ghost images appear on printed pages.</p>  <p style="text-align: center;">Ghost Images</p>	<p>Adjust the print conditions by changing the Print Density setting, page 5-4.—OR—Rough surfaces or thick media can cause a ghost image. Make sure you select the Paper Type that suits the paper in your multi-purpose sheet feeder. (See <i>Paper Type</i>, page 11-8 and 11-9 and <i>Media Type</i>, page 14-4.)</p>



The drum unit is a consumable item and it is necessary to replace it periodically.

Packing and Shipping the MFC

Whenever you transport the MFC, use the packing materials that came with your MFC. If you do not pack the MFC correctly, you could void your warranty.

- 1 Unplug the MFC from the telephone wall jack.
- 2 Unplug the MFC from the AC outlet.

! WARNING

Do not unplug the MFC after a print job until you hear the final click.

- 3 Plug the MFC into the AC outlet again. And leave it for 5 seconds.

Lock the Scanner Lock

- 4 Push the blue Scanner Lock Lever up to lock the scanner. This lever is located on the rear left underside of the scanner cover.

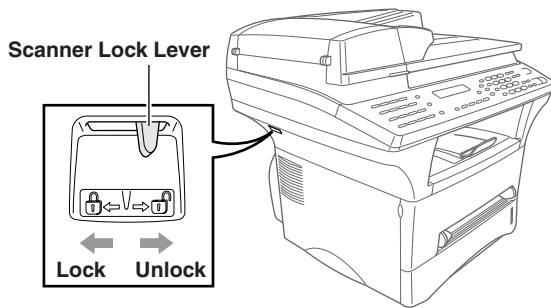

! Caution

If the message **CHECK SCAN LOCK** appears on the LCD, unlock the scanner immediately, and then press **Stop/Exit**.

! WARNING

Damage caused to your MFC by failure to lock the scanner before moving and shipping will void your warranty.

- 5 Open the front cover.
- 6 Remove the drum unit.

Caution

Remove the drum unit and toner cartridge assembly. Leave the toner cartridge installed in the drum unit.

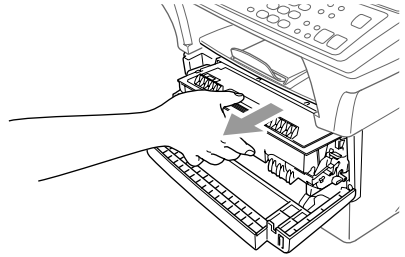

- 7 Place the drum unit and toner cartridge assembly into the plastic bag and seal the bag.

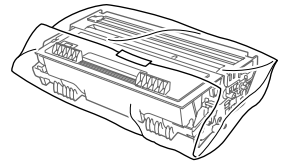

- 8 Close the front cover. Fold down the front output bin extension. Remove the telephone line cord.
- 9 Wrap the MFC in the plastic bag and place it in the original carton box with the original packing material.

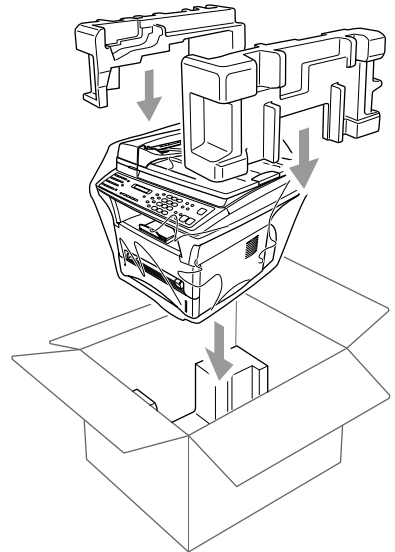
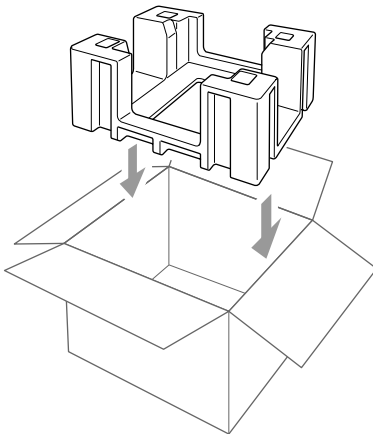

- 10** Pack the drum unit, toner cartridge assembly parallel cable, telephone line cord, AC cord and printed materials in the original carton as shown below:

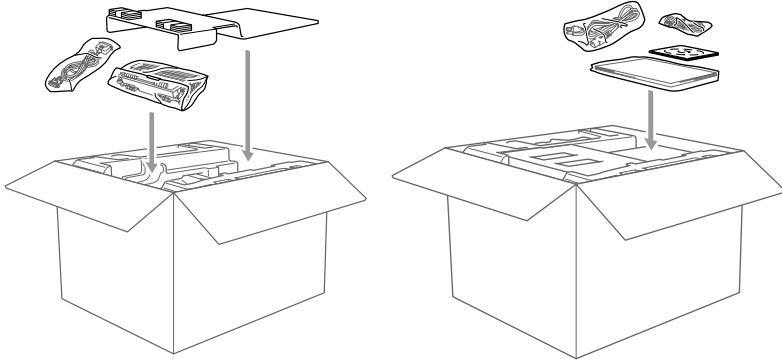

Note If you are returning the MFC to Brother as part of the Exchange Service, pack *only* the MFC. Keep all separate parts to use with your “Exchange” machine.

- 11** Close the carton and tape it shut.

Routine Maintenance

Cleaning the Scanner

Unplug the MFC and lift the document cover. Clean the scanner glass and the white film with isopropyl alcohol on a lint free cloth.

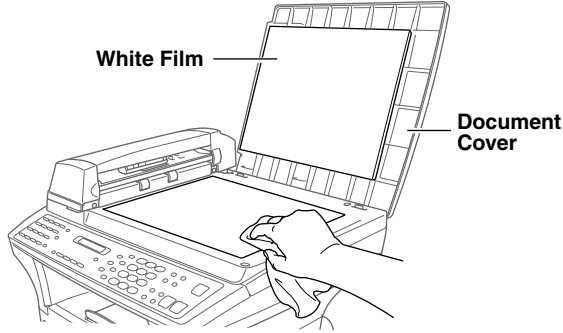

Lift the ADF unit. Clean the white roller and the glass strip under the roller with isopropyl alcohol on a lint-free cloth.

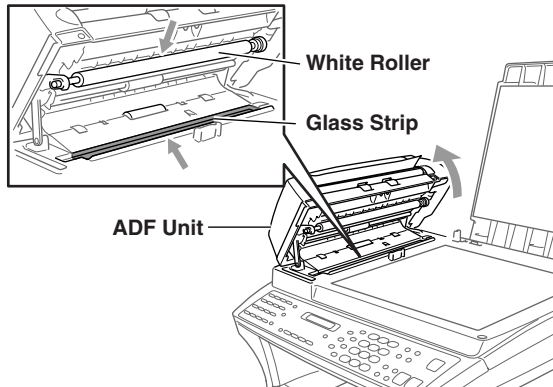

If the screen *still* displays a scanner error, call Brother Customer Service for assistance at 1-800-284-4329 (in USA), 1-877-BROTHER (in Canada), or 1-514-685-6464 (in Montreal).

Cleaning the Printer

! Caution

- Do *not* use isopropyl alcohol to remove dirt from the control panel. It may crack the panel.
- Do *not* use isopropyl alcohol to clean the scanner window or toner sensor.
- Do *not* touch the scanner window with your finger.
- The drum unit contains toner, so handle it carefully. If toner scatters and your hands or clothes get dirty, immediately wipe or wash it off with cold water.

- 1 Open the front cover.
- 2 Remove the drum unit assembly.

! WARNING

Just after you have used the MFC, some internal parts of the MFC are extremely **HOT!** When you open the front cover of the MFC, never touch the shaded parts as shown in the diagram below.

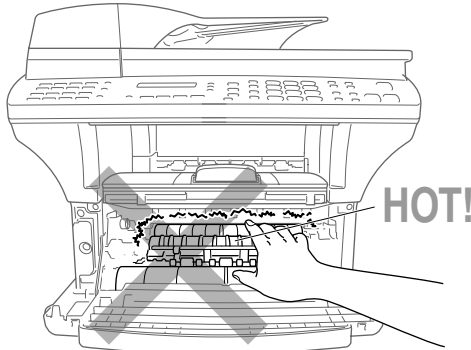

Front view

- 3 Gently clean the scanner window by wiping with a clean soft dry cloth. Do *not* use isopropyl alcohol.

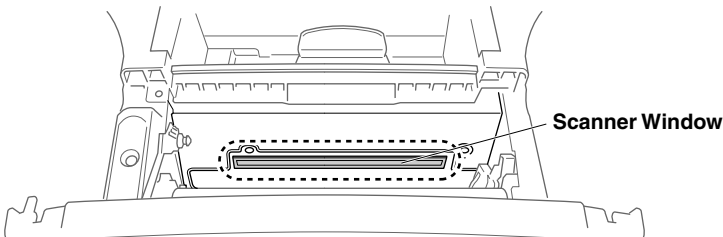

Cleaning the Drum Unit

We recommend placing the drum unit on a drop cloth or large disposable paper to avoid spilling and scattering toner.

- 1 Clean the primary corona wire inside the drum unit by gently sliding the tab from right to left several times.
- 2 Return the tab and snap it into the Home position (▼).

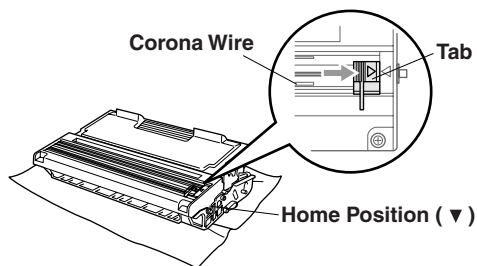

! Caution

If the tab is not at Home position (▼), printed pages may have vertical stripes.

- 3 Reinstall the drum unit into the MFC.
(See *Replacing the Drum Unit*, page 21-21.)
- 4 Close the front cover.
- 5 Plug in the power cord *first*, then the telephone cord.

Replacing the Toner Cartridge

The MFC can print *up to* 6,000 pages using a *high yield* toner cartridge. When the toner cartridge is running low, the LCD shows **TONER LOW**. The MFC is supplied with a *standard* toner cartridge that must be replaced after approximately 3,000 pages. Actual page count will vary depending on your average document type (i.e., standard letter, detailed graphics).



It is a good idea to keep a new toner cartridge ready for use when you see the **TONER LOW** warning.

Discard the used toner cartridge according to local regulations. If you are not sure of them, your local Sanitation Department. Be sure to seal the toner cartridge tightly so toner powder does not spill out of the cartridge. When discarding used toner cartridges, keep them separate from domestic garbage.

We recommend that you clean the MFC when you replace the toner cartridge.

How to Replace the Toner Cartridge

WARNING

Just after you use the MFC, some internal parts of the MFC will be extremely **HOT!** So, never touch the shaded parts shown in the illustration.

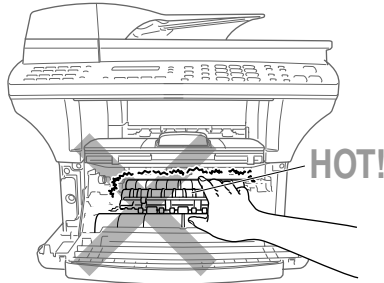

- 1 Open the front cover and pull out the drum unit.

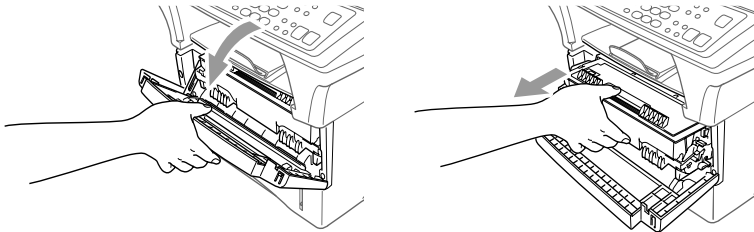

Place the drum unit on a drop cloth or large piece of disposable paper to avoid spilling and scattering the toner.

- 2 Hold down the lock lever on the right and pull the toner cartridge out of the drum unit assembly.

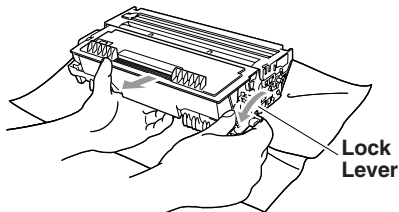

Caution

Handle the toner cartridge carefully. If toner scatters on your hands or clothes, immediately wipe it off or wash it with cold water.

- 3 Unpack the new toner cartridge. Place the used toner cartridge into the aluminum bag and discard it according to local regulations.

! Caution

- Wait to unpack the toner cartridge until immediately before you install it in the MFC. If a toner cartridge is left unpacked for a long period of time, the toner life is shortened.
 - You can use only a genuine Brother toner cartridge (**TN-430 or TN-460**), which is specially formulated to ensure top print quality. Using another brand of toner cartridge may void your MFC's warranty. Warranty coverage does not apply to problems caused by the use of 3rd party Toner, 3rd party Toner Cartridge or 3rd party Drum unit.
- 4 Gently rock the toner cartridge from side to side five or six times to distribute the toner evenly inside the cartridge.

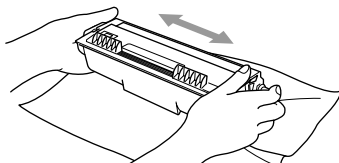

- 5 Remove the protective cover.

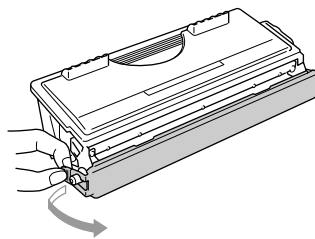

- 6 Insert the new toner cartridge in the drum unit until it clicks into place.

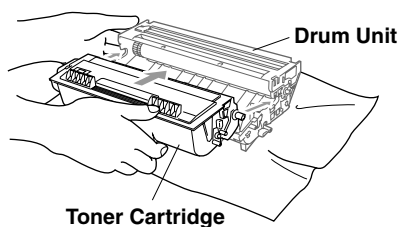

- 7 Clean the primary corona wire inside the drum unit by gently sliding the blue tab from right to left several times. Return the blue tab to the Home position (▼) before reinstalling the drum unit assembly.

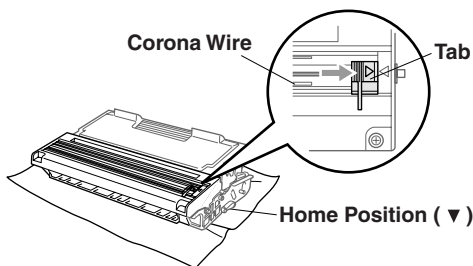

- 8 Reinstall the drum unit and close the front cover.

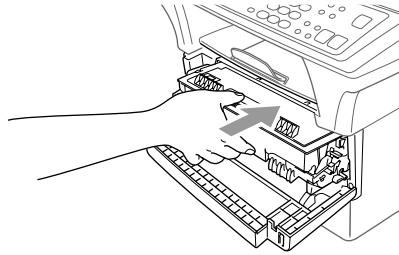

Replacing the Drum Unit

The MFC uses a drum unit to create print images on paper. If the LCD shows **CHANGE DRUM SOON**, the drum unit is near the end of its life and it is time to purchase a new one.

Even if the LCD shows **CHANGE DRUM SOON**, you may be able to continue printing without having to replace the drum unit for a while. However, if there is a noticeable deterioration in the output print quality (even before **CHANGE DRUM SOON** appears), then the drum unit should be replaced. You should clean the MFC when you replace the drum unit. (See page 21-18.)

! Caution

When removing the drum unit, handle it carefully because it contains toner. If toner scatters and your hands or clothes get dirty, immediately wipe or wash with cold water.



The drum unit is a consumable item, and it is necessary to replace it periodically.

There are many factors that determine the actual drum life, such as temperature, humidity, type of paper and how much toner you use for the number of pages per print job. The estimated drum life is *up to* 20,000 pages. The actual number of pages your drum will print may be significantly less than these estimates. Because we have no control over the many factors that determine the actual drum life, we cannot guarantee a minimum number of pages that will be printed by your drum.

! WARNING

Just after you have used the MFC, some internal parts of the MFC are extremely **HOT!** So please be careful.

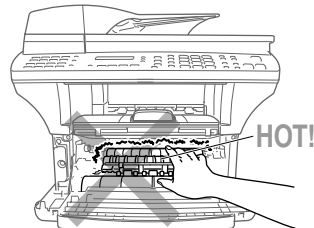

Follow these steps to replace the drum unit:

- 1 Open the front cover.
- 2 Remove the old drum unit. Place the drum unit on a drop cloth or disposable paper to avoid scattering toner.

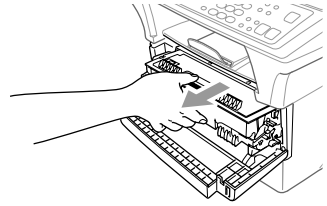

- 3 Hold down the lock lever on the right and pull the toner cartridge out of the drum unit assembly. (See *Replacing the Toner Cartridge*, page 21-18.)

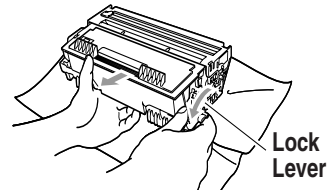

- 4 Discard the used drum unit according to local regulations. If you are not sure of them, call your local Sanitation Department. Be sure to seal the drum unit tightly so toner powder does not spill out of the unit. When discarding used drum units, keep them separate from domestic garbage.
- 5 Wait to unpack the new drum unit until immediately before installing it. Place the old drum unit into the aluminium bag and discard it according to local regulations.
- 6 Reinstall the toner cartridge into the new drum unit. (See *Replacing the Toner Cartridge*, page 21-18.)
- 7 Reinstall the new drum unit, keeping the front cover *open*.
- 8 Press **▶**.
- 8 Press **1** and when the LCD shows **ACCEPTED**, and close the front cover.

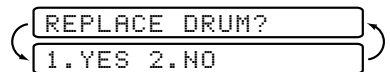

! Caution

If toner scatters and your hands or clothes get dirty, immediately wipe off or wash with cold water.

Checking the Drum Life

You can see the percentage of the drum's life that remains available.

- 1 Press **Menu, 2, 0, 3**.
- 2 For five seconds, the LCD shows the available percentage of drum life.

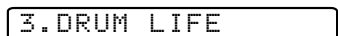

- 3 Even if the remaining drum life is 0%, you may continue to use the drum unit until you have a print quality problem.

22 Important Information

Standard Telephone and FCC Notices

These notices are in effect on models sold and used in the United States only.

When programming emergency numbers and/or making test calls to emergency numbers:

- Remain on the line and briefly explain to the dispatcher the reason for the call before hanging up.
- Perform these activities in the off-peak hours, such as early morning or late evening.

This equipment complies with Part 68 of FCC Rules. On the rear panel of this equipment is a label that contains, among other information, the FCC Registration Number and Ringer Equivalence Number (REN) for this equipment. You must, upon request, provide this information to your telephone company.

You may safely connect this equipment to the telephone line by means of a standard modular jack, USOC RJ11C.

An FCC compliant telephone cord with a modular plug is provided with this equipment. This equipment is designed to be connected to the telephone line or premise's wiring using a compatible modular jack that is Part 68 compliant. See the Installation section of this manual for details.

The REN is useful in determining the quantity of devices you may connect to your telephone line and still have those devices ring when your telephone number is called. In most, but not all areas, the sum of the RENs of all devices connected to one line should not exceed five (5).

To be certain of the number of devices you may connect to your line, as determined by the REN, you should contact your local telephone company to determine the maximum REN for your calling area. If MFC-9700 damages the telephone line, the telephone company may discontinue your service temporarily. If possible, they will notify you in advance. If advanced notice is not practical, you will be notified as soon as possible. You will be informed of your right to file a complaint with the FCC.

Your telephone company may make changes to its facilities, equipment, operations or procedures that could affect the proper functioning of your equipment. If they do, you will be notified in advance to give you an opportunity to maintain uninterrupted telephone service.

If you experience trouble with MFC-9700, please contact a Brother Authorized Service Center for information on service or repair. The telephone company may ask that you disconnect this equipment from the line until the problem has been corrected or until you are sure that the equipment is not malfunctioning.

If you are not able to solve a problem with your multi-function center, contact Brother Customer Service. (See *Brother Numbers*, page i.)

WARNING

For protection against the risk of electrical shock, always disconnect all cables from the wall outlet before servicing, modifying or installing the equipment.

This equipment may not be used on coin service lines provided by the telephone company or connected to party lines.

Brother cannot accept any financial or other responsibilities that may be the result of your use of this information, including direct, special or consequential damages. There are no warranties extended or granted by this document.

Laser Safety

This equipment is certified as a Class I laser product under the U.S. Department of Health and Human Services (DHHS) Radiation Performance Standard according to the Radiation Control for Health and Safety Act of 1968. This means that the equipment does not produce hazardous laser radiation.

Since radiation emitted inside the equipment is completely confined within protective housings and external covers, the laser beam cannot escape from the machine during any phase of user operation.

FDA Regulations

U.S. Food and Drug Administration (FDA) has implemented regulations for laser products manufactured on and after August 2, 1976. Compliance is mandatory for products marketed in the United States. The following label on the back of the machine indicates compliance with the FDA regulations and must be attached to laser products marketed in the United States.

Manufactured:

BROTHER CORP. (ASIA) LTD.

BROTHER BUJI NAN LING FACTORY

Gold Garden Industry, Nan Ling Village, Buji, Rong Gang, Shenzhen, China.

This product complies with FDA radiation performance standards,
21 CFR Subchapter J.

WARNING

Use of controls, adjustments or performance of procedures other than those specified in this manual may result in hazardous invisible radiation exposure.

Caution

Changes or modifications not expressly approved by Brother Industries, Ltd. may void the user's authority to operate the equipment.

Internal laser radiation

Max. Radiation Power	5 mW
Wave Length	760 - 810 nm
Laser Class	Class IIIb (Accordance with 21 CFR Part 1040.10)

Federal Communications Commission (FCC) Declaration of Conformity (For USA Only)

Responsible Party: Brother International Corporation
100 Somerset Corporate Boulevard
Bridgewater, NJ 08807-0911 USA
TEL: (908) 704-1700

declares, that the products

Product Name: MFC-9700

comply with Part 15 of the FCC Rules. Operation is subject to the following two conditions: (1) This device may not cause harmful interference, and (2) this device must accept any interference received, including interference that may cause undesired operation.

This equipment has been tested and found to comply with the limits for a Class B digital device, pursuant to Part 15 of the FCC Rules. These limits are designed to provide reasonable protection against harmful interference in a residential installation. This equipment generates, uses, and can radiate radio frequency energy and, if not installed and used in accordance with the instructions, may cause harmful interference to radio communications. However, there is no guarantee that interference will not occur in a particular installation. If this equipment does cause harmful interference to radio or television reception, which can be determined by turning the equipment off and on, the user is encouraged to try to correct the interference by one or more of the following measures:

- Reorient or relocate the receiving antenna.
- Increase the separation between the equipment and receiver.
 - Connect the equipment into an outlet on a circuit different from that to which the receiver is connected.
 - Consult the dealer or an experienced radio/TV technician for help.

Important

Changes or modifications not expressly approved by Brother Industries, Ltd. could void the user's authority to operate the equipment.

Industry Canada Compliance Statement (For Canada Only)

This Class B digital apparatus complies with Canadian ICES-003.

Cet appareil numérique de la classe B est conforme à la norme NMB-003 du Canada.

Important – About the Interface Cable

A shielded interface cable should be used to ensure compliance with the limits for a Class B digital device.

Warranty

You must use the IEEE-1284 shielded parallel cable provided by Brother Industries, Ltd. (See *Ordering Accessories and Supplies*, page ii)

International ENERGY STAR® Compliance Statement

As an ENERGY STAR® Partner, Brother Industries, Ltd. has determined that product meets the ENERGY STAR® guidelines for energy efficiency.



Important Safety Instructions

- 1** Read all of these instructions.
- 2** Save them for later reference.
- 3** Follow all warnings and instructions marked on the product.
- 4** Unplug this product from the wall outlet before cleaning. Do not use liquid or aerosol cleaners. Use a damp cloth for cleaning.
- 5** Do not place this product on an unstable cart, stand, or table. The product may fall, causing serious damage to the product.
- 6** Slots and openings in the cabinet and the back or bottom are provided for ventilation. To ensure reliable operation of the product and to protect it from overheating, these openings must not be blocked or covered. The openings should never be blocked by placing the product on a bed, sofa, rug, or other similar surface; near or over a radiator or heater; or in a built-in wall unit or cabinet without ventilation.
- 7** This product should be operated from the type of power source indicated on the label. If you are not sure of the type of power available, consult your dealer or local power company.
- 8** Use only the power cord supplied with this machine.
- 9** This product is equipped with a 3-wire grounding type plug, a plug having a third (grounding) pin. This plug will fit into only a grounding-type power outlet. This is a safety feature. If you are unable to insert the plug into the outlet, contact your electrician to replace your obsolete outlet. Do not defeat the purpose of the grounding-type plug, by using an adapter.
- 10** Do not allow anything to rest on the power cord. Do not place this product where people can walk on the cord.
- 11** If an extension cord is used with this product, make sure that the total ampere ratings on the products plugged into the extension cord do not exceed the extension cord ampere rating. The total of all products plugged into the wall outlet must not exceed 15 amperes (USA only).
- 12** Never push objects of any kind into this product through cabinet slots, since they may touch dangerous voltage points or short out parts resulting in the risk of fire or electric shock. Never spill liquid of any kind on the product.
- 13** This product has no ON/OFF switch. In case the main power to the machine must be disconnected quickly, it is very important that you have easy access to the main plug and the main socket where the plug is connected.

- 14** Unplug this product from the wall outlet and refer servicing to a Brother Authorized Service Center under the following conditions:
- A When the power cord is damaged or frayed.
 - B If liquid has been spilled into the product.
 - C If the product has been exposed to rain or water.
 - D If the product does not operate normally when the operating instructions are followed. Adjust only those controls that are covered by the operating instructions. Improper adjustment of other controls may result in damage and will often require extensive work by a qualified technician to restore the product to normal operation.
 - E If the product has been dropped or the cabinet has been damaged.
 - F If the product exhibits a distinct change in performance, indicating a need for service.
- 15** Do not attempt to service this product yourself, as opening or removing covers may expose you to dangerous voltage points and/or other risks, and may void your warranty. Refer all servicing to a Brother Authorized Service Center. A list of Brother Authorized Service Centers has been included for your convenience, or you may contact Brother Customer Service numbers for your nearest Brother Authorized Service Center. (See *Brother Numbers*, page i.)
- 16** To protect your product against power surges, we recommend the use of a power protection device (Surge Protector).
- 17** When using your telephone equipment, basic safety precautions should always be followed to reduce the risk of fire, electric shock and injury to persons, including the following:
- Do not use this product near appliances that use water, a swimming pool or in a wet basement.
 - Do not use the machine's telephone during an electrical storm (there is the remote possibility of an electrical shock) or to report a gas leak in the vicinity of the leak.
 - Use only the power cord indicated in this manual.

Trademarks

Brother is a registered trademark of Brother Industries, Ltd.

The Brother logo is a registered trademark of Brother Industries, Ltd.

Multi-Function Link is a registered trademark of Brother Industries, Ltd.

© Copyright 1996–2001 Brother Industries, Ltd. All rights reserved.

TextBridge and PaperPort are registered trademarks of ScanSoft, Inc.

Windows and Windows NT, Microsoft, MS-DOS, Excel and Word are registered trademarks of Microsoft in the U.S. and other countries.

NT is a trademark of Northern Telecom Limited.

Macintosh and Quick Draw are registered trademarks and iMac, iBook and TrueType are trademarks of Apple Computer, Inc.

Centronics is a trademark of Genicom Corporation.

Epson is a registered trademark and FX-80 and FX-850 are trademarks of Seiko Epson Corporation.

Hewlett Packard is a registered trademark and HP LaserJet II, IIP, and IID are trademarks of Hewlett-Packard Company.

IBM, IBM PC, and Proprinter are registered trademarks of International Business Machines Corporation.

Hammermill copyplus white is a registered trademark of International Paper.

All other terms and brand and product names mentioned in this manual are registered trademarks of their respective companies.

Glossary

- ADF (Automatic Document Feeder)** Originals can be placed in the ADF and scanned one at a time automatically.
- Auto Dial List** A listing of names and numbers stored in One Touch and Speed Dial memory, in numerical order.
- Automatic E-Mail Printing** Software application that automatically prints incoming e-mail messages on the MFC (Instructions are on CD-ROM 1).
- Automatic Redial** If the fax did not go through because the line was busy or there was no answer, the MFC redials the number.
- auto reduction** Reduces the size of incoming faxes.
- Backup Print** Sets your MFC to print a copy of faxes that are received and stored in memory.
- Batch Transmission** As a cost savings feature, all delayed faxes to the same fax number will be sent as one transmission.
- Beeper** The sound the keys make when they are pressed, an error occurs or a document has been received or transmitted.
- beeper volume** Volume setting for the beep when you press a key or make an error.
- Broadcasting** The ability to send the same fax message to more than one location.
- Brother Control Center** A window that enables you to click on a button to choose the type of scanning operation you want to perform. If you set up the Control Center window to load each time you boot your PC, this window will appear each time you place a original in the ADF.
- Caller ID** A service purchased from the Telephone Company that lets you see the number (or name) of the party calling you. Your MFC stores the latest callers so you can print a Log, view caller information, register selected callers as auto dial numbers.
- Cancel Job** Cancels a programmed job, like Delayed Fax or Polling.
- CNG tones** The special tones (beeps) sent by fax machines during automatic transmission to tell the receiving MFC that a MFC is calling.
- communication error (or Comm. Error)** An error during fax sending or receiving, usually caused by line noise or static.
- coding method** Method of coding the information contained in an original. All fax machines must use a minimum standard of Modified Huffman (MH). Your MFC is capable of greater compression methods, Modified Read (MR) Modified Modified Read (MMR) and Joint Bi-level Image export working Group (JBIG) if the receiving MFC has the same capability.
- compatibility group** The ability of one fax unit to communicate with another. Compatibility is assured between ITU-T Groups.
- Contrast** A setting that compensates for dark or light originals, by lightening dark documents or darkening light originals.

Cover Page Prints a page at the other party's MFC that contains the sender and recipient's name and fax number, number of pages and comment. You can generate an electronic cover page at the other end with pre-programmed information from memory or you can print a sample cover page to fax with your original.

Cover Page Message The comment that is on the Cover Page. This is a programmable feature.

Delayed Fax Sends your fax at a later time that day.

Delayed Timer You can program a certain time each day that all delayed faxes will be sent on a first come/first served basis.

Distinctive Ring A service purchased from your telephone company that provides another phone number on an existing phone line. The Brother MFC uses the new number to simulate a dedicated fax line.

Dual Access Your MFC can scan outgoing faxes or scheduled jobs into memory at the same time it is sending a fax or receiving or printing an incoming fax.

Easy Receive Enables your MFC to respond to CNG tones if you interrupt a fax call by answering it.

ECM (Error Correction Mode) Detects errors during fax transmission and automatically resends the page(s) that had an error.

Electronic Cover Page A preprogrammed cover page that is transmitted from the MFC's memory, eliminating the need for making up cover pages manually.

extension phone A telephone on the fax number that is plugged into a separate wall jack.

external phone A TAD (telephone answering device) or telephone that is plugged into the EXT jack of your MFC.

Fax Activity Report Lists information about the last 200 incoming and outgoing faxes. TX means Transmit. RX means Receive.

Fax Forwarding Sends a fax received in memory to another preprogrammed fax number.

Fax Storage You can print stored faxes later, or retrieve them from another location using Fax Forwarding, Paging, or Remote Retrieval commands.

fax tones The signals sent by sending and receiving fax machines while communicating information.

Fine Mode Resolution is 203 × 196 dpi. It is used for small print and graphs.

gray scale The shades of gray available for copying and faxing photographs.

Group number A combination of One Touch and Speed Dial numbers that are stored on a One Touch key for Broadcasting.

Help List By pressing the **Reports** key and **1**, you can get a printout of the complete Menu so you can use it to program your MFC when you do not have the Owner's Manual with you.

interval The preprogrammed time period between automatically printed Fax Activity Reports. You can print Activity Reports on demand without interrupting this cycle.

LCD (liquid crystal display) The display screen on the MFC that shows interactive messages during On-Screen Programming and defaults to the date and time when the MFC is idle.

Menu mode Programming mode for changing the settings of your MFC.

- Multi-Function Link® Pro Suite software** Turns your MFC into a printer and a scanner and enables PC faxing using the MFC.
- OCR (optical character recognition)** The bundled ScanSoft® TextBridge® software application converts an image of text to text that you can edit.
- One Touch** Keys on the MFC control panel where you can store numbers for easy dialing. You must use a separate key for each number.
- Out of Paper Reception** Receives faxes into the MFC's memory when the MFC is out of paper.
- Overseas mode** Makes temporary changes to the fax tones to accommodate noise and static on overseas phone lines.
- Paging** Feature enables your fax unit to call your pager when a fax message is received into its memory.
- Pause** Allows you to place a 3.5 second delay in the dialing sequence stored on One Touch and Speed Dial numbers.
- Photo mode** A resolution setting that uses varying shades of gray for the best representation of photographs.
- Polling** The process of a fax machine calling another fax machine to retrieve waiting fax messages.
- Pulse (for Canada only)** A form of dialing on a telephone line.
- Real Time Transmission** When memory is full, send documents in real time.
- Remaining Jobs** You can check which jobs are waiting in memory and cancel jobs individually.
- Remote Retrieval Access** The ability to access your MFC remotely from a touch tone phone.
- Remote Retrieval Access Code** The four-digit code (159*) that allows you to call your MFC to retrieve fax messages or change fax storage settings.
- Remote Activation** Allows you to transfer a fax call, answered at an external or extension phone, to the MFC.
- Resolution** The number of vertical and horizontal lines per inch. See: Standard, Super Fine and Photo.
- Ring Delay** The number of rings before the MFC answers in FAX mode.
- Ring Volume** Volume setting for the MFC's ring.
- scanning** The process of sending an electronic image of an original paper document into your computer.
- ScanSoft® PaperPort® for Brother** Document management application where you can view received faxes and scanned originals.
- ScanSoft® TextBridge®** Optional Character Recognition (OCR) software that converts a scanned image of text into text you can edit in your word processing application.
- Search** You can scroll through an alphabetical listing on the LCD of the One Touch and Speed Dial numbers you stored.
- Speed Dial** A preprogrammed number for easy dialing. You must press the Speed dial button and then two digit code to start the dialing process.

Standard resolution 203 × 98 dpi. It is used for regular size text and quickest transmission.

Station ID The stored information that appears on the top of faxed pages. It includes the sender's name and fax number.

Super Fine resolution 203 × 392 dpi. Best for very small print and line art.

TAD (telephone answering device) You can connect an external TAD to the EXT. jack for EXT. TEL/TAD mode.

temporary settings You can select certain options for each fax transmission or copy you make without changing the default settings.

Tone A form of dialing on the telephone line used for Touch Tone telephones.

transmission The process of sending documents over the phone lines from your MFC to the receiving MFC.

Transmission Verification Report A listing of each transmission, showing caller ID, date, time, and number of pages.

True Type fonts The fonts that are used in the Windows® operating systems. If you install the Brother True Type fonts, more types of fonts will be available for Windows® applications.

User Settings List Printed report of your MFC's settings.

S Specifications

Product Description

Six performance modes are available for the 5in1 model MFC-9700:
Fax, Printer, Copier, Scanner and PC Fax.

Fax

Compatibility	ITU-T Group 3
Coding System	MH/MR/MMR/JBIG
Modem Speed	14400/12000/9600/7200/4800/2400 Automatic Fallback
Document Size	ADF Width: 5.8" to 8.5" (148 mm to 216 mm) ADF Length: 5.0" to 14.0" (127 mm to 356 mm) Scanner Width: Max. 8.5" (216 mm) Scanner Length: Max. 11.7" (297 mm)
Automatic Document Feeder (ADF)	Up to 50 pages*
Scanning/Printing Width	8.2 inches (208 mm)
Paper Cassette	250 Sheets (20 lbs.)
Gray Scale	64 levels
Display	LCD, 16 characters
Polling Types	Standard, Sequential
Contrast Control	Automatic/Super Light/Super Dark (manual setting)
Resolution	<ul style="list-style-type: none">• Horizontal 203 dot/inch (8 dot/mm)• Vertical Standard—98 line/inch (3.85 line/mm) Fine, Photo—196 line/inch (7.7 line/mm) Superfine, Photo—392 line/inch (15.4 line/mm)
Memory Capacity	8 MB (up to 600 pages)*
One Touch Dial	4 × 2
Speed Dial	100 stations
Automatic Redial	3 times at 5 minute intervals
Auto Answer	0, 1, 2, 3, 4 or 5 rings

* “pages” refers to the “Brother Standard Chart No.1” (a typical business letter, Standard resolution). Specifications and printed materials are subject to change without prior notice.

Fax (Continued)

Communication Source	Public switched telephone network.
Temperature	(Allowable) 50 - 90.5° F (10 - 32.5° C) (Storage) 32 - 104° F (0 - 40° C)
Warm-Up	Max. 37 seconds at 73.4° F (23° C)
First Print	Up to 15 seconds (using Letter size paper in paper cassette)
Power Source	120V AC 50/60Hz (Canadian Version Only)
Power Consumption	Average Operating (Copying): 350 W (25° C) Peak: 940 W Sleep: 15 W or less Standby: 75 W or less (25° C)
Noise	Operating: 53 dB A or less Stand by: 30 dB A or less
Humidity	Operating: 20 to 80% (without condensation) Storage: 20 to 80% (without condensation)
Dimensions	19.4 × 18.0 × 16.8 inches/(492 × 456 × 429 mm)
Weight	35.2 lbs/(17 kg)

Printer

Emulation	Brother Printing System for Windows® and emulation mode of HP LaserJet IIP (PCL level 4)
Printer Driver	Windows® 95/98/98SE/Me/2000 and Windows NT® Workstation Version 4.0 driver supporting Brother Native Compression mode and bi-directional capability Apple® Macintosh® QuickDraw® Driver for OS 8.5/8.51/8.6/9.0/9.0.4/9.1
Interface	Bi-directional parallel (IEEE-1284); USB (Universal Serial Bus) 1.1
Memory Capacity	8 MB
Print Method	Electrophotography by semiconductor laser beam scanning
Resolution	600 dots/inch

Print Quality

Normal printing mode
Economy printing mode (saves up to 50% of the normal toner usage)

Print Speed

Up to 15 pages/minute (when loading letter size paper from paper cassette)

Consumable Items

Toner cartridge Life Expectancy:
Up to 6,000 pages/*high yield* toner cartridges
Up to 3,000 pages/*standard* toner cartridges
(when printing letter size or A4 paper at 5% print coverage)



Toner life expectancy will vary depending upon the type of average print job.
Drum Unit Life Expectancy: up to 20,000 pages



There are many factors that determine the actual drum life, such as temperature, humidity, type of paper, toner you use and number of pages per print job.

True Type Fonts on CD-ROM

35 TrueType compatible soft-fonts for Windows® on the bundled CD-ROM

Computer Requirements

For Windows®			
Operating System	CPU (Pentium)	RAM	Hard Disk Space
95, 98, 98SE	75MHz	24MB (32MB recommended)	50MB
NT Workstation 4.0	75MHz	32MB (64MB recommended)	
2000 Professional	133MHz	64MB (128MB recommended)	
Me	150MHz	32MB (64MB recommended)	

For Macintosh®			
Operating System	CPU	RAM	Hard Disk Space
Apple® Macintosh® QuickDraw® G3, G4, iMac or iBook with OS 8.5, 8.5.1 (Only Printer) OS 8.6/9.0/9.0.4/9.1 (Printer & Scanner)	All base models meet minimum requirements.		50MB

Parallel Interface

Interface Connector Printer Side: Amphenol FCN-685J036-L/X or equivalent
A shielded cable should be used.

Pin Assignment

Pin No.	Signal	Direction	Pin No.	Signal	Direction
1	DATA STROBE	Input	19	0V(S.G.)	-
2	DATA 1	Input	20	0V(S.G.)	-
3	DATA 2	Input	21	0V(S.G.)	-
4	DATA 3	Input	22	0V(S.G.)	-
5	DATA 4	Input	23	0V(S.G.)	-
6	DATA 5	Input	24	0V(S.G.)	-
7	DATA 6	Input	25	0V(S.G.)	-
8	DATA 7	Input	26	0V(S.G.)	-
9	DATA 8	Input	27	0V(S.G.)	-
10	$\overline{\text{ACKNLG}}$	Output	28	0V(S.G.)	-
11	BUSY	Output	29	0V(S.G.)	-
12	PE	Output	30	0V(S.G.)	-
13	SLCT	Output	31	$\overline{\text{INPUT PRIME}}$	Input
14	$\overline{\text{AUTO FEED}}$	Input	32	$\overline{\text{FAULT}}$	Output
15	N.C.	-	33	N.C.	-
16	0V (S.G.)	-	34	N.C.	-
17	0V (S.G.)	-	35	N.C.	-
18	+5V	-	36	$\overline{\text{SLCT IN}}$	Input

USB (Universal Serial Bus) Interface

Pin Assignment

Pin No.	Signal	
1	Vol (+5V)	
2	- Data	Serial Data -
3	+ Data	Serial Data +
4	Ground	

Resident Fonts

The following bitmapped fonts are resident in the MFC.

Brougham 10 (12 point) upright/normal

Brougham 12 (10 point) upright/normal

Letter Gothic 16.66 (8.5 point) upright/normal

(Portrait and Landscape are available for the above.)

Symbol Sets/Character Sets

*HP mode

- ISO14 JIS ASCII
- ISO57 Chinese
- ISO11 Swedish
- HP Spanish
- ISO17 Spanish
- ISO10 Swedish
- ISO16 Portuguese
- ISO84 Portuguese
- ISO85 Spanish
- PC-8
- PC-8 D/N
- PC-8 Turkish
- PC-850
- PC-852
- PC-860
- PC-865
- Roman 8
- ISO Latin 1
- (ECMA-94)
- ISO60 Norwegian 1
- ISO61 Norwegian 2
- ISO4 UK
- ISO25 French
- ISO69 French
- HP German
- ISO21 German
- ISO15 Italian
- ISO6 ASCII
- Legal
- ISO2 IRV
- PC-863



If you want to know which characters are in each symbol/character set, print the CHARSETS.PRN file from “The Print Form” option in the Direct Access Menu of the Remote Printer Console Program.

□ HP LaserJet IIP

Roman 8

ISO Latin1

Roman 8										ISO Latin1																					
0	1	2	3	4	5	6	7	8	9	A	B	C	D	E	F	0	1	2	3	4	5	6	7	8	9	A	B	C	D	E	F
0	0	@	P	'	p					À	Á	Â	Ã	Ä	Å	0	0	@	P	'	p					À	Á	Â	Ã	Ä	Å
1	1	A	Q	a	q					À	Á	Â	Ã	Ä	Å	1	1	A	Q	a	q					À	Á	Â	Ã	Ä	Å
2	2	B	R	b	r					À	Á	Â	Ã	Ä	Å	2	2	B	R	b	r					À	Á	Â	Ã	Ä	Å
3	3	C	S	c	s					À	Á	Â	Ã	Ä	Å	3	3	C	S	c	s					À	Á	Â	Ã	Ä	Å
4	4	D	T	d	t					À	Á	Â	Ã	Ä	Å	4	4	D	T	d	t					À	Á	Â	Ã	Ä	Å
5	5	E	U	e	u					À	Á	Â	Ã	Ä	Å	5	5	E	U	e	u					À	Á	Â	Ã	Ä	Å
6	6	F	V	f	v					À	Á	Â	Ã	Ä	Å	6	6	F	V	f	v					À	Á	Â	Ã	Ä	Å
7	7	G	W	g	w					À	Á	Â	Ã	Ä	Å	7	7	G	W	g	w					À	Á	Â	Ã	Ä	Å
8	8	H	X	h	x					À	Á	Â	Ã	Ä	Å	8	8	H	X	h	x					À	Á	Â	Ã	Ä	Å
9	9	I	Y	i	y					À	Á	Â	Ã	Ä	Å	9	9	I	Y	i	y					À	Á	Â	Ã	Ä	Å
A	A	:	J	Z	j	z				À	Á	Â	Ã	Ä	Å	A	A	:	J	Z	j	z				À	Á	Â	Ã	Ä	Å
B	B	+	;	K	[k	{			À	Á	Â	Ã	Ä	Å	B	B	+	;	K	[k	{			À	Á	Â	Ã	Ä	Å
C	C	<	L	\	l					À	Á	Â	Ã	Ä	Å	C	C	<	L	\	l					À	Á	Â	Ã	Ä	Å
D	D	-	=	M]m	}				À	Á	Â	Ã	Ä	Å	D	D	-	=	M]m	}				À	Á	Â	Ã	Ä	Å
E	E	.	>	N	^	n	-			À	Á	Â	Ã	Ä	Å	E	E	.	>	N	^	n	-			À	Á	Â	Ã	Ä	Å
F	F	/	?	O	_	o	⊗			À	Á	Â	Ã	Ä	Å	F	F	/	?	O	_	o	⊗			À	Á	Â	Ã	Ä	Å

The following table shows characters available only in the corresponding character set. The numbers at the top of the table are code values with which characters are to be replaced in the Roman 8 character set. For other characters, see character set of Roman 8.

SYMBOL SET	23	24	40	5B	5C	5D	5E	60	7B	7C	7D	7E
ISO2 IRV	#	□	@	[\]	^	~	{		}	—
ISO4 UK	E	\$	@	[\]	^	~	{		}	—
ISO6 ASCII	#	\$	@	[\]	^	~	{		}	—
ISO10 Swedish	#	□	@	Ä	Ö	Å	^	~	ä	ö	å	—
ISO11 Swedish	#	□	É	Ä	Ö	Å	Ü	é	ä	ö	å	ü
ISO14 JIS ASCII	#	\$	@	[V]	^	~	{		}	—
ISO15 Italian	E	\$	§	·	ç	é	^	ù	à	ò	è	ì
ISO16 Portuguese	#	\$	§	À	Ç	Õ	^	~	ã	ç	õ	·
ISO17 Spanish	E	\$	§	¡	Ñ	¿	^	~	•	ñ	ç	—
ISO21 German	#	\$	§	Ä	Ö	Ü	^	~	ä	ö	ü	ß
ISO25 French	E	\$	à	·	ç	§	^	~	é	ù	è	—
ISO57 Chinese	#	¥	@	{	\	}	^	~	{		}	—
ISO60 Norwegian1	#	\$	@	Æ	Ø	Å	^	~	æ	ø	å	—
ISO61 Norwegian2	§	\$	@	Æ	Ø	Å	^	~	æ	ø	å	
ISO69 French	E	\$	à	·	ç	§	^	μ	é	ù	è	—
ISO84 Portuguese	#	\$	·	À	Ç	Õ	^	~	ã	ç	õ	—
ISO85 Spanish	#	\$	·	¡	Ñ	Ç	¿	~	•	ñ	ç	—
HP German	E	\$	§	Ä	Ö	Ü	^	~	ä	ö	ü	ß
HP Spanish	#	\$	@	¡	Ñ	¿	·	~	{	ñ	}	—

Index

A

- access codes, storing and dialing 7-4
- accessories and Supplies ii
- ADF (Automatic Document Feeder)
 - size of original 6-1
- assembly and connections 2-4
 - drum unit 2-4
 - grounded 3-prong plug 2-8
 - loading paper 2-6
 - telephone line cord 2-8
 - toner cartridge 2-4
- automatic
 - dialing 7-3
 - fax receive 5-1
 - fax redial 6-4
 - transmission 6-4

B

- Broadcasting 7-5
 - setting up Groups for 7-2
- Brother
 - accessories and Supplies ii
 - Customer Service i
 - fax-back system i
 - Frequently Asked Questions (FAQs) i
 - product support i
 - test sheet, sending 1-2
 - warranties
 - Canada vi
 - Notice-Disclaimer of Warranties iii
 - USA iv
- Brother Control Center
 - using and configuring 15-1 to 15-15

C

- canceling
 - fax forwarding 9-4
 - fax jobs in memory 5-6, 6-6
 - jobs awaiting redial 6-6
 - paging 9-4

- cleaning (routine maintenance)
 - drum unit 21-18
 - printer 21-17
 - scanner 21-16
- connecting 2-8
- copy 11-1
 - contrast 11-4
 - enlarging 11-3
 - photographs 11-9
 - quality 21-7
 - scannable area 11-1
 - single 11-1
 - using ADF 11-1
 - using scanner glass 11-2
- cover page
 - composing 6-7
 - custom comments 6-8
 - for all faxes 6-9
 - for next fax only 6-8
 - printed form 6-9
- credit card numbers, storing 7-4
- custom telephone features 2-13, 21-7
- Customer Service i

D

- Date and Time 4-2
- dialing
 - a pause 7-6
 - access codes 7-4
 - automatic fax redial 6-4
 - credit card numbers 7-4
 - fax redial 7-6
 - Groups 7-5
 - One Touch numbers 7-4
 - search 7-3
 - Speed Dial numbers 7-4
- drivers
 - Macintosh®
 - printer 19-1
 - scanner 19-1, 19-8

- Windows®
 - PC-FAX 17-15
 - printer 13-1, 14-1
 - scanner 16-4
- drum unit
 - checking remaining life 21-22
 - installing 2-4
 - replacing 21-21
- dual access 6-4

E

- Easy Receive 5-3
- ECM (Error Correction Mode) 1-6
- emergency numbers 22-1
- envelopes, sizes 2-5
- error messages on LCD 21-1
 - CHECK PAPER 21-1
 - NOT REGISTERED 21-2
 - OUT OF MEMORY 11-2
- extension telephone, using 5-4
- external telephone 2-9

F

- fax codes
 - changing 5-4
 - Fax Receive Code 5-4
 - Remote Retrieval Access Code 9-3
- Fax Forwarding
 - changing remotely 9-4, 9-5
 - programming a number 9-1
 - setting up at machine 9-1
- Fax Storage
 - printing from 5-5
 - setting 9-2
- fax, stand-alone
 - receiving 5-1
 - difficulties 21-6
 - erasing from memory 9-4
 - forwarding 9-1, 9-4
 - polling 5-5
 - printing from memory 5-5
 - reducing to fit on paper 5-3
 - retrieving from a remote site 9-5

- sending
 - automatic fax redial 6-4
 - automatic transmission 6-4
 - broadcasting 7-5
 - canceling from memory 6-6
 - contrast 6-6
 - delayed 6-10
 - from memory (dual access) 6-4
 - in real time 6-5
 - manual transmission 6-4
 - overseas 6-10
 - polling 6-11
 - resolution 6-7
 - timer for delayed sending 6-10
 - using multiple settings 6-1
 - using scanner glass 6-3
- FCC notices 22-1

G

- Groups
 - dialing 7-5

J

- jacks
 - converting telephone wall outlets 2-11
 - EXT. jack on MFC
 - TAD (answering machine) 2-9
 - EXT. jack on MFC external telephone 2-9
 - triplex adapter 2-11
- jams 21-3
 - original 21-3
 - paper 21-3, 21-5

L

- LCD (Liquid Crystal Display) 3-1

M

- Macintosh® G3, G4 or iMac™ 19-1
- maintenance, routine 21-1
- manual feed slot 2-5, 2-7
- manual transmission 6-4

multi-purpose sheet feeder 2-5, 2-6

O

OCR (ScanSoft™ TextBridge®) 16-1

One Touch numbers

- accessing with Shift key 7-1
- changing 7-2
- dialing 7-4
- listing 10-2
- storing 7-1

P

packing list 2-1

Paging, programming your pager number 9-1

paper

- jams 21-4
- loading 2-6
- size 2-5, 4-1
- specifications S-1

phone line

- connection 2-8
- difficulties 21-6, 21-7
- multi-line (PBX) 2-13
- roll-over lines 2-11
- two-line system 2-11, 2-12

Polling 5-5

- receiving 5-5
- sending 6-11
- sequential receiving 5-6

power

- cord 2-8
- electrical outlet 2-8
- failure 4-5

print 13-1

- density 5-4
- difficulties 21-6
- driver 13-1
- emulation
 - Macintosh® 19-1
 - Windows® 13-1

Reset key (clear printer memory) 13-7

resolution 6-7, S-2

speed S-3

two-sided (manual duplexing) 13-2

programming at-a-glance 3-2

R

Real Time Transmission 6-5

Receive mode

- EXT.TEL/TAD 5-1
- FAX ONLY 5-1
- MANUAL 5-1

redial 6-4

remote printer console 13-1

Remote Retrieval 9-3

- access code using 9-3
- commands 9-4
- getting your faxes 9-5

reports 10-1

- HELP (programming at-a-glance) 10-2
- how to print 10-2
- list of your stored numbers 10-2
- Transmission Verification 10-2

resolution

- fax (Standard, Fine, Superfine, Photo) 6-7, S-1
- print S-2
- scan 16-5

Ring Delay, setting 5-2

S

Safety Instructions 22-5

Scan

- Macintosh® 19-7
- Windows® 16-1

Scanner Lock 2-3, 21-13

Setup

- Date and Time 4-2
- Station ID (fax header) 4-3

shipping the machine 21-13

simultaneous printing/faxing 13-6

software (Macintosh®)

- faxing 19-3
- Prescanning into Macintosh 19-11
- scanner settings 19-9

- Printing with Brother driver 19-1
- Scanning with Brother TWAIN driver 19-7
- software (Windows®)
 - Brother Control Center 15-1
 - for DOS users 12-1
 - PaperPort® for Brother 16-1
 - exporting an image file 16-4
 - PC-FAX 17-3
 - prescanning an image 16-7
 - scanning into PC 16-4, 16-5
 - uninstall 16-1
 - ScanSoft™ TextBridge® OCR 16-1
 - viewing faxes and files 16-2
- Speed Dial
 - changing 7-2
 - dialing 7-4
 - listing 10-2
 - storing 7-2

T

- TAD (telephone answering device)
 - connecting 2-9
 - Receive mode 5-1
 - recording outgoing message 2-10
- telephone external 2-9
- text, entering 4-4
 - corrections 4-4
 - special characters 4-4
- toner cartridge
 - installing 2-4
 - replacing 21-18, 21-19
 - toner saver 4-6
- transparencies 2-7
- troubleshooting 21-1
 - error messages on LCD 21-1
 - if you are having difficulty 21-6
 - copy quality 21-7
 - DOS setup 21-9
 - incoming calls 21-7
 - paper handling 21-10
 - phone line or connection 21-6
 - printer 21-7
 - printing or receiving faxes 21-6

- scanning 21-8
- sending faxes 21-6
- software 21-8
- two-line phone system 2-11, 2-12

U

- User Settings 10-2

V

- volume, setting
 - beeper 4-5
 - ring 4-5
 - speaker 4-5

W

- warranties
 - Canada vi
 - Notice of Disclaimer iii
 - USA iv
- World Wide Web i

Remote Retrieval Access Card

If you plan to receive fax messages while away from your machine, carrying the Remote Retrieval Access Card printed below will serve as a convenient reminder of the retrieval procedures. Simply cut out the card and fold it to fit your wallet or organizer. Keeping it handy will help you derive the full benefit of your machine's forwarding, paging and remote retrieval features.

REMOTE RETRIEVAL ACCESS CARD

CHECK RECEIVING STATUS
Press **9 7 1**
1 long beep — Fax message(s)
3 short beeps — No messages

CHANGE RECEIVE MODE
Press **9 8**
then for
EXT./TEL/TAD, press 1.
FAX, press 2.

EXIT REMOTE OPERATION
Press **9 0**.

Using Remote Retrieval Access Code

- 1 Dial your fax number from a fax machine using touch tone.
- 2 When your MFC answers and beeps, immediately enter your Remote Retrieval Access Code (159 ✳).
- 3 The MFC signals the kinds of messages received:
 - 1 long beep — Fax message(s)
 - No beeps — No messages.
- 4 After 2 short beeps, enter a command.
- 5 Press **9 0** to reset the MFC when you're finished.
- 6 Hang up.

Fold → ← Fold

1

4

Changing Remote Retrieval Access Code

- 1** Press **Menu 2, 5, 3**.
- 2** Enter a three-digit number from 000 to 999.
The * cannot be changed.
- 3** Press **Set**.
- 4** Press **Stop/Exit**.

Remote Commands

CHANGE PAGING/FAX FORWARDING SETTING

- Press **9, 5**
then to Turn feature off, press **1**.
- Select Fax Forwarding, press **2**.
- Select Paging, press **3**.

Program Fax Forwarding Number press **4**. Enter the new fax number where you want your fax messages forwarded followed by **# #**.

- Turn Fax Storage on, press **6**.
- Turn Fax Storage off, press **7**.

RETRIEVE A FAX

- Press **9 6**
then to Retrieve all faxes, press **2**
and then enter the number of the remote fax machine followed by **# #**. After the beep, hang up and wait.
- Erase all fax messages, press **3**.

EQUIPMENT ATTACHMENT LIMITATIONS (For Canada Only)

NOTICE:

The industry Canada label identifies certified equipment. This certification means that the equipment meets telecommunications network protective, operational and safety requirements as prescribed in the appropriate Terminal Equipment Technical Requirements document(s). The Department does not guarantee the equipment will operate to the user's satisfaction.

Before installing this equipment, users should ensure that it is permissible to be connected to the facilities of the local telecommunications company. The equipment must also be installed using an acceptable method of connection. The customer should be aware that compliance with the above conditions may not prevent degradation of service in some situations.

Repairs to certified equipment should be coordinated by a representative designated by the supplier. Any repairs or alterations made by the user to this equipment, or equipment malfunctions, may give the telecommunications company cause to request the user to disconnect the equipment.

Users should ensure for their own protection that the electrical ground connections of the power utility, telephone lines and internal metallic water pipe system, if present, are connected together. This precaution may be particularly important in rural areas.

Caution:

Users should not attempt to make such connections themselves, but should contact the appropriate electric inspection authority, or electrician, as appropriate.

NOTICE:

The Ringer Equivalence Number (REN) assigned to each terminal device provides an indication of the maximum number of terminals allowed to be connected to a telephone interface. The termination on an interface may consist of any combination of devices subject only to the requirement that the sum of the Ringer Equivalence Numbers of all the devices does not exceed 5 REN=0.2B



Brother International Corporation
100 Somerset Corporate Boulevard
P.O. Box 6911
Bridgewater, NJ 08807-0911 USA

Brother International Corporation (Canada) Ltd.
1 rue Hôtel de Ville,
Dollard-des-Ormeaux, QC, CANADA H9B 3H6

Visit us on the World Wide Web
<http://www.brother.com>

These machines are made for use in the USA and CANADA only. We cannot recommend using them overseas because it may violate the Telecommunications Regulations of that country and the power requirements of your multi-function center may not be compatible with the power available in foreign countries. **Using USA or CANADA models overseas is at your own risk and will void your warranty.**