

brother®

ADVANCED USER'S GUIDE

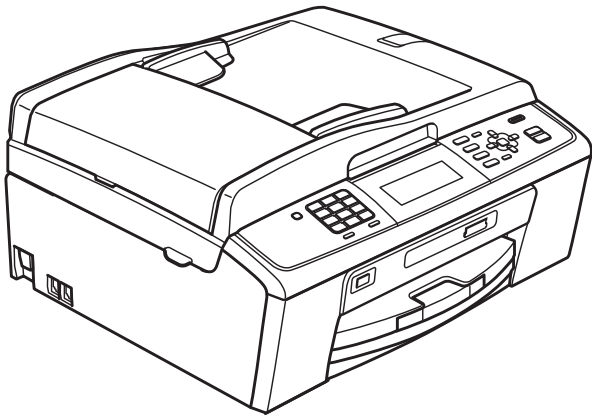

**MFC-J615W
MFC-J630W**

Version 0

USA/CAN

User's Guides and where do I find it?

Which manual?	What's in it?	Where is it?
Safety and Legal	Please read the Safety Instructions before you set up your machine.	Printed / In the box
Quick Setup Guide	Read this Guide first. Follow the instructions for setting up your machine and installing the drivers and software for the operating system and connection type you are using.	Printed / In the box
Basic User's Guide	Learn the basic Fax, Copy, Scan and PhotoCapture Center [®] operations and how to replace consumables. See troubleshooting tips.	Printed / In the box
Advanced User's Guide	Learn more advanced operations: Fax, Copy, security features, and printing reports. Perform routine maintenance.	PDF file / Documentation CD-ROM
Software User's Guide	Follow these instructions for Printing, Scanning, Network Scanning, PhotoCapture Center [®] , Remote Setup, PC-Fax, and using the Brother ControlCenter utility.	PDF file / Documentation CD-ROM
Network User's Guide	This Guide provides more advanced information for configuring the Ethernet and Wireless network connections. In addition, find information about network utilities, network printing, troubleshooting tips and supported network specifications.	PDF file / Documentation CD-ROM

Table of Contents

1	General setup	1
	Memory storage.....	1
	Volume Settings.....	1
	Ring Volume	1
	Beeper Volume.....	2
	Speaker Volume	2
	Automatic Daylight Saving Time.....	3
	Sleep Mode	3
	LCD screen.....	4
	Setting the backlight brightness.....	4
	Setting the Dim Timer for the backlight	4
	Setting the Wallpaper	4
	Mode Timer.....	5
2	Security features	6
	TX Lock	6
	Setting and changing the TX Lock password	6
	Turning TX Lock on/off	7
3	Sending a fax	8
	Additional sending options.....	8
	Sending faxes using multiple settings	8
	Contrast.....	8
	Changing fax resolution.....	9
	Setting your changes as the new default.....	9
	Restoring fax settings to the factory settings.....	9
	Additional sending operations.....	10
	Sending a fax manually	10
	Sending a fax at the end of a conversation	10
	Dual Access (Black & White only)	10
	Broadcasting (Black & White only)	10
	Real Time Transmission.....	12
	Overseas Mode	12
	Delayed Faxing (Black & White only)	12
	Delayed Batch Transmission (Black & White only)	13
	Checking and canceling waiting jobs.....	13
	Polling overview.....	14
	Polled Transmit (Black & White only)	14

4	Receiving a fax	15
	Memory Receive (Black & White only)	15
	Receiving faxes into memory when paper tray is empty	15
	Fax Forwarding.....	15
	Paging	16
	Fax Storage	16
	Printing a fax from the memory	17
	PC-Fax Receive (Windows® only).....	17
	Turning off Memory Receive operations.....	19
	Changing Memory Receive operations	19
	Remote Retrieval	20
	Setting a Remote Access Code.....	20
	Using your Remote Access Code.....	20
	Remote Fax commands	21
	Retrieving fax messages	22
	Changing your Fax Forwarding number	22
	Additional receiving operations.....	23
	Printing a reduced incoming fax	23
	Receiving a fax at the end of a conversation.....	23
	Polling overview.....	24
	Polling receive	24
5	Dialing and storing numbers	25
	Voice operations	25
	Tone or Pulse (Canada only).....	25
	Fax/Tel mode.....	25
	Caller ID.....	25
	Special line considerations	26
	Additional dialing operations.....	28
	Outgoing Call	28
	Caller ID history	28
	Dialing access codes and credit card numbers	29
	Additional ways to store numbers.....	30
	Storing Speed Dial numbers from Outgoing Calls.....	30
	Storing Speed Dial numbers from the Caller ID history	30
	Setting up groups for broadcasting.....	31
6	Printing reports	33
	Fax reports.....	33
	Transmission Verification Report.....	33
	Fax Journal (activity report)	33
	Reports	34
	How to print a report	34

7 Making copies 35

Copy settings	35
Stop copying	35
Changing copy quality	35
Enlarging or reducing the copied image	35
Making N in 1 copies or a poster (Page Layout)	37
Sorting copies using the ADF	38
Adjusting Density	38
Ink Save Mode	38
Book Copy	39
Watermark Copy	40
Setting your changes as the new default	41
Restoring all settings to the factory settings	41

8 PhotoCapture Center®: Printing photos from a memory card or USB Flash memory drive 42

PhotoCapture Center® operations	42
Memory cards, USB Flash memory drive and folder structures	42
Movie printing	43
Print Images	43
Print Index (Thumbnails)	43
Printing Photos	44
Print All Photos	45
Enhance Photos	45
Search by Date	48
Slide Show	48
Trimming	49
DPOF printing	49
PhotoCapture Center® print settings	50
Print Quality	50
Paper options	50
Adjusting Brightness, Contrast and Color	51
Cropping	52
Borderless printing	52
Print Date	52
Setting your changes as the new default	52
Restoring all settings to the factory settings	53
Scan to a memory card or USB Flash memory drive	53
Auto Crop	53
How to set a new default	54
How to reset to the factory settings	54

9	Printing photos from a camera	55
	Printing photos directly from a PictBridge camera	55
	PictBridge requirements	55
	Setting your digital camera	55
	Printing Images.....	56
	DPOF printing.....	56
	Printing photos directly from a digital camera (without PictBridge).....	57
	Printing Images.....	57
A	Routine maintenance	58
	Cleaning and checking the machine	58
	Cleaning the outside of the machine	58
	Cleaning the scanner.....	59
	Cleaning the machine's printer platen	59
	Cleaning the paper pick-up rollers.....	60
	Cleaning the print head	60
	Checking the print quality	61
	Checking the print alignment.....	62
	Checking the ink volume	62
	Packing and shipping the machine	63
B	Glossary	66
C	Index	70

Memory storage

Even if there is a power failure, you will not lose the settings you have chosen using the **Menu** key because they are stored permanently. Also, you will not lose your settings in the **FAX**, **COPY** and **PHOTO CAPTURE** mode key menus if you have chosen **Set New Default**. You may have to reset the date and time.

Volume Settings

Ring Volume

You can choose a range of ring volume levels, from **High** to **Off**.

While the machine is idle, press **⏸** **◀** or **▶** **⏸** to adjust the volume level. The LCD shows the current setting, and each key press will change the volume to the next level. The machine will keep the new setting until you change it.

You can also change the volume through the menu, by following the instructions below:

Setting the Ring Volume from the menu

- 1 Press **Menu**.
- 2 Press **▲** or **▼** to choose **General Setup**. Press **OK**.
- 3 Press **▲** or **▼** to choose **Volume**. Press **OK**.
- 4 Press **▲** or **▼** to choose **Ring**.
- 5 Press **◀** or **▶** to choose **Low**, **Med**, **High** or **Off**. Press **OK**.
- 6 Press **Stop/Exit**.

Beeper Volume

When the beeper is on, the machine will beep when you press a key, make a mistake, or after you send or receive a fax.

You can choose a range of beeper volume levels, from *High* to *Off*.

- 1 Press **Menu**.
- 2 Press **▲** or **▼** to choose *General Setup*. Press **OK**.
- 3 Press **▲** or **▼** to choose *Volume*. Press **OK**.
- 4 Press **▲** or **▼** to choose *Beeper*.
- 5 Press **◀** or **▶** to choose *Low*, *Med*, *High* or *Off*. Press **OK**.
- 6 Press **Stop/Exit**.

Speaker Volume

You can choose a range of speaker volume levels, from *High* to *Off*.

- 1 Press **Menu**.
- 2 Press **▲** or **▼** to choose *General Setup*. Press **OK**.
- 3 Press **▲** or **▼** to choose *Volume*. Press **OK**.
- 4 Press **▲** or **▼** to choose *Speaker*.
- 5 Press **◀** or **▶** to choose *Low*, *Med*, *High* or *Off*. Press **OK**.
- 6 Press **Stop/Exit**.

You can also adjust the speaker volume by pressing **Hook**.

- 1 Press **Hook**.
- 2 Press **▲** or **▼** to choose *Speaker*. Press **OK**.
- 3 Press **◀** or **▶** to choose *Low*, *Med*, *High* or *Off*.
- 4 Press **Hook**.

Automatic Daylight Saving Time

You can set the machine to change automatically for daylight saving time. It will reset itself forward one hour in the Spring and backward one hour in the Fall. Make sure you have set the correct date and time in the `Date&Time` setting.

The factory setting is `Off`, so you will have to turn on Automatic Daylight Saving Time as follows.

- 1 Press **Menu**.
- 2 Press **▲** or **▼** to choose `General Setup`. Press **OK**.
- 3 Press **▲** or **▼** to choose `Auto Daylight`.
- 4 Press **◀** or **▶** to choose `On` (or `Off`). Press **OK**.
- 5 Press **Stop/Exit**.

Sleep Mode

You can choose how long the machine must be idle (from 1 to 60 minutes) before it goes into sleep mode. The timer will restart if any operation is carried out on the machine.

- 1 Press **Menu**.
- 2 Press **▲** or **▼** to choose `General Setup`. Press **OK**.
- 3 Press **▲** or **▼** to choose `Sleep Mode`.
- 4 Press **◀** or **▶** to choose `1Min`, `2Mins`, `3Mins`, `5Mins`, `10Mins`, `30Mins` or `60Mins`. Press **OK**.
- 5 Press **Stop/Exit**.

LCD screen

Setting the backlight brightness

You can adjust the brightness of the LCD backlight. If you are having difficulty reading the LCD, try changing the brightness setting.

- 1 Press **Menu**.
- 2 Press **▲** or **▼** to choose `General Setup`. Press **OK**.
- 3 Press **▲** or **▼** to choose `LCD Settings`. Press **OK**.
- 4 Press **▲** or **▼** to choose `Backlight`.
- 5 Press **◀** or **▶** to choose `Light`, `Med` or `Dark`. Press **OK**.
- 6 Press **Stop/Exit**.

Setting the Dim Timer for the backlight

You can set how long the LCD backlight stays on after you go back to the Ready screen.

- 1 Press **Menu**.
- 2 Press **▲** or **▼** to choose `General Setup`. Press **OK**.
- 3 Press **▲** or **▼** to choose `LCD Settings`. Press **OK**.
- 4 Press **▲** or **▼** to choose `Dim Timer`.
- 5 Press **◀** or **▶** to choose `10Secs`, `20Secs`, `30Secs` or `Off`. Press **OK**.
- 6 Press **Stop/Exit**.

Setting the Wallpaper

You can change the wallpaper.

- 1 Press **Menu**.
- 2 Press **▲** or **▼** to choose `General Setup`. Press **OK**.
- 3 Press **▲** or **▼** to choose `LCD Settings`. Press **OK**.
- 4 Press **▲** or **▼** to choose `Wallpaper`. Press **OK**.
- 5 Press **▲** or **▼** to choose your wallpaper from the four available designs. Press **OK**.
- 6 Press **Stop/Exit**.

Mode Timer

The machine has four temporary mode keys on the control panel: **FAX**, **SCAN**, **COPY** and **PHOTO CAPTURE**. You can change the amount of time the machine takes after the last Scan, Copy or PhotoCapture operation before it returns to Fax mode. If you choose **Off**, the machine stays in the mode you used last.



- 1 Press **Menu**.
- 2 Press **▲** or **▼** to choose General Setup.
Press **OK**.
- 3 Press **▲** or **▼** to choose Mode Timer.
- 4 Press **◀** or **▶** to choose 0Sec, 30Secs, 1Min, 2Mins, 5Mins or Off.
Press **OK**.
- 5 Press **Stop/Exit**.

TX Lock

TX Lock lets you prevent unauthorized access to the machine. You will not be able to continue to schedule Delayed Faxes or Polling jobs. However, any pre-scheduled Delayed Faxes will be sent even if you turn on TX Lock, so they will not be lost.

While TX Lock is On, the following operations are available:

- Receiving faxes
- Fax Forwarding
(If Fax Forwarding was already On)
- Paging
(If Paging was already On)
- Remote retrieval
(If Fax Storage was already On)
- PC-Fax Receive
(If PC-Fax Receive was already On)

While TX Lock is On, the following operations are NOT available:

- Sending faxes
- Copying
- PC printing
- Scanning
- PhotoCapture
- Operation from the Control panel



Note

If you forget the TX Lock password, please call Brother Customer Service. (See *Brother numbers* on page i in the *Basic User's Guide*.)

Setting and changing the TX Lock password



Note

If you have already set the password, you will not need to set it again.

Setting the password

- 1 Press **Menu**.
- 2 Press **▲** or **▼** to choose **Fax**. Press **OK**.
- 3 Press **▲** or **▼** to choose **Miscellaneous**. Press **OK**.
- 4 Press **▲** or **▼** to choose **TX Lock**. Press **OK**.
- 5 Enter a 4-digit number for the password. Press **OK**.
- 6 When the LCD shows **Verify:**, re-enter the password. Press **OK**.
- 7 Press **Stop/Exit**.

Changing the password

- 1 Press **Menu**.
- 2 Press **▲** or **▼** to choose `Fax`. Press **OK**.
- 3 Press **▲** or **▼** to choose `Miscellaneous`. Press **OK**.
- 4 Press **▲** or **▼** to choose `TX Lock`. Press **OK**.
- 5 Press **▲** or **▼** to choose `Set Password`. Press **OK**.
- 6 Enter a 4-digit number for the current password. Press **OK**.
- 7 Enter a 4-digit number for a new password. Press **OK**.
- 8 When the LCD shows `Verify:`, re-enter the password. Press **OK**.
- 9 Press **Stop/Exit**.

Turning TX Lock on/off

Turning TX Lock on

- 1 Press **Menu**.
- 2 Press **▲** or **▼** to choose `Fax`. Press **OK**.
- 3 Press **▲** or **▼** to choose `Miscellaneous`. Press **OK**.
- 4 Press **▲** or **▼** to choose `TX Lock`. Press **OK**.
- 5 Press **▲** or **▼** to choose `Set TX Lock`. Press **OK**.
- 6 Enter the registered 4-digit password. Press **OK**.
The machine goes offline and the LCD shows `TX Lock Mode`.

Turning TX Lock off

- 1 Press **Menu**.
- 2 Enter the registered 4-digit password. Press **OK**.
TX Lock is automatically turned off.



Note

If you enter the wrong password, the LCD shows `Wrong Password` and stays offline. The machine will stay in TX Lock mode until the registered password is entered.

3

Sending a fax

Additional sending options

Sending faxes using multiple settings

When you send a fax you can choose any combination of these settings: resolution, contrast, scan size, etc.

- 1 Press  (FAX).
The LCD shows:

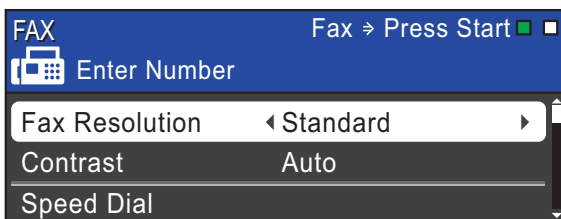

- 2 Press ▲ or ▼ to choose a setting you want to change.
- 3 Press ◀ or ▶ to choose an option.
Press **OK**.
- 4 Repeat steps 2 to 3 to change more settings.

Note

- Most settings are temporary and the machine returns to its default settings after you send a fax.
- You can save some of the settings you use most often by setting them as default. These settings will stay until you change them again. (See *Setting your changes as the new default* on page 9.)

Contrast

If your document is very light or very dark, you may want to change the contrast. For most documents the factory setting *Auto* can be used. It automatically chooses the suitable contrast for your document.

Choose *Light* when sending a light document. Choose *Dark* when sending a dark document.

- 1 Press  (FAX).
- 2 Press ▲ or ▼ to choose *Contrast*.
- 3 Press ◀ or ▶ to choose *Auto*, *Light* or *Dark*.
Press **OK**.

Note

Even if you choose *Light* or *Dark*, the machine will send the fax using the *Auto* setting in any of the following conditions:

- When you send a color fax.
- When you choose *Photo* as the Fax Resolution.

Changing fax resolution

The quality of a fax can be improved by changing the fax resolution.

- 1 Press  (**FAX**).
- 2 Press ▲ or ▼ to choose Fax Resolution.
- 3 Press ◀ or ▶ to choose the resolution you want. Press **OK**.



Note

You can choose four different resolution settings for black & white faxes and two for color faxes.

Black & White	
Standard	Suitable for most typed documents.
Fine	Good for small print and transmits a little slower than Standard resolution.
S.Fine	Good for small print or artwork and transmits slower than Fine resolution.
Photo	Use when the document has varying shades of gray or is a photograph. Photo has the slowest transmission.

Color	
Standard	Suitable for most typed documents.
Fine	Use when the document is a photograph. The transmission time is slower than Standard resolution.

If you choose *S.Fine* or *Photo* and then use the **Color Start** key to send a fax, the machine will send the fax using the *Fine* setting.

Setting your changes as the new default

You can save the fax settings for Fax Resolution, Contrast, Real Time TX and Glass ScanSize you use most often by setting them as default. These settings will stay until you change them again.

- 1 Press  (**FAX**).
- 2 Press ▲ or ▼ to choose the setting you want to change, and then press ◀ or ▶ to choose your new option. Press **OK**.

Repeat this step for each setting you want to change.

- 3 After changing the last setting, press ▲ or ▼ to choose Set New Default. Press **OK**.
- 4 Press **1** to choose Yes.
- 5 Press **Stop/Exit**.

Restoring fax settings to the factory settings

You can restore the fax settings Fax Resolution, Contrast, Real Time TX, and Glass ScanSize, that you have changed, to the factory settings.

- 1 Press  (**FAX**).
- 2 Press ▲ or ▼ to choose Factory Reset. Press **OK**.
- 3 Press **1** to choose Yes.
- 4 Press **Stop/Exit**.

Additional sending operations

Sending a fax manually

Manual transmission lets you hear the dialing, ringing and fax-receiving tones while sending a fax.



Note

To send a multiple page fax, use the ADF.

- 1 Press  (**FAX**).
- 2 Load your document.
- 3 To listen for a dial tone press **Hook** or pick up the handset of the external telephone.
- 4 Dial the fax number.
- 5 When you hear the fax tone, press **Black Start** or **Color Start**.
If you are using the scanner glass press **1** on the machine to send a fax.
- 6 If you picked up the handset of the external telephone, replace it.

Sending a fax at the end of a conversation

At the end of a conversation you can send a fax to the other party before you both hang up.

- 1 Ask the other party to wait for fax tones (beeps) and then to press the Start or Send key before hanging up.
- 2 Press  (**FAX**).
- 3 Load your document.

- 4 Press **Black Start** or **Color Start**.
 - If you are using the scanner glass, press **1** to send a fax.
- 5 Replace the handset of the external phone.

Dual Access (Black & White only)

You can dial a number and start scanning the fax into memory—even when the machine is sending from memory, receiving faxes or printing PC data. The LCD shows the new job number and available memory.

The number of pages you can scan into the memory will vary depending on the data that is printed on them.



Note

If the **Out of Memory** message appears while scanning a document, press **Stop/Exit** to cancel or **Black Start** to send the scanned pages.

Broadcasting (Black & White only)

Broadcasting is when the same fax message is automatically sent to more than one fax number. You can include Groups, Speed Dial numbers, and up to 50 manually dialed numbers in the same broadcast.

After the broadcast is finished, a Broadcast Report will be printed.

- 1 Press  (**FAX**).
- 2 Load your document.
- 3 Press **▲** or **▼** to choose **Broadcasting**. Press **OK**.

- 4 You can add numbers to the broadcast in the following ways:
- Press ▲ or ▼ to choose `Add Number` and enter a number using the dial pad.
Press **OK**.
 - Press ▲ or ▼ to choose `Speed Dial` and **OK**. Press ▲ or ▼ to choose `Alphabetic Order` or `Numeric Order` and **OK**. Press ▲ or ▼ to select a number and **OK**.
- 5 After you have entered all the fax numbers by repeating step 4, press ▲ or ▼ to choose `Complete`. Press **OK**.
- 6 Press **Black Start**.



Note

- If you did not use up any of the numbers for Groups, you can broadcast faxes to as many as 250 different numbers.
- The machine's available memory will vary depending on the types of jobs in the memory and the number of locations used for broadcasting. If you broadcast to the maximum number available, you will not be able to use dual access and delayed fax.
- If the `Out of Memory` message appears, press **Stop/Exit** to stop the job. If more than one page has been scanned, press **Black Start** to send the portion that is in the machine's memory.

Canceling a Broadcast in progress

- 1 Press **Menu**.
- 2 Press ▲ or ▼ to choose `Fax`. Press **OK**.
- 3 Press ▲ or ▼ to choose `Remaining Jobs`. Press **OK**.
The LCD will show the fax number being dialed and the Broadcast job number.
- 4 Press **OK**.
The LCD will ask you the following question:
`Cancel Job?`
`Yes → Press 1`
`No → Press 2`
- 5 Press **1** to cancel the fax number being dialed.
The LCD will then show the Broadcast job number.
- 6 Press **OK**.
The LCD will ask you the following question:
`Cancel Job?`
`Yes → Press 1`
`No → Press 2`
- 7 To cancel the Broadcast, press **1**.
- 8 Press **Stop/Exit**.

Real Time Transmission

When you are sending a fax, the machine will scan the document into the memory before sending it. Then, as soon as the telephone line is free, the machine will start dialing and sending.

Sometimes, you may want to send an important document immediately, without waiting for memory transmission. You can do this by turning on `Real Time TX`.

- 1 Press  (**FAX**).
- 2 Press **▲** or **▼** to choose `Real Time TX`.
- 3 Press **◀** or **▶** to choose `On` (or `Off`). Press **OK**.



Note

- If the memory is full and you are sending a black & white fax from the ADF, the machine will send the document in real time (even if `Real Time TX` is set to `Off`). Faxes from the scanner glass cannot be sent until you clear some of the memory.
- In Real Time Transmission, the automatic redial feature does not work when you are using the scanner glass.

Overseas Mode

If you are having difficulty sending a fax overseas due to possible interference on the telephone line, we recommend that you turn on the Overseas mode. After you send a fax using this feature, the feature will turn itself off.

- 1 Press  (**FAX**).
- 2 Load your document.
- 3 Press **▲** or **▼** to choose `Overseas Mode`.
- 4 Press **◀** or **▶** to choose `On` (or `Off`). Press **OK**.

Delayed Faxing (Black & White only)

You can store up to 50 faxes in the memory to be sent within 24 hours. These faxes will be sent at the time of day you enter in step 5.

- 1 Press  (**FAX**).
- 2 Load your document.
- 3 Press **▲** or **▼** to choose `Delayed Fax`.
- 4 Press **◀** or **▶** to choose `On`. Press **OK**.
- 5 Enter the time you want the fax to be sent (in 24-hour format).
(For example, enter 19:45 for 7:45 PM.) Press **OK**.



Note

- When you set `12h Clock` in the `Date&Time` setting, enter the time in 12-hour format.
- The number of pages you can scan into the memory depends on the amount of data that is printed on each page.

Delayed Batch Transmission (Black & White only)

Before sending the delayed faxes, your machine will help you economize by sorting all the faxes in the memory by destination and scheduled time. All delayed faxes that are scheduled to be sent at the same time to the same fax number will be sent as one fax to save transmission time.

- 1 Press  (**FAX**).
- 2 Press ▲ or ▼ to choose `Batch TX`.
- 3 Press ◀ or ▶ to choose `On`.
Press **OK**.
- 4 Press **Stop/Exit**.

Checking and canceling waiting jobs

You can check which jobs are still waiting in the memory to be sent and cancel a job. (If there are no jobs, the LCD shows `No Jobs Waiting`.)

- 1 Press **Menu**.
- 2 Press ▲ or ▼ to choose `Fax`.
Press **OK**.
- 3 Press ▲ or ▼ to choose
`Remaining Jobs`.
Press **OK**.
Any waiting jobs appear on the LCD.
- 4 Press ▲ or ▼ to scroll through the jobs and choose the job you want to cancel.
Press **OK**.

- 5 Do one of the following:
 - To cancel, press **1** to choose `Yes`.
If you want to cancel another job go to step 4.
 - To exit without canceling, press **2** to choose `No`.
- 6 Repeat steps 4 and 5 for each job you want to cancel.
- 7 When you are finished, press **Stop/Exit**.

Polling overview

Polling lets you set up your machine so other people can receive faxes from you, but they pay for the call. It also lets you call somebody else's fax machine and receive a fax from it, so you pay for the call. The polling feature needs to be set up on both machines for this to work. Not all fax machines support polling.

Polled Transmit (Black & White only)

Polled transmit lets you set up your machine to wait with a document so another fax machine can call and retrieve it.

The document will be stored and can be retrieved by any other fax machine until you delete it from the memory. (See *Checking and canceling waiting jobs* on page 13.)

Setup for polled transmit

- 1 Press  (FAX).
- 2 Load your document.
- 3 Press ▲ or ▼ to choose Polled TX.
- 4 Press ◀ or ▶ to choose On (or Off). Press **OK**.
- 5 Press ▲ or ▼ to choose any settings you want to change. Press **OK**.
After each setting is accepted, you can continue to change more settings.
- 6 Press **Black Start**.
- 7 If you are using the scanner glass, the LCD will prompt you to choose one of the options.
 - Press **1** to send another page. Go to step 8.
 - Press **2** or **Black Start** to send the document.

- 8 Place the next page on the scanner glass. Press **OK**. Repeat steps 7 and 8 for each additional page. Your machine will automatically send the fax.

Memory Receive (Black & White only)

You can only use one Memory Receive operation at a time:

- Fax Forwarding
- Paging
- Fax Storage
- PC-Fax Receive
- Off

You can change your selection at any time. If received faxes are still in the machine's memory when you change the Memory Receive operation, a question will appear on the LCD. (See *Changing Memory Receive operations* on page 19.)

Receiving faxes into memory when paper tray is empty

As soon as the paper tray becomes empty during fax reception, the LCD shows `No Paper Fed.` Put some paper in the paper tray. (See *Loading paper and other print media* in chapter 2 in the *Basic User's Guide*.)

The machine will carry on receiving the fax, with the remaining pages being stored in memory, if enough memory is available.

Further incoming faxes will also be stored in memory until the memory is full. When the memory is full the machine will stop automatically answering calls. To print the faxes, put fresh paper in the tray.

Fax Forwarding

When you choose Fax Forward, your machine stores the received fax in the memory. The machine will then dial the fax number you have programmed and forward the fax message.

- 1 Press **Menu**.
- 2 Press **▲** or **▼** to choose `Fax`. Press **OK**.
- 3 Press **▲** or **▼** to choose `Setup Receive`. Press **OK**.
- 4 Press **▲** or **▼** to choose `Memory Receive`. Press **OK**.
- 5 Press **▲** or **▼** to choose `Fax Forward`. Press **OK**.
- 6 Enter the forwarding number (up to 20 digits). Press **OK**.
- 7 Press **▲** or **▼** to choose `Backup Print:On` or `Backup Print:Off`. Press **OK**.

! IMPORTANT

- If you choose `Backup Print:On`, the machine will also print the fax at your machine so you will have a copy. This is a safety feature in case there is a power failure before the fax is forwarded or a problem at the receiving machine.
- When you receive a color fax, your machine prints the color fax at your machine but does not send the fax to the fax forwarding number you programmed.

- 8 Press **Stop/Exit**.

Paging

When you choose Paging, your machine dials the cell phone or pager number you have programmed. This activates your cell phone or pager so you will know that you have a fax message in the memory.

If you have set Paging, a backup copy of the received fax will automatically be printed at the machine.

- 1 Press **Menu**.
- 2 Press **▲** or **▼** to choose **Fax**. Press **OK**.
- 3 Press **▲** or **▼** to choose **Setup Receive**. Press **OK**.
- 4 Press **▲** or **▼** to choose **Memory Receive**. Press **OK**.
- 5 Press **▲** or **▼** to choose **Paging**. Press **OK**.
- 6 Enter your cell phone or pager number followed by **##** (up to 20 digits). Press **OK**.
Do not include the area code if it is the same as that of your machine.
For example, press:
1 8 0 0 5 5 5 1 2 3 4 ##

- 7 Do one of the following:

- If you are programming your cell phone number and do not need to enter a PIN, press **OK**.
- If your pager needs a PIN, enter the PIN, press **#**, press **Redial/Pause**, and then enter your fax number followed by **##**.

Press **OK**.

For example, press:

1 2 3 4 5 # Redial/Pause 1 8 0 0 5 5 5 6 7 8 9 ##

- If your pager does not need a PIN, press:

Redial/Pause, and then enter your fax number followed by **##**.

Press **OK**.

For example, press:

Redial/Pause 1 8 0 0 5 5 5 6 7 8 9 ##

- 8 Press **Stop/Exit**.



Note

You cannot change a paging number or PIN remotely.

Fax Storage

If you choose Fax Storage, your machine stores the received fax in the memory. You will be able to retrieve fax messages from another location using the remote retrieval commands.

If you have set Fax Storage, a backup copy will automatically be printed at the machine.

- 1 Press **Menu**.
- 2 Press **▲** or **▼** to choose **Fax**. Press **OK**.

- 3 Press ▲ or ▼ to choose `Setup Receive`. Press **OK**.
- 4 Press ▲ or ▼ to choose `Memory Receive`. Press **OK**.
- 5 Press ▲ or ▼ to choose `Fax Storage`. Press **OK**.
- 6 Press **Stop/Exit**.

**Note**

Color faxes cannot be stored in the memory. When you receive a color fax your machine prints the color fax at your machine.

Printing a fax from the memory

If you have chosen `Paging` or `Fax Storage`, you can still print a fax from the memory when you are at your machine. (See *Memory Receive (Black & White only)* on page 15.)

- 1 Press **Menu**.
- 2 Press ▲ or ▼ to choose `Fax`. Press **OK**.
- 3 Press ▲ or ▼ to choose `Print Fax`. Press **OK**.
- 4 Press **Black Start**.
- 5 Press **Stop/Exit**.

**Note**

When you print a fax from the memory, the fax data will be erased.

PC-Fax Receive (Windows® only)

If you turn on the PC-Fax Receive feature your machine will store received faxes in memory and send them to your PC automatically. You can then use your PC to view and store these faxes.

Even if you have turned off your PC (at night or on the weekend, for example), your machine will receive and store your faxes in its memory. The number of received faxes that are stored in the memory will appear at the bottom left side of the LCD.

When you start your PC and the PC-FAX Receiving software runs, your machine transfers your faxes to your PC automatically.

To transfer the received faxes to your PC you must have the PC-FAX Receiving software running on your PC. (For details, see *PC-FAX receiving* in the *Software User's Guide*.)

If you choose `Backup Print:On` the machine will also print the fax.

- 1 Press **Menu**.
- 2 Press ▲ or ▼ to choose `Fax`. Press **OK**.
- 3 Press ▲ or ▼ to choose `Setup Receive`. Press **OK**.
- 4 Press ▲ or ▼ to choose `Memory Receive`. Press **OK**.
- 5 Press ▲ or ▼ to choose `PC Fax Receive`. Press **OK**.
- 6 The LCD shows the message `Run PC-Fax on your computer`. Press **OK**.
- 7 Press ▲ or ▼ to choose `<USB>` or the PC you want to receive faxes. Press **OK**.

8 Press ▲ or ▼ to choose
Backup Print:On or
Backup Print:Off.
Press **OK**.

9 Press **Stop/Exit**.



Note

- PC-Fax Receive is not supported in the Mac OS.
- Before you can set up PC-Fax Receive you must install the MFL-Pro Suite software on your PC. Make sure your PC is connected and turned on. (For details see *PC-FAX receiving* in the *Software User's Guide*.)
- If you get an error message and the machine cannot print the faxes in memory, you can use this setting to transfer your faxes to your PC. (For details, see *Transferring your faxes or Fax Journal report* in *appendix B* in the *Basic User's Guide*.)
- When you receive a color fax, your machine prints the color fax at your machine but does not send the fax to your PC.

6 The LCD shows the message
Run PC-Fax on your computer.
Press **OK**.

7 Press ▲ or ▼ to choose *Change*.
Press **OK**.

8 Press ▲ or ▼ to choose <USB>, or the PC
you want to receive faxes.
Press **OK**.

9 Press ▲ or ▼ to choose
Backup Print:On or
Backup Print:Off.
Press **OK**.

10 Press **Stop/Exit**.

Changing the destination PC

1 Press **Menu**.

2 Press ▲ or ▼ to choose *Fax*.
Press **OK**.

3 Press ▲ or ▼ to choose
Setup Receive.
Press **OK**.

4 Press ▲ or ▼ to choose
Memory Receive.
Press **OK**.

5 Press ▲ or ▼ to choose
PC Fax Receive.
Press **OK**.

Turning off Memory Receive operations

- 1 Press **Menu**.
- 2 Press **▲** or **▼** to choose **Fax**. Press **OK**.
- 3 Press **▲** or **▼** to choose **Setup Receive**. Press **OK**.
- 4 Press **▲** or **▼** to choose **Memory Receive**. Press **OK**.
- 5 Press **▲** or **▼** to choose **Off**. Press **OK**.
- 6 Press **Stop/Exit**.



Note

The LCD will give you more options if there are received faxes still in the machine's memory. (See *Changing Memory Receive operations* on page 19.)

Changing Memory Receive operations

If received faxes remain in your machine's memory when you change the Memory Receive Operations, the LCD will ask you one of the following questions:

■ Erase All Fax?

Yes → Press 1

No → Press 2

■ Print All Fax?

Yes → Press 1

No → Press 2

- If you press **1**, faxes in the memory will be erased or printed before the setting changes. If a backup copy has already been printed it will not be printed again.
- If you press **2**, faxes in the memory will not be erased or printed and the setting will be unchanged.

If received faxes are left in the machine's memory when you change to **PC Fax Receive** from another option [Fax Forward, Paging or Fax Storage], press **▲** or **▼** to choose the PC.

The LCD will ask you the following question:

■ Send Fax to PC?

Yes → Press 1

No → Press 2

- If you press **1**, faxes in the memory will be sent to your PC before the setting changes. You will be asked if you want to turn on Backup Print. (For details, see *PC-Fax Receive (Windows® only)* on page 17.)
- If you press **2**, faxes in the memory will not be erased or transferred to your PC and the setting will be unchanged.

Remote Retrieval

You can call your machine from any touch-tone telephone or fax machine and then use the remote access code and remote commands to retrieve fax messages.

Setting a Remote Access Code

The remote access code lets you access the remote retrieval features when you are away from your machine. Before you can use the remote access and retrieval features, you have to set up your own code. The factory default code is the inactive code (---*).

- 1 Press **Menu**.
- 2 Press **▲** or **▼** to choose **Fax**. Press **OK**.
- 3 Press **▲** or **▼** to choose **Remote Access**.
- 4 Enter a three-digit code using numbers **0-9**, *****, or **#**. Press **OK**. (The preset “*” cannot be changed.)



Note

Do not use the same code as your Fax Receive Code (* 5 1) or Telephone Answer Code (# 5 1). (See *Using external and extension telephones* in chapter 6 in the *Basic User's Guide*.)

- 5 Press **Stop/Exit**.



Note

You can change your code at any time by entering a new one. If you want to make your code inactive, press **Clear** in step 4 to restore the inactive setting (---*) and press **OK**.

Using your Remote Access Code

- 1 Dial your fax number from a touch-tone telephone or another fax machine.
- 2 When your machine answers, enter your remote access code (3 digits followed by *) at once.
- 3 The machine signals if it has received messages:
 - 1 long beep — Fax messages
 - No beeps — No messages
- 4 When the machine gives two short beeps, enter a command. The machine will hang up if you wait longer than 30 seconds to enter a command. The machine will beep three times if you enter an invalid command.
- 5 Press **9 0** to stop Remote Access when you have finished.
- 6 Hang up.



Note

If your machine is set to **Manual** mode and you want to use the remote retrieval features, wait for about 100 seconds after it starts ringing, and then enter the remote access code within 30 seconds.

Remote Fax commands

Follow the commands below to access features when you are away from the machine. When you call the machine and enter your remote access code (3 digits followed by *), the system will give two short beeps and you must enter a remote command.

Remote commands		Operation details
95	Change the Fax Forwarding, Paging or Fax Storage settings	
	1 OFF	You can choose OFF after you have retrieved or erased all your messages.
	2 Fax Forwarding	One long beep means the change is accepted. If you hear three short beeps, you cannot make a change because something has not been set up (for example, a Fax Forwarding or Paging number has not been registered).
	3 Paging	
	4 Fax Forwarding number	
6 Fax Storage	You can register your Fax Forwarding number by entering 4. (See <i>Changing your Fax Forwarding number</i> on page 22.) Once you have registered the number, Fax Forwarding will work.	
96	Retrieve a fax	
	2 Retrieve all faxes	Enter the number of a remote fax machine to receive stored fax messages. (See <i>Retrieving fax messages</i> on page 22.)
	3 Erase faxes from the memory	If you hear one long beep, fax messages have been erased from the memory.
97	Check the receiving status	
	1 Fax	You can check whether your machine has received any faxes. If yes, you will hear one long beep. If no, you will hear three short beeps.
98	Change the Receive Mode	
	1 External TAD	If you hear one long beep, your change has been accepted.
	2 Fax/Tel	
	3 Fax Only	
90	Exit	Pressing 90 allows you to exit remote retrieval. Wait for the long beep, then replace the handset.

Retrieving fax messages

You can call your machine from any touch-tone telephone and have your fax messages sent to a machine. Before you use this feature, you have to turn on Fax Storage.

- 1 Dial your fax number.
- 2 When your machine answers, enter your remote access code (3 digits followed by *) at once. If you hear one long beep, you have messages.
- 3 When you hear two short beeps, press **9 6 2**.
- 4 Wait for a long beep, and then use the dial pad to enter the number of the remote fax machine where you want your fax messages sent, followed by **# #** (up to 20 digits).



Note

You cannot use * and # as dial numbers. However, press # if you want to create a pause.

- 5 Hang up after you hear your machine beep. Your machine will call the other fax machine, which will then print your fax messages.

Changing your Fax Forwarding number

You can change the default setting of your fax forwarding number from another touch-tone telephone or fax machine.

- 1 Dial your fax number.
- 2 When your machine answers, enter your remote access code (3 digits followed by *) at once. If you hear one long beep, you have messages.
- 3 When you hear two short beeps, press **9 5 4**.
- 4 Wait for the long beep, enter the new number (up to 20 digits) of the remote fax machine you want your fax messages forwarded to using the dial pad, then enter **# #**.



Note

You cannot use * and # as dial numbers. However, press # if you want to create a pause.

- 5 Press **9 0** to stop Remote Access when you have finished.
- 6 Hang up after you hear your machine beep.

Additional receiving operations

Printing a reduced incoming fax

If you choose **On**, the machine automatically reduces each page of an incoming fax to fit on one page of Letter, Legal or A4 size paper. The machine calculates the reduction ratio by using the page size of the fax and your Paper Size setting. (See *Paper Size* in *chapter 2* in the *Basic User's Guide*.)

- 1 Press **Menu**.
- 2 Press **▲** or **▼** to choose **Fax**. Press **OK**.
- 3 Press **▲** or **▼** to choose **Setup Receive**. Press **OK**.
- 4 Press **▲** or **▼** to choose **Auto Reduction**.
- 5 Press **◀** or **▶** to choose **On** (or **Off**). Press **OK**.
- 6 Press **Stop/Exit**.

Receiving a fax at the end of a conversation

At the end of a conversation, you can ask the other party to fax you information before you both hang up.

- 1 Ask the other party to place the document in their machine and to press the **Start** or **Send** key.
- 2 When you hear the other machine's CNG tones (slowly repeating beeps), press **Black Start** or **Color Start**.
- 3 Press **2** to receive the fax.
- 4 Replace the handset of the external telephone.

Polling overview

Polling lets you set up your machine so other people can receive faxes from you, but they pay for the call. It also lets you call somebody else's fax machine and receive a fax from it, so you pay for the call. The polling feature needs to be set up on both machines for this to work. Not all fax machines support polling.

Polling receive

Polling receive lets you call another fax machine to receive a fax.

Setup to receive polling

- 1 Press  (FAX).
- 2 Press ▲ or ▼ to choose `Polling RX`.
- 3 Press ◀ or ▶ to choose `On (or Off)`. Press **OK**.
- 4 Enter the fax number you are polling.
- 5 Press **Black Start** or **Color Start**. The LCD shows `Dialing`.

Sequential polling (Black & White only)

Sequential polling lets you request documents from several fax machines in one operation. Afterwards, a Sequential Polling Report will be printed.

- 1 Press  (FAX).
- 2 Press ▲ or ▼ to choose `Polling RX`.
- 3 Press ◀ or ▶ to choose `On (or Off)`. Press **OK**.
- 4 Press ▲ or ▼ to choose `Broadcasting`. Press **OK**.

- 5 Do one of the following:
 - Press ▲ or ▼ to choose `Add Number` and enter the number using a dial pad. Press **OK**.
 - Press ▲ or ▼ to choose `Speed Dial` and **OK**. Press ▲ or ▼ to choose `Alphabetic Order` or `Numeric Order` and **OK**. Press ▲ or ▼ to select a number and **OK**.
- 6 After you have entered all the fax numbers by repeating step 5, press ▲ or ▼ to choose `Complete`. Press **OK**.
- 7 Press **Black Start**. The machine polls each number or Group number in turn for a document.

Press **Stop/Exit** while the machine is dialing to cancel the polling process.

To cancel all sequential polling receive jobs, see *Checking and canceling waiting jobs* on page 13.

Voice operations

Voice calls can be made either with an external telephone, by dialing manually, or by using Quick Dial numbers.

Tone or Pulse (Canada only)

If you have a Pulse dialing service, but need to send tone signals (for example, for telephone banking), follow the instructions below:

- 1 Pick up the handset of an external telephone or press **Hook**.
- 2 Press **#** on the machine's control panel. Any digits dialed after this will send tone signals.

When you hang up, the machine will return to the Pulse dialing service.

Fax/Tel mode

When the machine is in Fax/Tel mode, it will use the F/T Ring (pseudo/double-ringing) to alert you to pick up a voice call.

If you are at the extension telephone, you'll need to lift the handset during the F/T Ring and then press **# 5 1** between the pseudo/double-rings. If no one is on the line, or if someone wants to send you a fax, send the call back to the machine by pressing *** 5 1**.

If you are at the machine, lift the external telephone's handset, and then press **Hook** to answer.

Caller ID

The Caller ID feature lets you use the Caller ID subscriber service offered by many local telephone companies. Call your telephone company for details. This service shows the telephone number, or name if it is available, of your caller as the line rings.

After a few rings, the LCD shows the telephone number of your caller (and name, if available). Once you answer a call, the Caller ID information disappears from the LCD, but the call information stays stored in the Caller ID memory.

You can view the list or choose one of these numbers to fax to, add to Speed Dial, or delete from the history. (See *Caller ID history* on page 28.)

- You can see the first 18 characters of the number (or name).
- The # `Unavailable` message means the call originated outside your Caller ID service area.
- The `Private Call` message means the caller has intentionally blocked transmission of information.

You can print a list of the Caller ID information received by your machine. (See *How to print a report* on page 34.)



Note

- This feature may not be available in certain areas of the USA and Canada.
- The Caller ID service varies with different carriers. Call your local telephone company to find out about the kind of service available in your area.

Setting up your area code (USA only)

When returning calls from the Caller ID history your machine will automatically dial “1” plus the area code for all calls. If your local dialing plan requires that the “1” not be used for calls within your area code enter your area code in this setting. With the area code setting, calls returned from the Caller ID history to your area code will be dialed using 10 digits (area code + 7-digit number). If your dialing plan does not follow the standard 1 + area code + 7-digit number dialing system for calling outside your area code, you may experience problems returning calls automatically from the Caller ID history. If this is not the procedure followed by your dialing plan, you will not be able to return calls automatically.

- 1 Press **Menu**.
- 2 Press **▲** or **▼** to choose `Fax`. Press **OK**.
- 3 Press **▲** or **▼** to choose `Miscellaneous`. Press **OK**.
- 4 Press **▲** or **▼** to choose `Caller ID`. Press **OK**.
- 5 Use the dial pad to enter your area code. Press **OK**.
- 6 Press **Stop/Exit**.

Special line considerations

Roll-over telephone lines

A roll-over telephone system is a group of two or more separate telephone lines that pass incoming calls to each other if they are busy. The calls are usually passed down or “rolled over” to the next available telephone line in a preset order.

Your machine can work in a roll-over system as long as it is the last number in the sequence, so the call cannot roll away. Do not put the machine on any of the other numbers; when the other lines are busy and a second fax call is received, the fax call will be sent to a line that does not have a fax machine. **Your machine will work best on a dedicated line.**

Two-line telephone system

A two-line telephone system is nothing more than two separate telephone numbers on the same wall outlet. The two telephone numbers can be on separate jacks (RJ11) or mixed into one jack (RJ14). Your machine must be plugged into an RJ11 jack. RJ11 and RJ14 jacks may be equal in size and appearance and both may contain four wires (black, red, green, yellow). To test the type of jack, plug in a two-line telephone and see if it can access both lines. If it can, you must separate the line for your machine. (See *Easy Receive* in *chapter 5* in the *Basic User’s Guide*.)

Converting telephone wall outlets

There are three ways to convert to an RJ11 jack. The first two ways may require help from the telephone company. You can change the wall outlets from one RJ14 jack to two RJ11 jacks. Or you can have an RJ11 wall outlet installed and slave or jump one of the telephone numbers to it.

The third way is the easiest: Buy a triplex adapter. You can plug a triplex adapter into an RJ14 outlet. It separates the wires into two separate RJ11 jacks (Line 1, Line 2) and a third RJ14 jack (Lines 1 and 2). If your machine is on Line 1, plug the machine into L1 of the triplex adapter. If your machine is on Line 2, plug it into L2 of the triple adapter.

Triplex Adapter

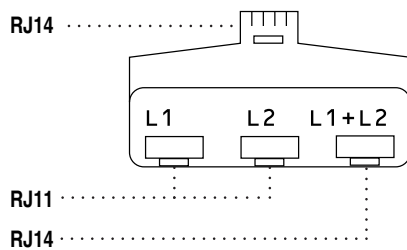

Installing machine, external two-line TAD and two-line telephone

When you are installing an external two-line telephone answering device (TAD) and a two-line telephone, your machine must be isolated on one line at both the wall jack and at the TAD. The most common connection is to put the machine on Line 2, which is explained in the following steps. The back of the two-line TAD must have two telephone jacks: one labeled L1 or L1/L2, and the other labeled L2. You will need at least three telephone line cords, the one that came with your machine and two for your external two-line TAD. You will need a fourth line cord if you add a two-line telephone.

- 1 Put the two-line TAD and the two-line telephone next to your machine.
- 2 Plug one end of the telephone line cord for your machine into the L2 jack of the triplex adapter. Plug the other end into the LINE jack on the back of the machine.
- 3 Plug one end of the first telephone line cord for your TAD into the L1 jack of the triplex adapter. Plug the other end into the L1 or L1/L2 jack of the two-line TAD.

- 4 Plug one end of the second telephone line cord for your TAD into the L2 jack of the two-line TAD. Plug the other end into the EXT. jack on the left side of the machine.

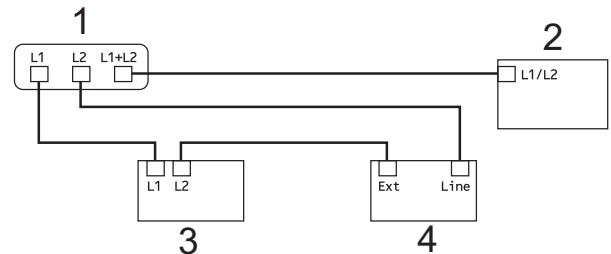

- 1 **Triplex Adapter**
- 2 **Two Line Telephone**
- 3 **External Two Line TAD**
- 4 **Machine**

You can keep two-line telephones on other wall outlets as always. There are two ways to add a two-line telephone to the machine's wall outlet. You can plug the telephone line cord from the two-line telephone into the L1+L2 jack of the triplex adapter. Or you can plug the two-line telephone into the TEL jack of the two-line TAD.

Additional dialing operations

Outgoing Call

The last 30 numbers you sent a fax to will be stored in the outgoing call history. You can choose one of these numbers to fax to, add to Speed Dial, or delete from the history.

- 1 Press **Redial/Pause**.
You can also choose *Outgoing Call* by pressing  (**FAX**).
- 2 Press **▲** or **▼** to choose the number you want.
Press **OK**.
- 3 Do one of the following:
 - To send a fax, press **▲** or **▼** to choose *Send a fax*.
Press **OK**.
Press **Black Start** or **Color Start**.
 - If you want to store the number, press **▲** or **▼** to choose *Add SpeedDial*.
Press **OK**.
(See *Storing Speed Dial numbers from Outgoing Calls* on page 30.)
 - Press **▲** or **▼** to choose *Delete*.
Press **OK**.
Press **1** to confirm.
- 4 Press **Stop/Exit**.

Caller ID history

This feature requires the Caller ID subscriber service offered by many local telephone companies. (See *Caller ID* on page 25.)

The number, or name if available, from the last 30 faxes and telephone calls you received will be stored in the Caller ID history. You can view the list or choose one of these numbers to fax to, add to Speed Dial or delete from the history. When the thirty-first call comes into the machine, it replaces information about the first call.



Note

If you are not a Caller ID subscriber, Caller ID history only allows you to view and delete the dates of calls.

- 1 Press **Redial/Pause** and press *****.
You can also choose *Caller ID hist.* by pressing  (**FAX**).
- 2 Press **▲** or **▼** to choose the number you want.
Press **OK**.
- 3 Do one of the following:
 - To send a fax, press **▲** or **▼** to choose *Send a fax*.
Press **OK**.
Press **Black Start** or **Color Start**.
 - If you want to store the number, press **▲** or **▼** to choose *Add SpeedDial*.
Press **OK**.
(See *Storing Speed Dial numbers from Outgoing Calls* on page 30.)
 - Press **▲** or **▼** to choose *Delete*.
Press **OK**.
Press **1** to confirm.
- 4 Press **Stop/Exit**.

**Note**

- (USA only) If you redial from the Caller ID history outside your area code, you must set up your AREA CODE in advance. (See *Setting up your area code (USA only)* on page 26.)
- You can print the Caller ID List. (See *How to print a report* on page 34.)

Dialing access codes and credit card numbers

Sometimes, you may want to choose from several long distance carriers when you send a fax. Rates may vary depending on the time and destination. To take advantage of low rates, you can store the access codes of long-distance carriers and credit card numbers as Speed Dial numbers. You can store these long dialing sequences by dividing them and setting them up as separate Speed Dial numbers in any combination. You can even include manual dialing using the dial pad. (See *Storing Speed Dial numbers* in chapter 7 in the *Basic User's Guide*.)

For example, you might have stored "555" on Speed Dial: 03 and "7000" on Speed Dial: 02. You can use them both to dial "555-7000" if you press the following keys:

- 1 Press  (**Speed Dial**).
- 2 Press **▲** or **▼** to choose *Search*. Press **OK**.
- 3 Enter **03**.
- 4 Press **▲** or **▼** to choose *Speed Dial*. Press **OK**.

**Note**

If you stored 2 numbers in one Speed Dial location, you will be asked which number you want to send to.

5

Press **▲** or **▼** to choose *Search*. Press **OK**.

6

Enter **02**.

7

Press **Black Start** or **Color Start**. You will dial "555-7000".

To temporarily change a number, you can substitute part of the number with manual dialing using the dial pad. For example, to change the number to 555-7001 you could press  (**Speed Dial**), choose *Search*, press **03** and then press **7001** using the dial pad.

**Note**

If you must wait for another dial tone or signal at any point in the dialing sequence, create a pause in the number by pressing **Redial/Pause**. Each key press adds a 3.5-second delay.

Additional ways to store numbers

Storing Speed Dial numbers from Outgoing Calls

You can also store Speed Dial numbers from the Outgoing Call history.

- 1 Press **Redial/Pause**.
You can also choose *Outgoing Call* by pressing  (**FAX**).
- 2 Press **▲** or **▼** to choose the name or number you want to store.
Press **OK**.
- 3 Press **▲** or **▼** to choose *Add SpeedDial*.
Press **OK**.
- 4 Press **▲** or **▼** to choose the 2-digit Speed Dial location where you want to store the number.
Press **OK**.
- 5 Do one of the following:
 - Enter the name (up to 16 characters) using the dial pad.
Press **OK**.
(To help you enter letters, see *Entering Text* in *appendix C* in the *Basic User's Guide*.)
 - To store the number without a name, press **OK**.
- 6 Press **OK** to confirm the fax or telephone number.
- 7 Do one of the following:
 - Enter a second fax or telephone number (up to 20 digits).
Press **OK**.
 - If you do not want to store a second number, press **OK**.

- 8 Press **▲** or **▼** to choose *Complete*.
Press **OK**.

- 9 Press **Stop/Exit**.

Storing Speed Dial numbers from the Caller ID history

If you have the Caller ID subscriber service from your telephone company you can also store Speed Dial numbers from incoming calls in the Caller ID History. (See *Caller ID* on page 25.)

- 1 Press **Redial/Pause** and press *****.
You can also choose *Caller ID hist.* by pressing  (**FAX**).
- 2 Press **▲** or **▼** to choose the number you want to store.
Press **OK**.
- 3 Press **▲** or **▼** to choose *Add SpeedDial*.
Press **OK**.
- 4 Press **▲** or **▼** to choose the 2-digit Speed Dial location where you want to store the number.
Press **OK**.
- 5 Do one of the following:
 - If you want to store the displayed name, press **OK**.
 - Enter the name (up to 16 characters) using the dial pad.
Press **OK**.
(To help you enter letters, see *Entering Text* in *appendix C* in the *Basic User's Guide*.)
 - To store the number without a name, press **OK**.
- 6 Press **OK** to confirm the fax or telephone number.

- 7 Do one of the following:
 - Enter a second fax or telephone number (up to 20 digits).
Press **OK**.
 - If you do not want to store a second number, press **OK**.
- 8 Press **▲** or **▼** to choose *Complete*. Press **OK**.
- 9 Press **Stop/Exit**.

Setting up groups for broadcasting

Groups, which can be stored in a Speed Dial location, allow you to send the same fax message to many fax numbers by pressing only  (**Speed Dial**), *Search*, **OK**, the two-digit location and **Black Start**.

First, you'll need to store each fax number in a Speed Dial location. Then you can include them as numbers in the Group. Each Group uses up a Speed Dial location. You can have up to six Groups, or you can assign up to 198 numbers in a large Group.

(See *Broadcasting (Black & White only)* on page 10 and *Storing Speed Dial numbers* in *chapter 7* in the *Basic User's Guide*.)

- 1 Press  (**Speed Dial**).
- 2 Press **▲** or **▼** to choose *Setup Groups*. Press **OK**.
- 3 Press **▲** or **▼** to choose *GROUP1*, *GROUP2*, *GROUP3*, *GROUP4*, *GROUP5* or *GROUP6* for the Group name where you will store the fax numbers. Press **OK**.
- 4 Press **▲** or **▼** to choose the 2-digit Speed Dial location where you want to store the Group. Press **OK**.







- 5 If you want to change the Group name, press **▲** or **▼** to choose *Change Group Name* and press **OK**. Then enter the new Group name and press **OK**.
- 6 Press **▲** or **▼** to choose *Add Number*. Press **OK**.
- 7 To add numbers to the group, press **▲** or **▼** to choose *Alphabetic Order* or *Numeric Order* and **OK**. Press **▲** or **▼** to select a number and **OK**.
- 8 Do one of the following:
 - To add another number to the group, repeat steps 6 to 7.
 - If you are finished adding numbers to the group, press **▲** or **▼** to choose *Complete*. Press **OK**.
- 9 Do one of the following:
 - To store another Group for broadcasting, repeat steps 3 to 8.
 - To finish storing Groups for broadcasting, press **Stop/Exit**.



Note

You can print a list of all the Speed Dial numbers. Group numbers will be marked in the *GROUP* column. (See *Reports* on page 34.)



Changing a Group name



- 1 Press  (Speed Dial).
- 2 Press  or  to choose Setup Groups. Press **OK**.
- 3 Press  or  to choose the Group name you want to change. Press **OK**.
- 4 Press  or  to choose Change Group Name. Press **OK**.









Note

How to change the stored name or number:









If you want to change a character, press  or  to position the cursor under the character you want to change, and then press **Clear**. Re-enter the character.

- 5 Enter the new name (up to 16 characters) using the dial pad. Press **OK**.
(See *Entering Text* in appendix C in the *Basic User's Guide*. For example, type NEW CLIENTS.)
- 6 Press  or  to choose Complete. Press **OK**.
- 7 Press **Stop/Exit**.

Deleting a Group

- 1 Press  (Speed Dial).
- 2 Press  or  to choose Setup Groups. Press **OK**.
- 3 Press  or  to choose the Group you want to delete. Press **OK**.
- 4 Press  or  to choose Delete. Press **OK**. Press **1** to confirm.
- 5 Press **Stop/Exit**.

Deleting a number from a Group

- 1 Press  (Speed Dial).
- 2 Press  or  to choose Setup Groups. Press **OK**.
- 3 Press  or  to choose the Group you want to change. Press **OK**.
- 4 Press  or  to choose the number you want to delete. Press **OK**. Press **1** to confirm.
- 5 Press  or  to choose Complete. Press **OK**.
- 6 Press **Stop/Exit**.

Fax reports

You need to set up the Transmission Verification Report and Journal Period using the **Menu** keys.

Transmission Verification Report

You can use the Transmission Verification Report as proof that you sent a fax. (For details about how to set up the type of report you want, see *Transmission Verification Report* in chapter 4 in the *Basic User's Guide*.)

Fax Journal (activity report)

You can set the machine to print a journal at specific intervals (every 50 faxes, 6, 12 or 24 hours, 2 or 7 days). If you set the interval to **Off**, you can still print the report by following the steps in *How to print a report* on page 34. The factory setting is **Every 50 Faxes**.

- 1 Press **Menu**.
- 2 Press **▲** or **▼** to choose **Fax**. Press **OK**.
- 3 Press **▲** or **▼** to choose **Report Setting**. Press **OK**.
- 4 Press **▲** or **▼** to choose **Journal Period**.

- 5 Press **◀** or **▶** to choose an interval. Press **OK**.
If you choose **Every 50 Faxes**, go to step 8.

- **6, 12, 24 hours, 2 or 7 days**

The machine will print the report at the chosen time and then erase all jobs from its memory. If the machine's memory becomes full with 200 jobs before the time you chose has passed, the machine will print the Journal early and then erase all jobs from the memory. If you want an extra report before it is due to print, you can print it without erasing the jobs from the memory.

- **Every 50 Faxes**

The machine will print the Journal when the machine has stored 50 jobs.

- 6 Enter the time to start printing in 24-hour format. Press **OK**.
(For example: enter 19:45 for 7:45 PM.)



Note

When you set **12h Clock** in the **Date&Time** setting, enter the time in 12-hour format.

- 7 If you choose **Every 7 Days**, the LCD will ask you to choose the first day for the 7-day countdown.
- 8 Press **Stop/Exit**.

Reports

The following reports are available:

- **Transmission**
Prints a Transmission Verification Report for your last transmission.
- **Help List**
A help list showing how to program your machine.
- **Quick Dial**
Lists names and numbers stored in the Speed Dial memory, in alphabetical or numerical order.
- **Fax Journal**
Lists information about the last incoming and outgoing faxes.
(TX: Transmit.) (RX: Receive.)
- **User Settings**
Lists your settings.
- **Network Config**
Lists your Network settings.
- **WLAN Report**
Prints the result of the WLAN connection.
- **Caller ID hist.**
Lists the available Caller ID information about the last 30 received faxes and telephone calls.

How to print a report

- 1 Press **Menu**.
- 2 Press **▲** or **▼** to choose **Print Reports**. Press **OK**.
- 3 Press **▲** or **▼** to choose the report you want. Press **OK**.
- 4 (Quick Dial only) Press **▲** or **▼** to choose **Alphabetic Order** or **Numeric Order**. Press **OK**.
- 5 Press **Black Start**.
- 6 Press **Stop/Exit**.

Copy settings

You can change the copy settings temporarily for the next copy.

These settings are temporary, and the machine returns to its default settings 1 minute after copying, unless you have set the Mode Timer to 30 seconds or less. (See *Mode Timer* on page 5.)

To change a setting, press **COPY** and then press ▲ or ▼ to scroll through the copy settings. When the setting you want is highlighted, press **OK**.

When you are finished choosing settings, press **Black Start** or **Color Start**.



Note

You can save some of the settings that you use most often by setting them as default. These settings will stay until you change them again. (See *Setting your changes as the new default* on page 41.)

Stop copying

To stop copying, press **Stop/Exit**.

Changing copy quality

You can choose from a range of quality. The factory setting is *Normal*.

■ Fast

Fast copy speed and lowest amount of ink used. Use to save time printing documents to be proof-read, large documents or many copies.

■ Normal

Normal is the recommended mode for ordinary printouts. This produces good copy quality with good copy speed.

■ Best

Use Best mode to copy precise images such as photographs. This provides the highest resolution and slowest speed.

- 1 Press  (**COPY**).
- 2 Load your document.
- 3 Enter the number of copies you want.
- 4 Press ▲ or ▼ to choose *Quality*.
- 5 Press ◀ or ▶ to choose *Fast*, *Normal* or *Best*. Press **OK**.
- 6 If you do not want to change additional settings, press **Black Start** or **Color Start**.

Enlarging or reducing the copied image

You can choose an enlargement or reduction ratio. If you choose *Fit to Page*, your machine will adjust the size automatically to the paper size you set.

- 1 Press  (**COPY**).
- 2 Load your document.
- 3 Enter the number of copies you want.
- 4 Press ▲ or ▼ to choose Enlarge/Reduce.
- 5 Press ◀ or ▶ to choose 100%, Enlarge, Reduce, Fit to Page or Custom(25-400%).
- 6 Do one of the following:
 - If you chose Enlarge or Reduce, press **OK** and press ◀ or ▶ to choose the enlargement or reduction ratio you want. Press **OK**.
 - If you chose Custom(25-400%), press **OK** and then enter an enlargement or reduction ratio from 25% to 400%. Press **OK**.
 - If you chose 100% or Fit to Page, go to step 7.

198% 4"x6"→A4
186% 4"x6"→LTR
104% EXE→LTR
100%
97% LTR→A4
93% A4→LTR
85% LTR→EXE
83% LGL→A4
78% LGL→LTR
46% LTR→4"x6"
Fit to Page
Custom(25-400%)

- 7 If you do not want to change additional settings, press **Black Start** or **Color Start**.



Note

- Page Layout is not available with Enlarge/Reduce.
- Page Layout, Book Copy, Sort and Watermark Copy are not available with Fit to Page.
- Fit to Page does not work properly when the document on the scanner glass is skewed more than 3 degrees. Using the document guidelines on the left and top, place your document in the upper left hand corner, with the document face down on the scanner glass.
- Fit to Page is not available when using the ADF.

Making N in 1 copies or a poster (Page Layout)

The N in 1 copy feature can help you save paper by letting you copy two or four pages onto one printed page.

You can also produce a poster. When you use the poster feature your machine divides your document into sections, then enlarges the sections so you can assemble them into a poster. If you want to print a poster, use the scanner glass.

! IMPORTANT

- Make sure the paper size is set to Letter, A4 or Executive.
- Poster copy is not available for Executive size paper.
- You cannot use the Enlarge/Reduce setting with the N in 1 and Poster features.
- If you are producing multiple color copies, N in 1 copy is not available.
- (P) means Portrait and (L) means Landscape.
- You can only make one poster copy at a time.

Note

Watermark Copy, Book Copy, Sort, Ink Save Mode and Enlarge/Reduce are not available with Page Layout.

- 1 Press  (COPY).
- 2 Load your document.
- 3 Enter the number of copies you want.
- 4 Press ▲ or ▼ to choose Page Layout.

- 5 Press ◀ or ▶ to choose Off (1 in 1), 2 in 1 (P), 2 in 1 (L), 4 in 1 (P), 4 in 1 (L) or Poster (3 x 3). Press **OK**.

- 6 If you do not want to change additional settings, press **Black Start** or **Color Start** to scan the page. If you placed the document in the ADF or are making a poster, the machine scans the pages and starts printing.

If you are using the scanner glass, go to step 7.

- 7 After the machine scans the page, press **1** to scan the next page.
- 8 Place the next page on the scanner glass. Press **OK**.
- 9 Repeat steps 7 and 8 for each page of the layout.
- 10 After all the pages have been scanned, press **2** to finish.



Note

If you have chosen photo paper as the Paper Type for N in 1 copies, the machine will print the images as if plain paper had been chosen.

Place the document face down in the direction shown below:

■ 2 in 1 (P)



■ 2 in 1 (L)

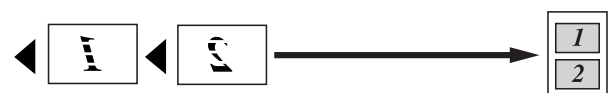

■ **4 in 1 (P)**



■ **4 in 1 (L)**



■ **Poster (3 x 3)**

You can make a poster size copy of a photograph.

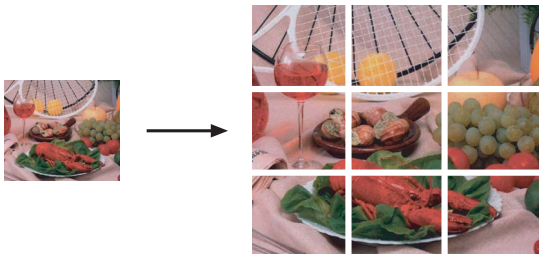

Sorting copies using the ADF

You can sort multiple copies. Pages will be stacked in the order 321, 321, 321, and so on.

- 1 Press (**COPY**).
- 2 Load your document.
- 3 Enter the number of copies you want.
- 4 Press ▲ or ▼ to choose *Stack/Sort*.
- 5 Press ◀ or ▶ to choose *Sort*. Press **OK**.
- 6 If you do not want to change additional settings, press **Black Start** or **Color Start**.



Note

Fit to Page, *Page Layout* and *Book Copy* are not available with *Sort*.

Adjusting Density

You can adjust the copy density to make copies darker or lighter.

- 1 Press (**COPY**).
- 2 Load your document.
- 3 Enter the number of copies you want.
- 4 Press ▲ or ▼ to choose *Density*.
- 5 Press ▶ to make the copy darker or ◀ to make the copy lighter. Press **OK**.
- 6 If you do not want to change additional settings, press **Black Start** or **Color Start**.

Ink Save Mode

Ink Save Mode can help you save some ink. Your machine detects the edges of the image and prints the outline of the image.

The amount of ink saved will vary depending on the document.

Ink Save Mode: Off

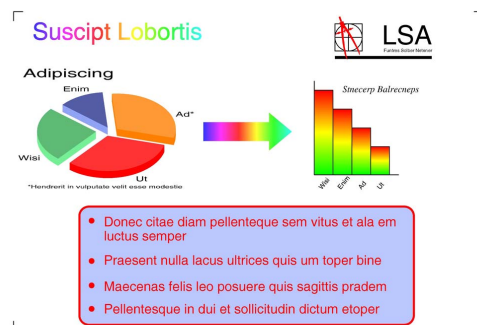

Ink Save Mode: On

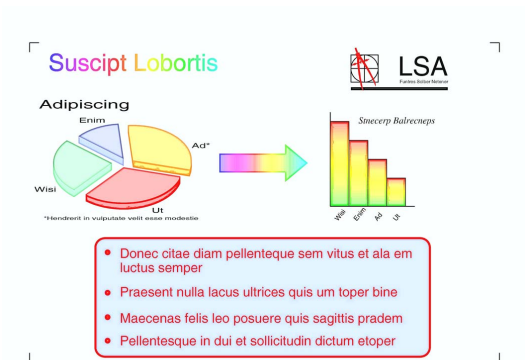

- 1 Press  (**COPY**).
- 2 Load your document.
- 3 Enter the number of copies you want.
- 4 Press ▲ or ▼ to choose Ink Save Mode.
- 5 Press ◀ or ▶ to choose On (or Off). Press **OK**.
- 6 If you do not want to change any additional settings, press **Black Start** or **Color Start**.



Note

- Watermark Copy, Book Copy and Page Layout are not available with Ink Save Mode.
- Ink Save Mode may make your printouts look different from your original document.
- The Ink Save Mode feature is supported by technology from Reallusion,



Book Copy

Book copy corrects dark borders and skew when copying from the scanner glass. Your machine can correct the data automatically or you can make specific corrections.

- 1 Press  (**COPY**).
- 2 Load your document.
- 3 Enter the number of copies you want.
- 4 Press ▲ or ▼ to choose Book Copy.
- 5 Do one of the following:
 - If you want to correct the data yourself, press ◀ or ▶ to choose On (Preview).
Press **Black Start** or **Color Start** and go to step 6.
 - If you want the machine to correct the data automatically, press ◀ or ▶ to choose On and go to step 7.
- 6 Adjust the skewed data by using # or *. Remove the shadows by using ▲ or ▼.
- 7 If you are finished making corrections, press **Black Start** or **Color Start**.



Note

- Page Layout, Sort, Ink Save Mode, Fit to Page and Watermark Copy are not available with Book Copy.
- The Book Copy feature is supported by technology from Reallusion, Inc.



Watermark Copy

You can place a logo or text into your document as a Watermark. You can select one of the template watermarks, data from your media cards or USB Flash memory drive, or scanned data.

Note

- Fit to Page, Page Layout, Ink Save Mode and Book Copy are not available with Watermark Copy.
- The Watermark Copy feature is supported by technology from Reallusion,



Using a template

- 1 Press  (COPY).
- 2 Load your document.
- 3 Enter the number of copies you want.
- 4 Press ▲ or ▼ to choose Watermark Copy. Press **OK**.
- 5 Press ◀ or ▶ to choose On.
- 6 Press ▲ or ▼ to choose Current Setting. Press **OK**.
- 7 Press ▲ or ▼ to choose Template. Press **OK**.
- 8 Change the settings from the options displayed on the LCD if required.
- 9 If you do not want to change additional settings, press **Black Start** or **Color Start**.

Using media card or a USB Flash memory drive

- 1 Press  (COPY).
- 2 Load your document.
- 3 Enter the number of copies you want.
- 4 Press ▲ or ▼ to choose Watermark Copy. Press **OK**.
- 5 Press ◀ or ▶ to choose On.
- 6 Press ▲ or ▼ to choose Current Setting. Press **OK**.
- 7 Insert a media card or USB Flash memory drive. Press ▲ or ▼ to choose Media.
- 8 Press **OK** and then press ◀ or ▶ to choose the data you want to use for the watermark.
- 9 Press **OK** and change any additional settings from the options shown on the LCD.
- 10 If you do not want to change additional settings, press **Black Start** or **Color Start**.

! IMPORTANT

DO NOT take out the memory card or USB Flash memory drive while **PHOTO CAPTURE** is blinking to avoid damaging the card, USB Flash memory drive, or the data stored on them.

Using a scanned paper document as your watermark

- 1 Press  (**COPY**).
- 2 Enter the number of copies you want.
- 3 Press ▲ or ▼ to choose **Watermark Copy**. Press **OK**.
- 4 Press ◀ or ▶ to choose **On**.
- 5 Press ▲ or ▼ to choose **Current Setting**. Press **OK**.
- 6 Press ▲ or ▼ to choose **Scan**. Press **OK**, and place the page that you want to use as a watermark on the scanner glass.
- 7 Press **Black Start** or **Color Start**.
- 8 Take out the watermark document you scanned and load the document you want to copy.
- 9 Press ◀ or ▶ to change the **Transparency** of the watermark. Press **OK**.
- 10 If you do not want to change any additional settings, press **Black Start** or **Color Start**.



Note

You cannot enlarge or reduce the scanned watermark.

Setting your changes as the new default

You can save the copy settings for **Quality**, **Enlarge/Reduce**, **Density**, **Ink Save Mode** and **Page Layout** that you use most often by setting them as the default settings. These settings will stay until you change them again.

- 1 Press  (**COPY**).
- 2 Press ▲ or ▼ and ◀ or ▶ to choose your new setting. Press **OK**. Repeat this step for each setting you want to change.
- 3 After changing the last setting, press ▲ or ▼ to choose **Set New Default**. Press **OK**.
- 4 Press **1** to choose **Yes**.
- 5 Press **Stop/Exit**.

Restoring all settings to the factory settings

You can restore the copy settings

Quality, **Enlarge/Reduce**, **Density**, **Ink Save Mode**, and **Page Layout**, that you have changed, to the factory settings.

- 1 Press  (**COPY**).
- 2 Press ▲ or ▼ to choose **Factory Reset**. Press **OK**.
- 3 Press **1** to choose **Yes**.
- 4 Press **Stop/Exit**.

PhotoCapture Center[®]: Printing photos from a memory card or USB Flash memory drive

PhotoCapture Center[®] operations

Memory cards, USB Flash memory drive and folder structures

Your machine is designed to be compatible with modern digital camera image files, memory cards and USB Flash memory drive; however, please read the points below to avoid errors:

- The image file extension must be .JPG (other image file extensions like .JPEG, .TIF, .GIF and so on will not be recognized).
- Direct PhotoCapture Center[®] printing must be performed separately from PhotoCapture Center[®] operations using the PC. (Simultaneous operation is not available.)
- The machine can read up to 999 files on a memory card or USB Flash memory drive.
- The DPOF file on the memory cards must be in a valid DPOF format. (See *DPOF printing* on page 49.)

Please be aware of the following:

- When printing an index or image, the PhotoCapture Center[®] will print all valid images, even if one or more images have been corrupted. Corrupted images will not be printed.
- (memory card users)
Your machine is designed to read memory cards that have been formatted by a digital camera.
When a digital camera formats a memory card it creates a special folder into which it copies image data. If you need to modify the image data stored on a memory card with your PC, we recommend that you do not modify the folder structure created by the digital camera. When saving new or modified image files to the memory card we also recommend you use the same folder your digital camera uses. If the data is not saved to the same folder, the machine may not be able to read the file or print the image.
- (USB Flash memory drive users)
This machine supports USB Flash memory drives that have been formatted by Windows[®].

Movie printing

You can print images from movie files that are stored on a memory card or USB Flash memory drive.

A movie file is automatically divided into 9 parts by movie recording times and is placed in 3 lines, then you can see and print the scenes that have been automatically divided.

Note

- You cannot choose a particular movie scene.
 - You can use AVI or MOV movie file formats. However, if an AVI file size is 1 GB or more (the shooting time is about 30 minutes) or a MOV file size is 2 GB or more (the shooting time is about 60 minutes), these files cannot be printed.
-

Print Images

Print Index (Thumbnails)

The PhotoCapture Center® assigns numbers for images (such as No.1, No.2, No.3, and so on).



→ NO.1
DEI.JPG 01.01.2009
100KB

The PhotoCapture Center® does not recognize any other numbers or file names that your digital camera or computer has used to identify the pictures. You can print a thumbnail page. This will show all the pictures on the memory card or USB Flash memory drive.

Note

Only file names that are 8 characters or less will be printed correctly on the index sheet.

- 1 Make sure you have put the memory card or USB Flash memory drive in the proper slot.
Press  (**PHOTO CAPTURE**).
- 2 Press ▲ or ▼ to choose `Print Index`. Press **OK**.

- 3 Press ▲ or ▼ to choose **Layout Format**. Press ◀ or ▶ to choose **6 Images/Line** or **5 Images/Line**. Press **OK**.

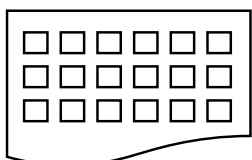

6 Images/Line

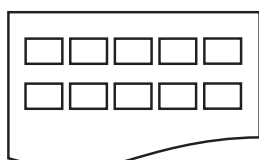

5 Images/Line

Print time for 5 Images/Line will be slower than 6 Images/Line, but the quality is better.

- 4 Do one of the following:
- Press ▲ or ▼ to choose **Paper Type**, and press ◀ or ▶ to choose the type of paper you are using, **Plain Paper**, **Inkjet Paper**, **Brother BP71**, **Brother BP61** or **Other Glossy**. Press **OK**.
 - Press ▲ or ▼ to choose **Paper Size** and press ◀ or ▶ to choose the paper size you are using, **Letter** or **A4**. Press **OK**.
 - If you do not want to change the paper settings, go to step 5.
- 5 Press **Color Start** to print.

Printing Photos

Before you can print an individual image, you have to know the image number.

- 1 Make sure you have put the memory card or USB Flash memory drive in the proper slot.
Press  (**PHOTO CAPTURE**).
- 2 Print the Index. (See *Print Index (Thumbnails)* on page 43.)

- 3 Press ▲ or ▼ to choose **Print Photos**. Press **OK**.
- 4 Enter the image number that you want to print from the Index page (Thumbnails). Press **OK**.
- 5 Repeat step 4 until you have entered all the image numbers that you want to print.



Note

- You can enter multiple numbers at one time by using the * key for a comma or the # key for a hyphen. For example, Enter **1, *, 3, *, 6** to print images No.1, No.3 and No.6. Enter **1, #, 5** to print images No.1 to No.5.
- You can enter up to 12 characters (including commas) for the image numbers you want to print.

- 6 After you have chosen all the image numbers, press **OK** again.
- 7 Enter the number of copies you want using the dial pad.
- 8 Do one of the following:
- Change the print settings. (See *PhotoCapture Center® print settings* on page 50.)
 - If you do not want to change any settings, press **Color Start** to print.

Print All Photos

You can print all the photos on your memory card or USB Flash memory drive.

- 1 Make sure you have put the memory card or USB Flash memory drive in the proper slot.
Press  (**PHOTO CAPTURE**).
- 2 Press ▲ or ▼ to choose *Print All Photos*.
Press **OK**.
- 3 Enter the number of copies you want using the dial pad.
- 4 Do one of the following:
 - Change the print settings. (See *PhotoCapture Center[®] print settings* on page 50.)
 - If you do not want to change any settings, press **Color Start** to print.

Enhance Photos

You can edit and add effects to your photos and view them on the LCD before printing.



Note

- After adding each effect, you can enlarge the view of the image by pressing *. To go back to the original size, press * again.
- The *Enhance Photos* feature is supported by technology from Reallusion,

Inc. 
REALLUSION

Auto Correct

Auto Correct is available for most photos. The machine decides the suitable effect for your photo.

- 1 Make sure you have put the memory card or USB Flash memory drive in the proper slot.
Press  (**PHOTO CAPTURE**).
- 2 Press ▲ or ▼ to choose *Enhance Photos*.
Press **OK**.
- 3 Press ◀ or ▶ to choose your photo or picture.
Press **OK**.
- 4 Press ▲ or ▼ to choose *Auto Correct*.
Press **OK**.



Note

If *Remove Red-Eye* appears on the LCD, press # to attempt to remove red-eye from your photo.

- 5 Press **OK** and enter the number of copies you want using the dial pad.
- 6 Do one of the following:
 - Press **OK** and change the print settings. (See *PhotoCapture Center[®] print settings* on page 50.)
 - If you do not want to change any settings, press **Color Start** to print.

Enhance Skin-Tone

Enhance Skin-Tone is best used for adjusting portrait photographs. It detects human skin color in your photos and adjusts the image.

- 1 Make sure you have put the memory card or USB Flash memory drive in the proper slot.
Press  (**PHOTO CAPTURE**).
- 2 Press ▲ or ▼ to choose *Enhance Photos*.
Press **OK**.
- 3 Press ◀ or ▶ to choose your photo or picture.
Press **OK**.
- 4 Press ▲ or ▼ to choose *Enhance Skin*.
Press **OK**.



Note

You can also adjust the effect level manually, by pressing ▲ or ▼.

- 5 Press **OK** and enter the number of copies you want using the dial pad.
- 6 Do one of the following:
 - Press **OK** and change the print settings. (See *PhotoCapture Center*[®] print settings on page 50.)
 - If you do not want to change any settings, press **Color Start** to print.

Enhance Scenery

Enhance Scenery is best used for adjusting landscape photographs. It highlights green and blue areas in your photo, so that the landscape looks more sharp and vivid.

- 1 Make sure you have put the memory card or USB Flash memory drive in the proper slot.
Press  (**PHOTO CAPTURE**).

- 2 Press ▲ or ▼ to choose *Enhance Photos*.
Press **OK**.
- 3 Press ◀ or ▶ to choose your photo or picture.
Press **OK**.
- 4 Press ▲ or ▼ to choose *Enhance Scenery*.
Press **OK**.



Note

You can also adjust the effect level manually, by pressing ▲ or ▼.

- 5 Press **OK** and enter the number of copies you want using the dial pad.
- 6 Do one of the following:
 - Press **OK** and change the print settings. (See *PhotoCapture Center*[®] print settings on page 50.)
 - If you do not want to change any settings, press **Color Start** to print.

Remove Red-Eye

The machine detects eyes in your photos and will attempt to remove red-eye from your photo.



Note

There are some cases when red-eye may not be removed.

- When the face is too small in the image.
- When the face is turning too far up, down, left or right.

- 1 Make sure you have put the memory card or USB Flash memory drive in the proper slot.
Press  (**PHOTO CAPTURE**).

- 2 Press ▲ or ▼ to choose *Enhance Photos*. Press **OK**.
- 3 Press ◀ or ▶ to choose your photo or picture. Press **OK**.
- 4 Press ▲ or ▼ to choose *Remove Red-Eye*. Press **OK**.
 - When *Remove Red-Eye* is successful, the photo with the effect is shown. The adjusted part is shown in a red frame.
 - When *Remove Red-Eye* is unsuccessful, *Unable to Detect.* is shown. Press **OK**.



Note

Press # to try *Remove Red-Eye* once again.

- 5 Press **OK** and enter the number of copies you want using the dial pad.
- 6 Do one of the following:
 - Press **OK** and change the print settings. (See *PhotoCapture Center*® print settings on page 50.)
 - If you do not want to change any settings, press **Color Start** to print.

Monochrome

You can convert your photo to black & white.

- 1 Make sure you have put the memory card or USB Flash memory drive in the proper slot. Press  (**PHOTO CAPTURE**).
- 2 Press ▲ or ▼ to choose *Enhance Photos*. Press **OK**.

- 3 Press ◀ or ▶ to choose your photo or picture. Press **OK**.
- 4 Press ▲ or ▼ to choose *Monochrome*. Press **OK**.
- 5 Press **OK** and enter the number of copies you want using the dial pad.
- 6 Do one of the following:
 - Press **OK** and change the print settings. (See *PhotoCapture Center*® print settings on page 50.)
 - If you do not want to change any settings, press **Color Start** to print.

Sepia

You can convert the color of your photo to sepia.

- 1 Make sure you have put the memory card or USB Flash memory drive in the proper slot. Press  (**PHOTO CAPTURE**).
- 2 Press ▲ or ▼ to choose *Enhance Photos*. Press **OK**.
- 3 Press ◀ or ▶ to choose your photo or picture. Press **OK**.
- 4 Press ▲ or ▼ to choose *Sepia*. Press **OK**.
- 5 Press **OK**. Then enter the number of copies you want using the dial pad.
- 6 Do one of the following:
 - Press **OK** and change the print settings. (See *PhotoCapture Center*® print settings on page 50.)
 - If you do not want to change any settings, press **Color Start** to print.

Search by Date

You can find your photos based on date.

- 1 Make sure you have put the memory card or USB Flash memory drive in the proper slot.
Press  (**PHOTO CAPTURE**).
- 2 Press ▲ or ▼ to choose *Search by Date*.
Press **OK**.
- 3 Press ▲ or ▼ to choose the date that you want to search from.
Press **OK**.
- 4 Press ◀ or ▶ to choose your photo or picture.



Note

You can view photos with other dates by pressing ◀ or ▶ continuously. Press ◀ to view an older photo and ▶ to view a more recent photo.

- 5 Enter the number of copies you want using the dial pad.
- 6 Repeat steps 4 and 5 until you have chosen all your photos.
- 7 After you have chosen all your photos, do one of the following:
 - Press **OK** and change the print settings. (See *PhotoCapture Center*[®] *print settings* on page 50.)
 - If you do not want to change any settings, press **Color Start** to print.

Slide Show

You can view all your photos on the LCD using *Slide Show*. You can also choose a photo during the operation.

- 1 Make sure you have put the memory card or USB Flash memory drive in the proper slot.
Press  (**PHOTO CAPTURE**).
- 2 Press ▲ or ▼ to choose *Slide Show*.
Press **OK**.
- 3 Press **Stop/Exit** to finish *Slide Show*.

Printing a photo during a Slide Show

- 1 Press **OK** to stop at one image while *Slide Show* is operating.
- 2 Enter the number of copies you want using the dial pad.
- 3 Do one of the following:
 - Press **OK** and change the print settings. (See *PhotoCapture Center*[®] *print settings* on page 50.)
 - If you do not want to change any settings, press **Color Start** to print.

Trimming

You can trim your photo and print a part of the image.



Note

If your photo is very small or an irregular shape you may not be able to trim the photo. The LCD will show

Image Too Small. or

Image Too Long.

- 1 Make sure you have put the memory card or USB Flash memory drive in the proper slot.
Press  (**PHOTO CAPTURE**).
- 2 Press **▲** or **▼** to choose `Trimming`. Press **OK**.
- 3 Press **◀** or **▶** to choose your photo or picture. Press **OK**.
- 4 Adjust the red frame around your photo. The part inside of the red frame will be printed.
 - Press ***** or **#** to enlarge or reduce the frame size.
 - Press each arrow key to move the position of the frame.
 - Press **0** to rotate the frame.
 - Press **OK** when you have finished adjusting the frame setting.
- 5 Enter the number of copies you want using the dial pad.
- 6 Do one of the following:
 - Press **OK** and change the print settings. (See *PhotoCapture Center[®] print settings* on page 50.)
 - If you do not want to change any settings, press **Color Start** to print.

DPOF printing

DPOF stands for Digital Print Order Format.

Major digital camera manufacturers (Canon Inc., Eastman Kodak Company, FUJIFILM Corporation, Panasonic Corporation and Sony Corporation) created this standard to make it easier to print images from a digital camera.

If your digital camera supports DPOF printing, you will be able to choose on the digital camera display the images and number of copies you want to print.

When a memory card (Memory Stick[™], Memory Stick PRO[™], Memory Stick Duo[™], Memory Stick PRO Duo[™] SD or SDHC) containing DPOF information is put into your machine, you can print the chosen image easily.

- 1 Make sure you have put the memory card in the proper slot.
Press  (**PHOTO CAPTURE**). The machine will ask you if you want to use DPOF settings.
- 2 Press **1** to choose `Yes`.
- 3 Do one of the following:
 - Change the print settings. (See *PhotoCapture Center[®] print settings* on page 50.)
 - If you do not want to change any settings, press **Color Start** to print.



Note

- An Invalid DPOF File error can occur if the print order that was created on the camera has been corrupted. Delete and recreate the print order using your camera to correct this problem. For instructions on how to delete or recreate the print order, refer to your camera manufacturer's support Web site or accompanying documentation.
- You cannot print a movie file using DPOF.

PhotoCapture Center[®] print settings

You can change the print settings temporarily for the next printing.

These settings are temporary, and the machine returns to its default settings 3 minutes after printing, unless you have set the Mode Timer to 2 minutes or less. (See *Mode Timer* on page 5.)



Note

You can save the print settings you use most often by setting them as the default. (See *Setting your changes as the new default* on page 52.)

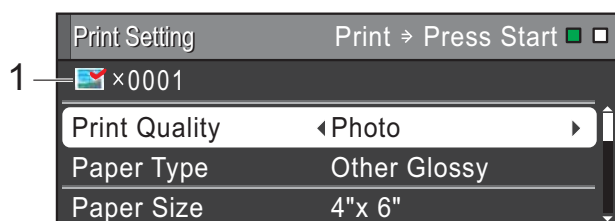

1 No. of prints

(For View Photo(s), Search by Date, Slide Show)

You can see the total number of photos that will be printed.

(For Print All Photos, Print Photos, Enhance Photos, Trimming)

You can see the number of copies of each photo that will be printed.

(For DPOF printing)

This does not appear.

Print Quality

- 1 Press ▲ or ▼ to choose Print Quality.
- 2 Press ◀ or ▶ to choose Normal or Photo. Press **OK**.
- 3 If you do not want to change additional settings, press **Color Start** to print.

Paper options

Paper Type

- 1 Press ▲ or ▼ to choose Paper Type.
- 2 Press ◀ or ▶ to choose the paper type you are using, Plain Paper, Inkjet Paper, Brother BP71, Brother BP61 or Other Glossy. Press **OK**.
- 3 If you do not want to change additional settings, press **Color Start** to print.

Paper and print size

- 1 Press ▲ or ▼ to choose Paper Size.
- 2 Press ◀ or ▶ to choose the paper size you are using, 4" x 6", 5" x 7", Letter or A4. Press **OK**.
- 3 If you chose Letter or A4, press ▼. Then press ◀ or ▶ to choose the Print Size. Press **OK**.

Example: Printed Position for Letter paper		
1 3" x 4" 	2 3.5" x 5" 	3 4" x 6"
4 5" x 7" 	5 6" x 8" 	6 Max. Size

- 4 If you do not want to change additional settings, press **Color Start** to print.

Adjusting Brightness, Contrast and Color

Brightness

- 1 Press ▲ or ▼ to choose `Brightness`.
- 2 Press ◀ to make a darker print or press ▶ to make a lighter print. Press **OK**.
- 3 If you do not want to change additional settings, press **Color Start** to print.

Contrast

You can choose the contrast setting. Increasing the contrast will make an image look sharper and more vivid.

- 1 Press ▲ or ▼ to choose `Contrast`.
- 2 Press ▶ to increase the contrast or press ◀ to decrease the contrast. Press **OK**.
- 3 If you do not want to change additional settings, press **Color Start** to print.

Color Enhancement (True2Life®)

You can turn on the color enhancement (True2Life®) feature to print more vivid images. Printing time will be slower.

- 1 Press ▲ or ▼ to choose `True2Life`. Press **OK**.
- 2 Do one of the following:
 - If you want to customize the `White Balance`, `Sharpness` or `Color Density`, press ◀ or ▶ to choose `On`, and then go to step ③.
 - If you do not want to customize, press ◀ or ▶ to choose `Off`. Press **OK** and then go to step ⑥.

- 3 Press ▲ or ▼ to choose `White Balance`, `Sharpness` or `Color Density`.
- 4 Press ◀ or ▶ to adjust the degree of the setting. Press **OK**.
- 5 Do one of the following:
 - If you want to customize another color enhancement, press ▲ or ▼ to choose another option.
 - If you want to change other settings, press ▲ or ▼ to choose `Exit`, and then press **OK**.
- 6 If you do not want to change additional settings, press **Color Start** to print.



Note

• **White Balance**

This setting adjusts the hue of the white areas of an image. Lighting, camera settings and other influences will affect the appearance of white. The white areas of a picture may be slightly pink, yellow or some other color. By using this setting, you can correct that effect and bring the white areas back to pure white.

• **Sharpness**

This setting enhances the detail of an image, similar to adjusting the fine focus on a camera. If the image is not in true focus and you cannot see the fine details of the picture, then adjust the sharpness.

• **Color Density**

This setting adjusts the total amount of color in the image. You can increase or decrease the amount of color in an image to improve a washed out or weak picture.

Cropping

If your photo is too long or wide to fit the available space on your chosen layout, part of the image will automatically be cropped.

The factory setting is *On*. If you want to print the whole image, turn this setting to *Off*. When you set *Cropping* to *Off*, also set *Borderless* to *Off*. (See *Borderless printing* on page 52.)

- 1 Press ▲ or ▼ to choose *Cropping*.
- 2 Press ◀ or ▶ to choose *Off* (or *On*). Press **OK**.
- 3 If you do not want to change additional settings, press **Color Start** to print.

Cropping: On

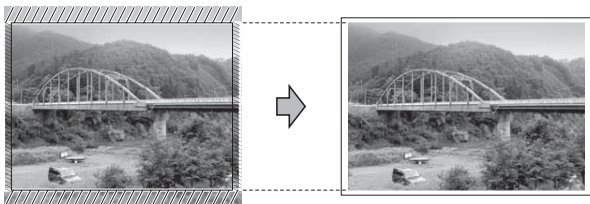

Cropping: Off

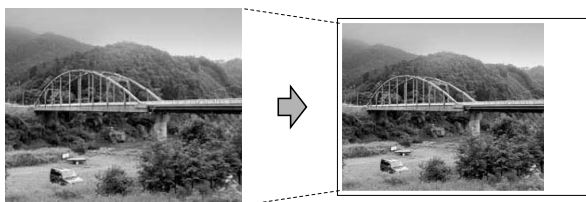

Borderless printing

This feature expands the printable area to the edges of the paper. Printing time will be slightly slower.

- 1 Press ▲ or ▼ to choose *Borderless*.
- 2 Press ◀ or ▶ to choose *Off* (or *On*). Press **OK**.
- 3 If you do not want to change additional settings, press **Color Start** to print.

Print Date

You can print the date if it is already in the data on your photo. The date will be printed on the lower right corner. If the data doesn't have the date information, you cannot use this function.

- 1 Press ▲ or ▼ to choose *Print Date*.
- 2 Press ◀ or ▶ to choose *On* (or *Off*). Press **OK**.
- 3 If you do not want to change additional settings, press **Color Start** to print.



Note

- The DPOF setting on your camera must be turned off to use the *Print Date* feature.
- This function is not available for AVI or MOV movie file formats.

Setting your changes as the new default

You can save the print settings you use most often by setting them as the default settings. These settings will stay until you change them again.

- 1 Press ▲ or ▼ and ◀ or ▶ to choose your new setting. Press **OK**. Repeat this step for each setting you want to change.
- 2 After changing the last setting, press ▲ or ▼ to choose *Set New Default*. Press **OK**.
- 3 Press **1** to choose *Yes*.
- 4 Press **Stop/Exit**.

Restoring all settings to the factory settings

You can restore the PhotoCapture settings

Print Quality, Paper Type, Paper Size, Brightness, Contrast, Cropping, Borderless, and Print Date, that you have changed, to the factory settings.

- 1 Press ▲ or ▼ to choose **Factory Reset**. Press **OK**.
- 2 Press **1** to choose **Yes**.
- 3 Press **Stop/Exit**.

Scan to a memory card or USB Flash memory drive

Auto Crop

You can scan multiple documents placed on the scanner glass. An individual document can be previewed on the LCD before you save it. When you choose **Auto Crop**, the machine will scan each document and create separate files. For example, if you place three documents on the scanner glass, the machine will scan and create three separate files. If you want to create a three page file, choose **PDF** or **TIFF** for **File Type**.

(If you choose **JPEG**, each document is created to three separate files.)

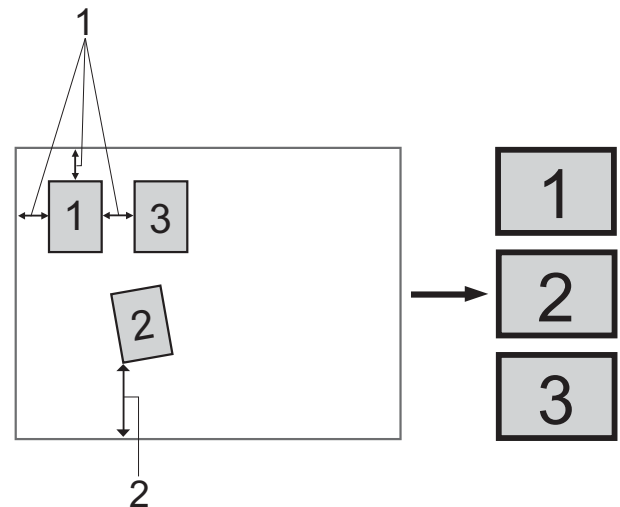

- 1 0.4 in. (10 mm) or greater (top, left, right)
- 2 0.8 in. (20 mm) or greater (bottom)



Note

Auto Crop is supported by technology from Reallusion, Inc. 

- 1 Make sure you have put the memory card or USB Flash memory drive in the proper slot.
- 2 Load your document.

- 3 Press  (**SCAN**).
- 4 Press ▲ or ▼ to choose *Scan to Media*. Press **OK**.
- 5 Press ▲ or ▼ to choose *Auto Crop*.
- 6 Press ◀ or ▶ to choose *On*. Press **OK**.
- 7 If you do not want to change additional settings, press **Black Start** or **Color Start** to start scanning.
- 8 The number of the scanned documents appears on the LCD. Press **OK**.
- 9 Press ◀ or ▶ to preview each document data.
- 10 Press **OK** to save the data.



Note

- *Auto Crop* is available for paper that has all four corners with right angles of 90 degrees. If one of the angles is not square, *Auto Crop* cannot detect the document.
- If your document is too long or wide, this setting does not work properly.
- You must place the documents away from the edges of the scanner glass as shown in the illustration.
- You must place the documents at least 0.4 in. (10 mm) apart from each other.
- *Auto Crop* adjusts the skew of the document on the scanner glass, but if your document is skewed more than 10 degrees, this setting will not work.
- The ADF must be empty to use the *Auto Crop*.
- The *Auto Crop* feature is available for up to a maximum of 16 documents depending on size of your documents.

! IMPORTANT

DO NOT take out the memory card or USB Flash memory drive while **PHOTO CAPTURE** is blinking to avoid damaging the card, USB Flash memory drive or the data stored on them.

How to set a new default

You can save the *Scan to Media* settings (*Quality*, *File Type* and *Auto Crop*) you use most often by setting them as the default settings. These settings will stay until you change them again.

- 1 Press  (**SCAN**).
- 2 Press ▲ or ▼ to choose *Scan to Media*. Press **OK**.
- 3 Press ▲ or ▼ to choose *Set New Default*. Press **OK** and 1 to choose *Yes*.
- 4 Press **Stop/Exit**.

How to reset to the factory settings

You can restore all the *Scan to Media* settings (*Quality*, *File Type* and *Auto Crop*), that you have changed, to the factory settings.

- 1 Press  (**SCAN**).
- 2 Press ▲ or ▼ to choose *Scan to Media*. Press **OK**.
- 3 Press ▲ or ▼ to choose *Factory Reset*. Press **OK** and 1 to choose *Yes*.
- 4 Press **Stop/Exit**.

Printing photos directly from a PictBridge camera



Your Brother machine supports the PictBridge standard, allowing you to connect to and print photos directly from any PictBridge compatible digital camera.

If your camera is using the USB Mass Storage standard, you can also print photos from a digital camera without PictBridge. (See *Printing photos directly from a digital camera (without PictBridge)* on page 57.)

PictBridge requirements

To avoid errors, remember the following points:

- The machine and the digital camera must be connected using a suitable USB cable.
- The image file extension must be .JPG (other image file extensions like .JPEG, .TIF, .GIF and so on will not be recognized).
- PhotoCapture Center® operations are not available when using the PictBridge feature.
- The movie printing function is not available for PictBridge.

Setting your digital camera

Make sure your camera is in PictBridge mode. The following PictBridge settings may be available from the LCD of your PictBridge compatible camera.

Depending on your camera some of these settings may not be available.

Camera Menu Selections	Options
Paper Size	Letter, A4, 4" × 6", Printer Settings (Default setting) ²
Paper Type	Plain Paper, Glossy Paper, Inkjet Paper, Printer Settings (Default setting) ²
Layout	Borderless: On, Borderless: Off, Printer Settings (Default setting) ²
DPOF setting ¹	-
Print Quality	Normal, Fine, Printer Settings (Default setting) ²
Color Enhancement	On, Off, Printer Settings (Default setting) ²
Print Date	On, Off, Printer Settings (Default setting) ²

¹ See *DPOF printing* on page 56 for more details.

² If your camera is set to use the Printer Settings (Default setting), the machine will print your photo using the following settings.

Settings	Options
Paper Size	4" × 6"
Paper Type	Glossy Paper
Layout	Borderless: On
Print Quality	Fine
Color Enhancement	Off
Print Date	Off

- When your camera does not have any menu selections, these settings are also used.
- The names and availability of each setting depends on the specification of your camera.

Please refer to the documentation supplied with your camera for more detailed information on changing PictBridge settings.

Printing Images



Note

Remove any memory cards or USB Flash memory drive from the machine before connecting a digital camera.

- 1 Make sure that your camera is turned off. Connect your camera to the USB direct interface (1) on the machine using the USB cable.

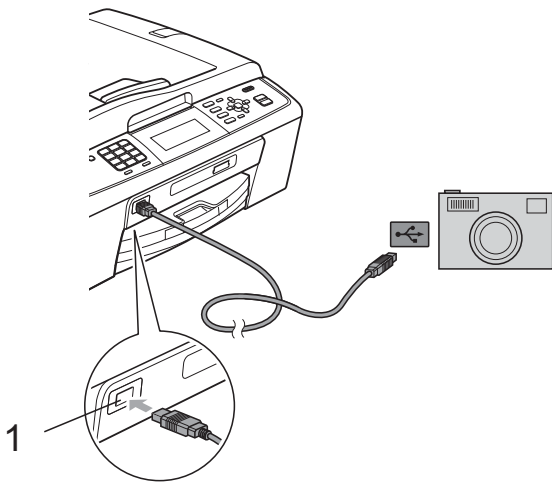

1 USB direct interface

- 2 Turn on the camera. When the machine has recognized the camera, the LCD shows `Camera Connected`.
- 3 Choose the photo you want to print following the instructions from your camera. When the machine starts printing a photo, the LCD will show `Printing`.

! IMPORTANT

To prevent damage to your machine, do not connect any device other than a digital camera or USB Flash memory drive to the USB direct interface.

DPOF printing

DPOF stands for Digital Print Order Format.

Major digital camera manufacturers (Canon Inc., Eastman Kodak Company, FUJIFILM Corporation, Panasonic Corporation and Sony Corporation) created this standard to make it easier to print images from a digital camera.

If your digital camera supports DPOF printing, you will be able to choose on the digital camera display the images and number of copies you want to print.



Note

An Invalid DPOF File error can occur if the print order that was created on the camera has been corrupted. Delete and recreate the print order using your camera to correct this problem. For instructions on how to delete or recreate the print order, refer to your camera manufacturer's support web site or accompanying documentation.

Printing photos directly from a digital camera (without PictBridge)

If your camera is using the USB Mass Storage standard, you can connect your camera in storage mode. This enables you to print photos from your camera.

(If you would like to print photos in PictBridge mode, see *Printing photos directly from a PictBridge camera* on page 55.)



Note

The name, availability and operation differ among digital cameras. Please refer to the documentation supplied with your camera for detailed information, such as how to switch from PictBridge mode to USB mass storage mode.

Printing Images



Note

Remove any memory cards or USB Flash memory drive from the machine before connecting a digital camera.

- 1 Make sure that your camera is turned off. Connect your camera to the USB direct interface (1) on the machine using the USB cable.

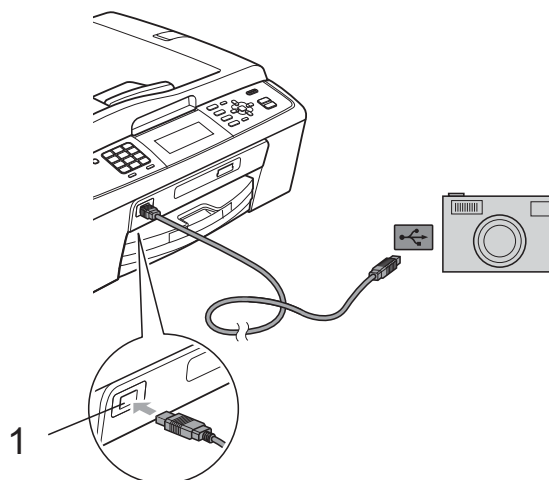

1 USB direct interface

- 2 Turn on the camera.
- 3 Follow the steps in *Print Images* on page 43.

! IMPORTANT

To prevent damage to your machine, do not connect any device other than a digital camera or USB Flash memory drive to the USB direct interface.

A

Routine maintenance

Cleaning and checking the machine

Cleaning the outside of the machine

! IMPORTANT

- Use neutral detergents. Cleaning with volatile liquids such as thinner or benzine will damage the outside surface of the machine.
- DO NOT use cleaning materials that contain ammonia.
- DO NOT use isopropyl alcohol to remove dirt from the control panel. It may crack the panel.

Clean the outside of the machine as follows:

- 1 Pull the paper tray (1) completely out of the machine.

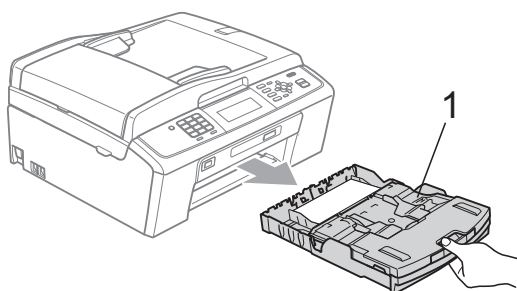

- 2 Wipe the outside of the machine with a *dry*, lint-free soft cloth to remove dust.

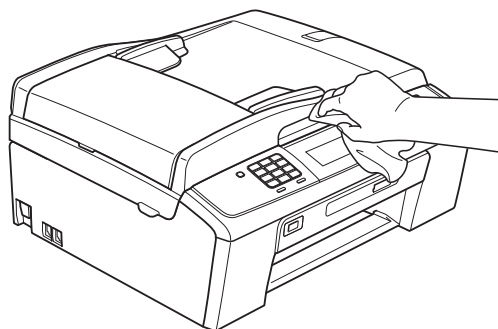

- 3 Lift the output paper tray cover and remove anything that is stuck inside the paper tray.

- 4 Wipe the inside and outside of the paper tray with a *dry*, lint-free soft cloth to remove dust.

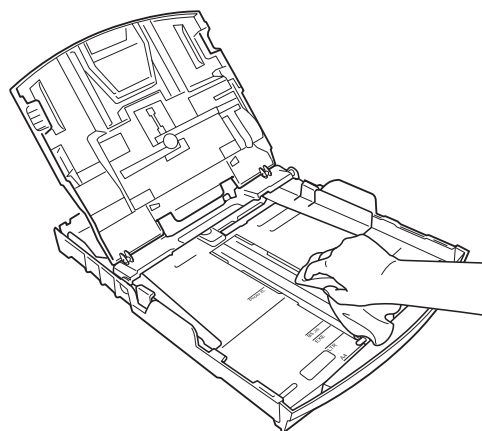

- 5 Close the output paper tray cover and put the output paper tray firmly back in the machine.

Cleaning the scanner

- 1 Lift the document cover (1). Clean the scanner glass (2) and the white plastic (3) with a soft lint-free cloth moistened with a non-flammable glass cleaner.

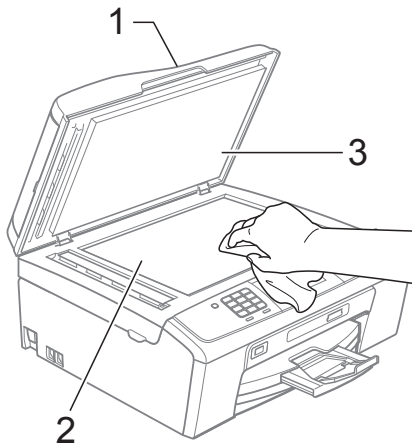

- 2 In the ADF unit, clean the white bar (1) and the glass strip (2) with a lint-free cloth moistened with a non-flammable glass cleaner.

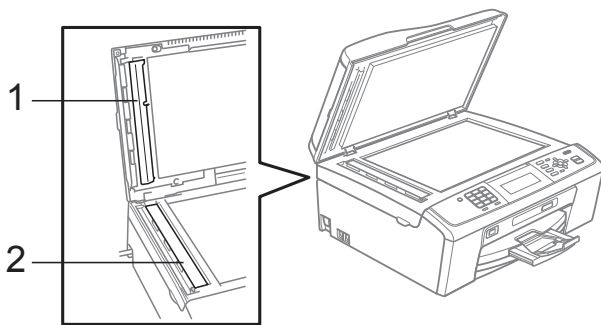

Note

In addition to cleaning the scanner glass and glass strip with a non-flammable glass cleaner, run your finger tip over the glass to see if you can feel anything on it. If you feel dirt or debris, clean the glass again concentrating on that area. You may need to repeat the cleaning process three or four times. To test, make a copy after each cleaning attempt.

Cleaning the machine's printer platen

⚠ CAUTION

Be sure to unplug the machine from the AC power outlet before cleaning the printer platen to avoid electrical shock.

- 1 Lift the scanner cover until it locks securely in the open position.
- 2 Clean the machine's printer platen (1) and the area around it, wiping off any scattered ink with a *dry*, soft lint-free cloth.

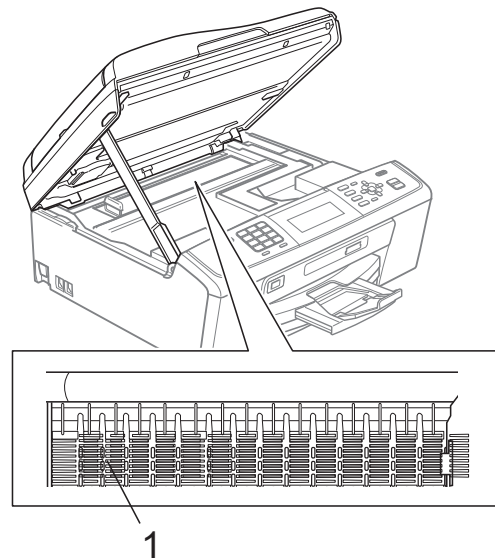

Cleaning the paper pick-up rollers

- 1 Pull the paper tray completely out of the machine.
- 2 Unplug the machine from the AC power outlet and open the Jam Clear Cover (1) at the back of the machine.

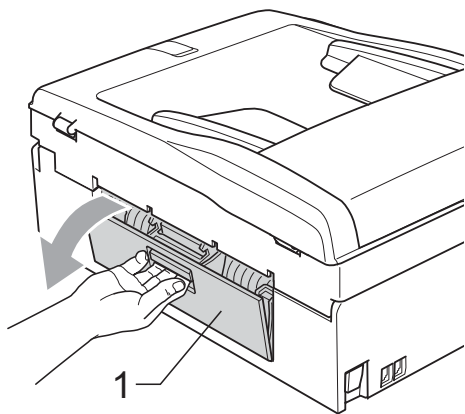

- 3 Clean the Paper Pick-up Rollers (1) with isopropyl alcohol on a cotton swab.

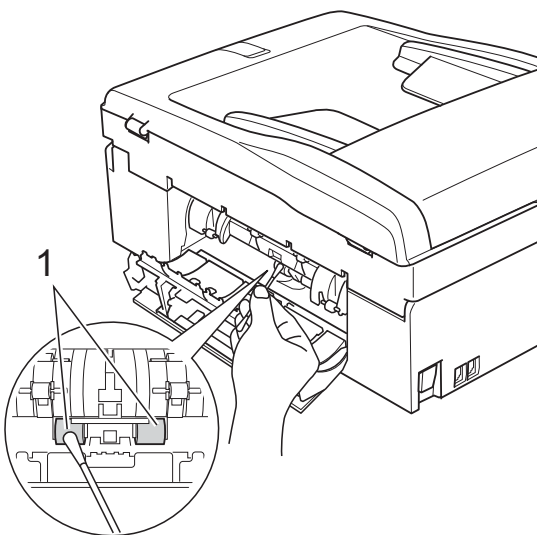

- 4 Close the Jam Clear Cover. Make sure the cover is closed properly.
- 5 Put the paper tray firmly back in the machine.
- 6 Re-connect the power cord.

Cleaning the print head

To maintain good print quality, the machine will automatically clean the print head when needed. You can start the cleaning process manually if there is a print quality problem.

Clean the print head and ink cartridges if you get a horizontal line in the text or graphics or blank text on your printed pages. You can clean Black only, three colors at a time (Cyan/Yellow/Magenta), or all four colors at once.

Cleaning the print head consumes ink. Cleaning too often uses ink unnecessarily.

! IMPORTANT

DO NOT touch the print head. Touching the print head may cause permanent damage and may void the print head's warranty.

- 1 Press **Menu**.
- 2 Press **▲** or **▼** to choose **Ink**. Press **OK**.
- 3 Press **▲** or **▼** to choose **Cleaning**. Press **OK**.
- 4 Press **▲** or **▼** to choose **Black**, **Color** or **All**. Press **OK**.
The machine cleans the print head. When cleaning is finished, the machine will go back to the Ready Screen automatically.



Note

If you clean the print head at least five times and the print has not improved, try installing a new Genuine Brother Brand replacement ink cartridge for each problem color. Try cleaning the print head again up to five more times. If the print has not improved call Brother Customer Service. (See *Brother numbers* on page i in the *Basic User's Guide*.)

Checking the print quality

If faded or streaked colors and text appear on your output, some of the nozzles may be clogged. You can check this by printing the Print Quality Check Sheet and looking at the nozzle check pattern.

- 1 Press **Menu**.
- 2 Press **▲** or **▼** to choose *Ink*. Press **OK**.
- 3 Press **▲** or **▼** to choose *Test Print*. Press **OK**.
- 4 Press **▲** or **▼** to choose *Print Quality*. Press **OK**.
- 5 Press **Color Start**. The machine begins printing the Print Quality Check Sheet.
- 6 Check the quality of the four color blocks on the sheet.
- 7 The LCD asks you if the print quality is OK. Do one of the following:
 - If all lines are clear and visible, press **1 (Yes)** to finish the Print Quality check and go to step 11.
 - If you can see missing short lines as shown below, press **2** to choose *No*.

OK

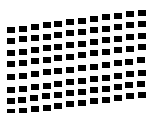

Poor

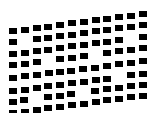

- 8 The LCD asks you if the print quality is OK for black and three colors. Press **1 (Yes)** or **2 (No)**.

- 9 The LCD asks you if you want to start cleaning. Press **1 (Yes)**. The machine starts cleaning the print head.

- 10 After cleaning is finished, press **Color Start**. The machine starts printing the Print Quality Check Sheet again. Return to step 6.

- 11 Press **Stop/Exit**. If you repeat this procedure at least five times and the print quality is still poor, replace the ink cartridge for the clogged color. After replacing the ink cartridge, check the print quality. If the problem still exists, repeat the cleaning and test print procedures at least five times for the new ink cartridge. If ink is still missing, call Brother Customer Service. (See *Brother numbers* on page i in the *Basic User's Guide*.)

! IMPORTANT

DO NOT touch the print head. Touching the print head may cause permanent damage and may void the print head's warranty.



Note



When a print head nozzle is clogged the printed sample looks like this.

After the print head nozzle is cleaned, the horizontal lines are gone.

Checking the print alignment

You may need to adjust the print alignment after transporting the machine if your printed text becomes blurred or images become faded.

- 1 Press **Menu**.
- 2 Press **▲** or **▼** to choose `Ink`. Press **OK**.
- 3 Press **▲** or **▼** to choose `Test Print`. Press **OK**.
- 4 Press **▲** or **▼** to choose `Alignment`. Press **OK**.
- 5 Press **Black Start** or **Color Start**. The machine starts printing the Alignment Check Sheet.
- 6 Check the 600 dpi and 1200 dpi test prints to see if number 5 most closely matches number 0.
- 7 Do one of the following:
 - If the number 5 samples of both the 600 dpi and 1200 dpi test prints are the best matches, press **1** (`Yes`) to finish the Alignment Check and go to step 10.
 - If another test print number is a better match for either 600 dpi or 1200 dpi, press **2** (`No`) to choose it.
- 8 For 600 dpi, press the number of the test print that most closely matches the number 0 sample (1-8).
- 9 For 1200 dpi, press the number of the test print that most closely matches the number 0 sample (1-8).
- 10 Press **Stop/Exit**.

Checking the ink volume

Although an ink volume icon appears on the LCD, you can use the **Menu** key to see a large graph showing the ink that is left in each cartridge.

- 1 Press **Menu**.
- 2 Press **▲** or **▼** to choose `Ink`. Press **OK**.
- 3 Press **▲** or **▼** to choose `Ink Volume`. Press **OK**. The LCD shows the ink volume.
- 4 Press **Stop/Exit**.



Note

You can check the ink volume from your computer. (See *Printing for Windows*[®] or *Printing and Faxing for Macintosh* in the *Software User's Guide*.)

Packing and shipping the machine

When you transport the machine, use the packing materials that came with your machine. If you do not pack the machine properly, any damage that may occur in transit may not be covered by your warranty.

! IMPORTANT

It is important to allow the machine to “park” the print head after a print job. Listen carefully to the machine before unplugging it to make sure that all mechanical noise has stopped. Not allowing the machine to finish this parking process may lead to print problems and possible damage to the print head.

- 1 Open the ink cartridge cover.
- 2 Press the ink release levers to release the ink cartridges and then take out the ink cartridges. (See *Replacing the ink cartridges* in appendix A in the *Basic User's Guide*.)
- 3 Install the green protective part and then close the ink cartridge cover.

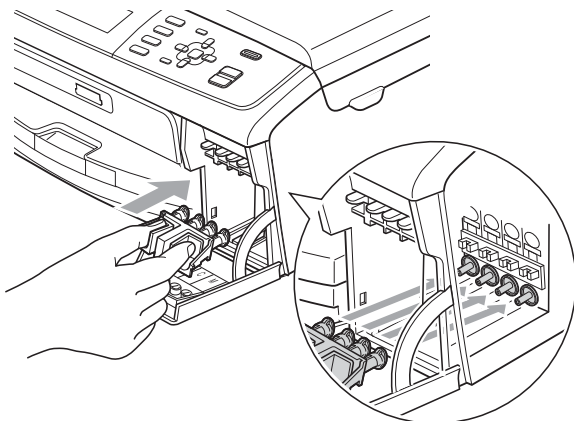

! IMPORTANT

- Make sure that the plastic tabs on both sides of the green protective part (1) have securely clicked into place (2).

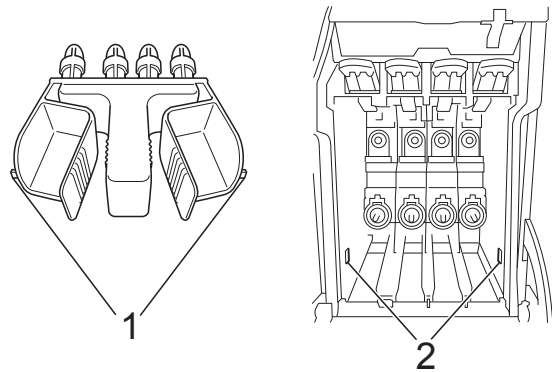

- If you are not able to find the green protective part, DO NOT remove the ink cartridges before shipping. It is essential that the machine be shipped with either the green protective part or the ink cartridges in position. Shipping without them will cause damage to your machine and may void your warranty.

- 4 Lift the machine from the front and hook the tab of the green protective part into the keyed opening (1) on the bottom of the paper tray. Then latch the protective part over the raised portion of the paper tray (2).

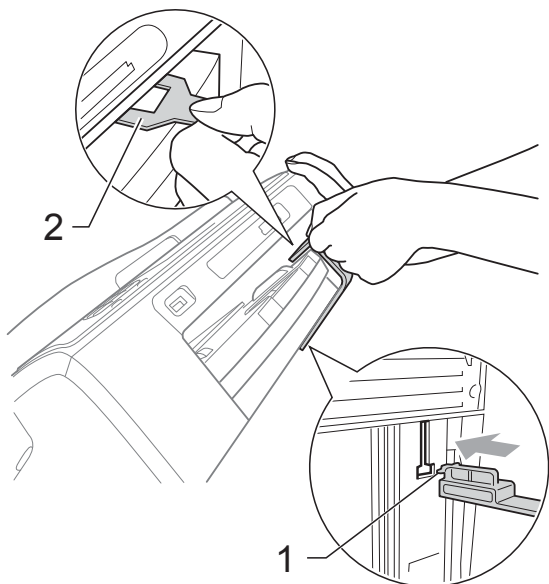

- 5 Unplug the machine from the telephone wall jack and take the telephone line cord out of the machine.

- 6 Unplug the machine from the AC power outlet.

- 7 Using both hands, use the plastic tabs on both sides of the machine to lift the scanner cover until it locks securely into the open position. Then unplug the interface cable from the machine, if it is connected.

- 8 Lift the scanner cover (1) to release the lock. Gently push the scanner cover support down (2) and close the scanner cover (3) using both hands.

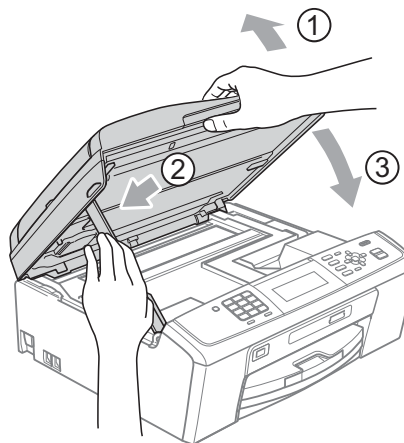

- 9 Wrap the machine in the bag.

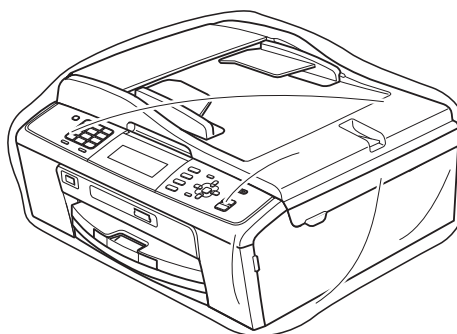
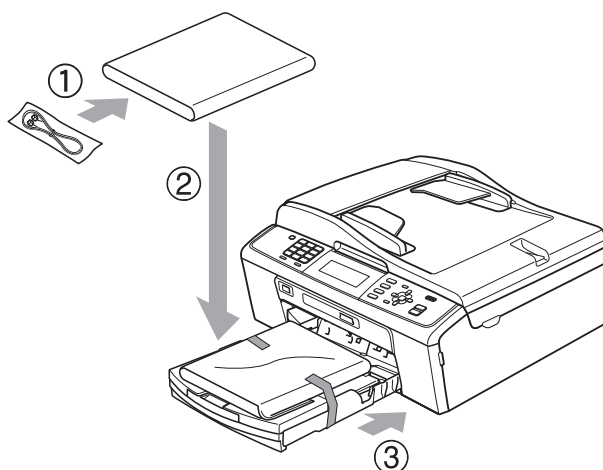

- 10 Pack the machine and the printed materials in the original carton with the original packing material as shown below. Do not pack the used ink cartridges in the carton.

**Note**

If you are returning your machine to Brother as part of the Exchange Service, pack *only* the machine. Keep all separate parts and printed materials to use with your “Exchange” machine.

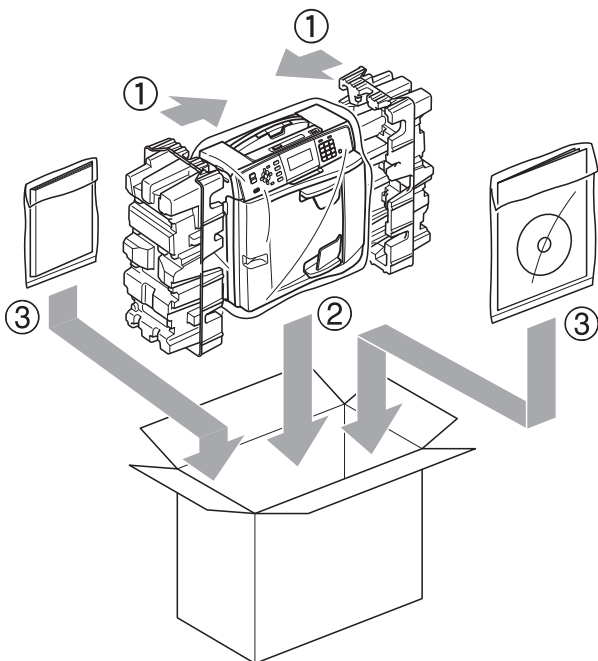

- 11 Close the carton and tape it shut.

B

Glossary

This is a comprehensive list of features and terms that appear in Brother manuals. Availability of these features depends on the model you purchased.

ADF (automatic document feeder)

The document can be placed in the ADF and scanned one page at a time automatically.

Auto Reduction

Reduces the size of incoming faxes.

Automatic Redial

A feature that enables your machine to redial the last fax number after five minutes if the fax did not go through because the line was busy.

Backup Print

Your machine prints a copy of every fax that is received and stored in memory. This is a safety feature so you will not lose messages during a power failure.

Batch Transmission

(Black & white faxes only) As a cost saving feature, all delayed faxes to the same fax number can be sent as one transmission.

Beeper Volume

Volume setting for the beep when you press a key or make an error.

Brightness

Changing the Brightness makes the whole image lighter or darker.

Broadcasting

The ability to send the same fax message to more than one location.

Caller ID

A service purchased from the telephone company that lets you see the number (or name) of the party calling you.

CNG tones

The special tones (beeps) sent by fax machines during automatic transmission to tell the receiving machine that a fax machine is calling.

Coding method

Method of coding the information contained in the document. All fax machines must use a minimum standard of Modified Huffman (MH). Your machine is capable of greater compression methods, Modified Read (MR), Modified Modified Read (MMR) and JPEG, if the receiving machine has the same capability.

Communication error (Comm. Error)

An error during fax sending or receiving, usually caused by line noise or static.

Compatibility group

The ability of one fax unit to communicate with another. Compatibility is assured between ITU-T Groups.

Contrast

Setting to compensate for dark or light documents, by making faxes or copies of dark documents lighter and light documents darker.

Delayed Fax

Sends your fax at a specified time later.

Density

Changing the Density makes the whole image lighter or darker.

Distinctive Ring

A subscriber service purchased from the telephone company that gives you another telephone number on an existing telephone line. The Brother machine uses the new number to simulate a dedicated fax line.

Dual Access

Your machine can scan outgoing faxes or scheduled jobs into memory at the same time it is sending a fax from memory or receiving or printing an incoming fax.

Easy Receive

Enables your machine to respond to CNG tones if you interrupt a fax call by answering it.

ECM (Error Correction Mode)

Detects errors during fax transmission and resends the pages of the fax that had an error.

Extension telephone

A telephone using the same line as your fax but plugged into a separate wall jack.

External telephone

A telephone that is plugged into the EXT.jack of your machine.

F/T Ring Time

The length of time that the Brother machine rings (when the Receive Mode setting is Fax/Tel) to notify you to pick up a voice call that it answered.

Fax Forwarding

Sends a fax received into the memory to another pre-programmed fax number.

Fax Journal

Lists information about the last 200 incoming and outgoing faxes. TX means Transmit. RX means Receive.

Fax Receive Code

Press this code (* 5 1) when you answer a fax call on an extension or external telephone.

Fax Storage

You can store received faxes in memory.

Fax tones

The signals sent by sending and receiving fax machines while communicating information.

Fax/Tel

You can receive faxes and telephone calls. Do not use this mode if you are using a telephone answering device (TAD).

Fine resolution

Resolution is 203 × 196 dpi. It is used for small print and graphs.

Gray Scale

The shades of gray available for copying, scanning and faxing photographs.

Group number

A combination of Speed Dial numbers that are stored in a Speed Dial location for Broadcasting.

Help list

A printout of the complete Menu table that you can use to program your machine when you do not have the Basic User's Guide with you.

Innobella™

Innobella™ is a range of genuine consumables offered by Brother. For best quality results Brother recommends Innobella™ Ink and Paper.

Journal Period

The pre-programmed time period between automatically printed Fax Journal Reports. You can print the Fax Journal on demand without interrupting the cycle.

LCD (Liquid Crystal Display)

The LCD screen on the machine that shows interactive messages during On-Screen Programming and shows the date and time when the machine is idle.

Manual fax

You can lift the handset of the external telephone or you can press **Hook** to hear the receiving fax machine answer before you press **Black Start** or **Color Start** to begin sending.

Memory Receive

Receives faxes into the machine's memory when the machine is out of paper.

Menu mode

Programming mode for changing your machine's settings.

OCR (optical character recognition)

ScanSoft™ PaperPort™ 11SE with OCR or Presto! PageManager software application converts an image of text to text you can edit.

Overseas Mode

Makes temporary changes to the fax tones to accommodate noise and static on overseas telephone lines.

Paging

This feature enables your machine to call your pager when a fax is received into its memory. The machine will also page for voice messages.

Pause

Allows you to place a 3.5 second delay in the dialing sequence while you are dialing using the dial pad or while you are storing Speed Dial numbers. Press

Redial/Pause as many times as needed for longer pauses.

PhotoCapture Center®

Allows you to print digital photos from your digital camera at high resolution for photo quality printing.

Photo resolution (B&W only)

A resolution setting that uses varying shades of gray for the best representation of photographs.

PictBridge

Allows you to print photos directly from your digital camera at high resolution for photo quality printing.

Polling

The process of a fax machine calling another fax machine to retrieve waiting fax messages.

Pulse (Canada only)

A form of rotary dialing on a telephone line.

Quick Dial List

A listing of names and numbers stored in Speed Dial memory, in numerical order.

Real Time Transmission

When memory is full, you can send faxes in real time.

Remaining jobs

You can check which jobs are waiting in memory and cancel jobs individually.

Remote Access Code

Your own four-digit code (---*) that allows you to call and access your machine from a remote location.

Remote Retrieval Access

The ability to access your machine remotely from a touch-tone telephone.

Resolution

The number of vertical and horizontal lines per inch. See: Standard, Fine, Super Fine and Photo.

Ring Delay

The number of rings before the machine answers in *Fax Only* and *Fax/Tel* modes.

Ring Volume

Volume setting for the machine's ring.

Scanning

The process of sending an electronic image of a paper document into your computer.

Scan to Media

You can scan a black & white or color document into a memory card or USB Flash memory drive. Black & white images can be in TIFF or PDF file format and color images can be in PDF or JPEG file format.

Search

An electronic, numerical or alphabetical listing of stored Speed Dial and Group numbers.

Speed Dial

A pre-programmed number for easy dialing. You must press  (**Speed Dial**), the two digit code, and **Black Start** or **Color Start** to start the dialing process.

Standard resolution

203 × 97 dpi. It is used for regular size text and quickest transmission.

Station ID

The stored information that appears on the top of faxed pages. It includes the sender's name and fax number.

Super Fine resolution (B&W)

392 × 203 dpi. Best for very small print and line art.

TAD (telephone answering device)

You can connect an external telephone answering device or answering machine to the EXT. jack of your machine.

**Telephone Answer Code
(For Fax/Tel mode only)**

When the machine answers a voice call, it pseudo/double-rings. You can pick up at an extension telephone by pressing this code (**# 5 1**).

Temporary settings

You can choose certain options for each fax transmission and copy without changing the default settings.

Tone

A form of dialing on the telephone line used for touch-tone telephones.

Transmission

The process of sending faxes over the phone lines from your machine to the receiving fax machine.

Transmission Verification Report

A listing for the last fax sent, that shows its date, time and number.

True2Life®

Adjusts the color in the image for better print quality by improving sharpness, white balance and color density.

User Settings

A printed report that shows the current settings of the machine.

WLAN Report

A printed report that shows the result of the WLAN Connection.

C

Index

A	
<hr/>	
Access codes, storing and dialing	29
Apple Macintosh	
See Software User's Guide.	
B	
<hr/>	
Broadcasting	10
setting up Groups for	31
C	
<hr/>	
Caller ID	25
Caller ID history	28
Caller ID History report	34
Setting up your area code	26
Canceling	
Fax Forwarding	21
jobs awaiting redial	13
Paging	21
Cleaning	
paper pick-up roller	60
print head	60
printer platen	59
scanner	59
Connecting	
two-line external TAD or telephone	27
ControlCenter	
See Software User's Guide.	
Copy	
book	39
density	38
enlarge/reduce	35
ink save mode	38
page layout (N in 1)	37
quality	35
return to factory settings	41
set new default	41
sort (ADF only)	38
using ADF	38
Watermark	40
using a media card	40
using a paper document	41
using a template	40
using a USB Flash memory drive	40
D	
<hr/>	
Dialing	
access codes and credit card	
numbers	29
Caller ID history	28
Groups	10
Outgoing Call	28
Direct printing	
from a non-PictBridge camera	57
from a PictBridge camera	55
Dual Access	10
F	
<hr/>	
Fax codes	
changing	20
Remote Access Code	20
Fax Forwarding	
changing remotely	21, 22
programming a number	15
Fax Storage	16
printing from memory	17
turning off	19
turning on	16
Fax, from PC	
See Software User's Guide.	
Fax, stand-alone	
receiving	
at end of conversation	23
Fax Forwarding	21
into PC	17
into the memory	15
out of paper reception	15
Paging	16
printing from memory	17
reducing to fit on paper	23
retrieving from a remote site	21, 22
sending	8
at end of conversation	10
Broadcasting	10
canceling from memory	13
contrast	8
delayed batch transmission	13
delayed fax	12
from memory (Dual Access)	10
manual	10

overseas	12
Real Time Transmission	12
Resolution	9
return to factory setting	9
set new default	9

G

Groups for Broadcasting	31
-------------------------------	----

I

Ink cartridges	
checking ink volume	62

J

Jacks	
Convert to RJ11 jack triplex adapter	26
EXT	
TAD	27

L

LCD (Liquid Crystal Display)	
Brightness	4
Dim Timer	4
Help List	34

M

Macintosh	
See Software User's Guide.	
Manual	
transmission	10
Memory Storage	1
Mode, entering	
Timer	5
Movie printing	43

N

Network	
Printing	
See Network User's Guide.	
Scanning	
See Software User's Guide.	

O

Out of Area (Caller ID)	25
-------------------------------	----

P

Packing and shipping the machine	63
Paging	16
PaperPort™ 11SE with OCR	
See Software User's Guide. See also Help in the PaperPort™ 11SE application.	
PhotoCapture Center®	
DPOF printing	49
from PC	
See Software User's Guide.	
Photo Effects	
Auto Correct	45
Enhance Scenery	46
Enhance Skin-Tone	46
Monochrome	47
Remove Red-Eye	46
Sepia	47
Print settings	
Borderless	52
Brightness	51
Contrast	51
Cropping	52
Paper type & size	50
Print Date	52
Quality	50
Return to factory setting	53
Set new default	52
Printing	
all photos	45
index	43
photos	44
Scan to Media	
auto crop	53
memory card	53
USB Flash memory	53
Search by Date	48
Slide-Show	48
Trimming	49
PictBridge	
DPOF Printing	56
Power failure	1
Presto! PageManager	
See Software User's Guide. See also Help in the Presto! PageManager application.	

Print	
checking alignment	62
checking quality	61
fax from memory	17
report	34
Printing	
See Software User's Guide.	

Q

Quick Dial	
Access codes and credit card numbers	29
Broadcasting	10
using Groups	10
Group dial	
changing	32
setting up Groups for Broadcasting ...	31
Speed Dial	
setting up from Caller ID history	30
setting up from outgoing calls	30

R

Reducing	
copies	35
incoming faxes	23
Remote Retrieval	20
access code	20
commands	21
getting your faxes	22
Remote Setup	
See Software User's Guide.	
Reports	33
Caller ID History Report	34
Fax Journal	34
Journal Period	33
Help List	34
how to print	34
Network Configuration	34
Quick Dial List	34
Transmission Verification	33, 34
User Settings	34
WLAN Report	34
Resolution	
setting for next fax	9

S

Scanning	
See Software User's Guide.	
Shipping the machine	63
Sleep Mode	3
Speed Dial	
storing	30

T

TAD (telephone answering device),	
external	27
with two-line jack	27
Telephone line	
roll over lines	26
two-line telephone system	26
Troubleshooting	
checking ink volume	62
Two-line telephone system	26
TX Lock	
turning on/off	7

V

Volume, setting	
beeper	2
ring	1
speaker	2

W

Windows®	
See Software User's Guide.	
Wireless Network	
See Quick Setup Guide and Network User's Guide.	

Brother International Corporation
100 Somerset Corporate Boulevard
P.O. Box 6911
Bridgewater, NJ 08807-0911 USA

Brother International Corporation (Canada) Ltd.
1 rue Hôtel de Ville,
Dollard-des-Ormeaux, QC, Canada H9B 3H6

brother®

Visit us on the World Wide Web
<http://www.brother.com>

These machines are made for use in the USA and Canada only. We cannot recommend using them overseas because it may violate the Telecommunications Regulations of that country and the power requirements of your multi-function center may not be compatible with the power available in foreign countries. **Using USA or Canada models overseas is at your own risk and may void your warranty.**