

i n v e n t

hp color LaserJet  
2500 series

use



# HP Color LaserJet 2500 series printer

**User guide** 

---

## Copyright and License

©Copyright Hewlett-Packard Company 2003

All Rights Reserved. Except as allowed by copyright laws or herein, reproduction, adaptation, or translation without prior written permission is prohibited.

A user of the Hewlett-Packard printer associated with this user guide is granted a license to: a) print hard copies of this user guide for PERSONAL, INTERNAL or COMPANY use subject to the restriction not to sell, re-sell or otherwise distribute the hard copies; and b) place an electronic copy of this user guide on a network server, provided access to the electronic copy is limited to PERSONAL, INTERNAL users of the Hewlett-Packard printer associated with this user guide.

The information contained in this document is subject to change without notice.

Part number C9706-90960  
Edition 1, 1/2003

## Trademark Credits

Adobe Photoshop® is a trademark of Adobe Systems Incorporated.

CorelDRAW™ is a trademark of Corel.

ENERGY STAR® and the Energy Star logo are U.S. registered marks of the United States Environmental Protection Agency.

Microsoft®, Windows®, MS-DOS®, and Windows NT® are U.S. registered trademarks of Microsoft Corporation.

Netscape™ and Netscape Navigator™ are U.S. trademarks of Netscape Communications Corporation.

TrueType™ is a U.S. trademark of Apple Computer, Inc.

UNIX® is a registered trademark of The Open Group.

# HP Customer Care

## Telephone support

HP provides free telephone support during the warranty period. When you call, you will be connected to a responsive team waiting to help you. For the telephone number for your country/region, see the flyer that shipped in the box with the product. Before calling HP, have the following information ready: product name and serial number, date of purchase, and description of the problem.

You can also find support on the Internet at <http://www.hp.com>. In the **Select your country or region** field in the top, right corner, select your country/region and click . Click the **Support** block.

## Online and other support

<b>Online Services:</b> for 24-hour access to information using a modem or Internet connection	<i>World Wide Web URL:</i> Updated HP printer software, product and support information, and printer drivers in several languages can be obtained from: <a href="http://www.hp.com/go/clj2500">http://www.hp.com/go/clj2500</a> . (Site is in English.)  <i>Printer drivers:</i> Visit <a href="http://www.hp.com">http://www.hp.com</a> . In the <b>Select your country or region</b> field in the top, right corner, select your country/region and click  . Click the <b>Drivers</b> block, and then enter <b>color laserjet 2500</b> as the product name. The Web page for the drivers might be in English, but you can download the drivers themselves in several languages.
<b>Software utilities, drivers, and electronic information</b>	<i>Visit:</i> <a href="http://www.hp.com/go/support/clj2500">http://www.hp.com/go/support/clj2500</a> . (Site is in English.)  <i>Call:</i> See the flyer that shipped in the box with the product.
<b>HP direct ordering for accessories or supplies</b>	<i>Visit:</i> <a href="http://www.hp.com/go/ljsupplies">http://www.hp.com/go/ljsupplies</a>  <i>Call:</i> 1-800-538-8787 (U.S.) or 1-800-387-3154 (Canada).
<b>HP Support Assistant CD</b>	This support tool offers a comprehensive online information system designed to provide technical and product information on HP products. To subscribe to this quarterly service in the U.S. or Canada, call 1-800-457-1762. In Hong Kong SAR, Indonesia, Malaysia, or Singapore, call Mentor Media at (65) 740-4477.
<b>HP Service Information</b>	To locate HP-Authorized Dealers, call 1-800-243-9816 (U.S.) or 1-800-387-3867 (Canada).  For service for your product, call the customer support number for your country/region. See the flyer that shipped in the box with the printer.
<b>HP Service Agreements</b>	<i>Call:</i> 1-800-835-4747 (U.S.) or 1-800-268-1221 (Canada). <i>Extended Service:</i> 1-800-446-0522



# Contents

HP Customer Care .....	3
------------------------	---

## 1 Printer basics

Introduction .....	9
Printer configurations .....	10
Printer features .....	11
Printer parts .....	13
Interface ports .....	14
Control panel features .....	15
Software and supported operating systems .....	17
Software for Windows .....	18
Software for network installations only .....	19
Software for Macintosh .....	20
Software tips .....	21
Uninstalling the printing software .....	22
Uninstalling software for Windows .....	22
Uninstalling software for Macintosh .....	23
Accessories and ordering information .....	24

## 2 Printing tasks

Introduction .....	27
Choosing paper and other print media .....	28
Supported print media for tray 1 .....	29
Supported print media for optional tray 2 .....	29
Supported print media for optional tray 3 .....	30
Purchasing paper and other print media .....	30
Loading trays .....	31
Loading tray 1 .....	31
Loading optional tray 2 .....	32
Loading optional tray 3 .....	33
Printing a job .....	34
Gaining access to printer driver settings .....	37
Features in the printer driver .....	38
Choosing an output location .....	42
Printing on special print media .....	43
Printing on envelopes .....	43
Printing on labels .....	44
Printing on grayscale transparencies .....	45
Printing on custom-sized print media or cardstock .....	46
Printing on letterhead or preprinted forms .....	47
Printing on both sides (duplexing manually) .....	48
Canceling a print job .....	49
Using color .....	50
HP ImageREt 2400 .....	50
HP ColorSmart .....	51
Managing color options .....	51
Matching colors .....	53
Printing in four-colors (CMYK) .....	53

### 3 Managing the printer

Introduction .....	55
Special pages .....	56
HP Color LaserJet 2500 Toolbox .....	58
Using the embedded Web server .....	60
Using Printer Status and Alerts .....	63

### 4 Problem solving and maintenance

Introduction .....	65
Clearing jams .....	66
Resolving control panel messages .....	71
Supplies Status lights .....	72
Printer Status lights .....	75
Secondary light patterns for Printer Status lights .....	77
Solving print-quality problems .....	80
Solving issues with all printed documents .....	81
Solving issues with color documents .....	87
Resolving problems that generated messages .....	89
Resolving problems that did not generate messages .....	90
Solving general printing problems .....	92
Solving PostScript (PS) errors .....	96
Solving common Macintosh problems .....	97
Cleaning the printer .....	99
Calibrating the printer .....	100
Managing supplies .....	101
Supplies life .....	101
Checking and ordering supplies .....	101
Storing supplies .....	102
Replacing and recycling supplies .....	102
HP policy on non-HP supplies .....	103
HP fraud hotline .....	103

### Appendix A Service and support

Introduction .....	105
Hewlett-Packard limited warranty statement .....	106
Limited warranty for the print cartridges and imaging drum .....	107
Availability of support and service .....	108
HP maintenance agreements .....	108
On-site service agreements .....	108
HP Express Exchange (U.S. and Canada only) .....	109
Repacking the printer .....	110

### Appendix B Specifications and regulatory information

Introduction .....	113
Printer specifications .....	114
Environmental Product Stewardship program .....	116
Protecting the environment .....	116
Material safety data sheet .....	118
FCC regulations .....	119
Regulatory statements .....	120
Declaration of Conformity .....	120
Laser safety statement .....	121
Canadian DOC statement .....	121
VCCI statement (Japan) .....	121
Korean EMI statement .....	121
Finnish laser statement .....	122



## Appendix C Print media specifications

Introduction . . . . .	123
General guidelines . . . . .	124
Tray specifications . . . . .	125
Paper and print media . . . . .	127
Envelopes . . . . .	130
Labels . . . . .	132
Grayscale transparencies . . . . .	132

## Appendix D Working with memory and print server cards

Introduction . . . . .	133
Printer memory . . . . .	134
Installing memory and font DIMMs . . . . .	135
Checking DIMM installation. . . . .	137
Enabling memory . . . . .	138
Enabling the language font DIMM. . . . .	138
Installing an HP Jetdirect print server card . . . . .	139

## Index



# 1

# Printer basics

## Introduction

This section provides information about the following topics:

- “Printer configurations” on page 10
- “Printer features” on page 11
- “Printer parts” on page 13
- “Software and supported operating systems” on page 17
- “Software for Windows” on page 18
- “Software for Macintosh” on page 20
- “Software tips” on page 21
- “Uninstalling the printing software” on page 22
- “Accessories and ordering information” on page 24

## Printer configurations

Thank you for purchasing the HP Color LaserJet 2500 series printer. This printer is available in the configurations described below.



### HP Color LaserJet 2500L

The HP Color LaserJet 2500L printer is a four-color laser printer that prints at 16 pages per minute (ppm) in black and white, and 4 ppm in color.

- **Trays.** The printer comes with a multipurpose tray (tray 1) that holds up to 125 sheets of various print media or 10 envelopes. Compatible with and optional 250-sheet tray (tray 2) for standard sizes and optional 500-sheet tray (tray 3) for A4 and letter sizes. (Optional tray 2 must be installed in order to install optional tray 3.)
- **Connectivity.** The printer provides parallel and universal serial bus (USB) ports for connectivity. (You cannot connect both at the same time.) The printer also contains an enhanced input/output (EIO) slot for installing an optional HP Jetdirect print server card.
- **Memory.** The printer contains three dual inline memory module (DIMM) slots. The standard 64-megabyte (MB) random access memory (RAM) DIMM resides in one of the slots. You can expand the printer memory to a total of 256 MB using 32-, 64-, or 128-MB RAM DIMMs. You can also install a language font DIMM in one of the DIMM slots.



### HP Color LaserJet 2500

The HP Color LaserJet 2500 printer comes with the features that the 2500L model provides as well as tray 2. This model is compatible with optional tray 3.

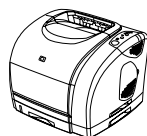

### HP Color LaserJet 2500n

The HP Color LaserJet 2500n printer comes with the features that the 2500 model provides as well as an HP Jetdirect print server card for connecting to a 10/100 Base-T network. This model is compatible with optional tray 3.

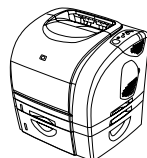

### HP Color LaserJet 2500tn

The HP Color LaserJet 2500tn printer comes with the features that the 2500n model provides as well as tray 3.

# Printer features

---

Color printing	<ul style="list-style-type: none"><li>● Capable of laser printing in full color using the four process colors: cyan, magenta, yellow, and black.</li></ul>
Fast print speed	<ul style="list-style-type: none"><li>● Prints A4/letter-size paper at 16 ppm for black or 4 ppm for color.</li></ul>
Excellent print quality	<ul style="list-style-type: none"><li>● True 600 by 600 dots per inch (dpi) text and graphics.</li><li>● ImageREt 2400 provides 2400 dpi color laser-class quality through a multilevel printing process.</li><li>● Adjustable settings to optimize print quality.</li><li>● The HP UltraPrecise print cartridge has a finer toner formulation that provides sharper text and graphics.</li></ul>
Ease of use	<ul style="list-style-type: none"><li>● Few supplies to order. Supplies are easy to install.</li><li>● Convenient access to printer information and settings using software tools (HP Color LaserJet 2500 Toolbox, embedded Web server, Printer Status and Alerts).</li></ul>
Expandability	<ul style="list-style-type: none"><li>● Optional tray 2. Included with the 2500, 2500n, and 2500tn models; compatible with the 2500L model. This 250-sheet tray for standard sizes reduces the frequency with which you have to add paper to the printer. Only one 250-sheet tray can be installed on the printer.</li><li>● Tray 3. Included with the 2500tn model; compatible with the 2500L, 2500, and 2500n models. This 500-sheet tray for letter and A4 sizes reduces how often you have to add paper to the printer. Only one 500-sheet tray can be installed on the printer. Optional tray 2 must be installed to install an optional tray 3.</li><li>● Optional HP Jetdirect print server card for connecting to a network. Included with the 2500n and 2500tn models; compatible with the 2500L and 2500 models.</li><li>● Two DIMM slots for adding memory and fonts.</li></ul>
Flexible paper handling	<ul style="list-style-type: none"><li>● Adjustable tray 1 (multipurpose tray) for letterhead, envelopes, labels, grayscale transparencies, custom-sized media, postcards, and heavy paper.</li><li>● Optional tray 2 (250-sheet tray) for standard-size paper.</li><li>● Optional tray 3 (500-sheet tray) for letter- and A4-size paper. (Optional tray 2 must be installed in order to install optional tray 3.)</li><li>● One 125-sheet output bin and one output door. Select the top output bin (face down) for most jobs, including grayscale transparencies. Use the rear output door (face up) for jobs on heavy paper, light paper, or special print media.</li><li>● Straight-through paper path capability from tray 1 to the rear output door.</li><li>● Manual duplexing. See <a href="#">“Printing on both sides (duplexing manually)” on page 48</a>.</li></ul>
Printer control language (PCL) printer language and fonts	<ul style="list-style-type: none"><li>● Fast printing performance, built-in Intellifont and TrueType™ scaling technologies, built-in HP-GL/2 vector graphics, and advanced imaging capabilities are benefits of the PCL 6 printer language. PCL 6 also includes 45 scalable TrueType fonts and one bitmapped Line Printer Font. PCL 6 printer language also included.</li></ul>
PostScript (PS) 3 emulation language and fonts	<ul style="list-style-type: none"><li>● PS 3 emulation with 35 built-in PS language fonts included.</li></ul>
Automatic language switching	<ul style="list-style-type: none"><li>● The printer automatically determines and switches to the appropriate printer language (such as PS 3 emulation) for the print job.</li></ul>
Interface connections	<ul style="list-style-type: none"><li>● Bidirectional ECP type-B parallel port (IEEE-1284 compliant).</li><li>● USB port. A parallel cable and a USB cable cannot be connected at the same time. If they are, USB disables itself.</li><li>● EIO slot in the 2500L and 2500 models. The 2500n and 2500tn models include the optional HP Jetdirect print server card.</li></ul>

---

---

## Networking

- The 2500L and 2500 models provide an EIO slot for an optional HP Jetdirect print server card for fast and easy connectivity. (The 2500n and 2500tn models include the HP Jetdirect print server card.)
- All common network protocols such as Ethernet, Token Ring, and LocalTalk are available using HP Jetdirect print server cards.
- Wireless networking (802.11b) is available with the HP Jetdirect print server card (model J6058A).

---

## Enhanced memory and memory expansion

- The printer comes with 64 MB of memory and can be expanded to 256 MB with the DIMM slots. Most documents can be printed using the standard amount of printer memory through the aid of Memory Enhancement technology (MEt). MEt automatically compresses data, virtually doubling the printer memory and allowing more complex printing with available memory.

---

## Energy savings

- The printer automatically conserves electricity by substantially reducing power consumption when not printing.
- As an ENERGY STAR® partner, Hewlett-Packard Company has determined that this product meets ENERGY STAR guidelines for energy efficiency. ENERGY STAR® is a U.S. registered service mark of the United States Environmental Protection Agency.

---

## Economical printing

- N-up printing and two-sided printing using manual duplexing saves paper. See [“Printing multiple pages on one sheet of paper \(N-up printing\)” on page 40](#) and [“Printing on both sides \(duplexing manually\)” on page 48](#).

---

## Print cartridges

- Supplies Status page with print cartridge and imaging drum gauges to display life remaining. For HP supplies only.
  - No-shake cartridge design.
  - Authentication for HP print cartridges.
  - Enabled supplies ordering capability.
-

# Printer parts

Before using the printer, familiarize yourself with the parts of the printer.

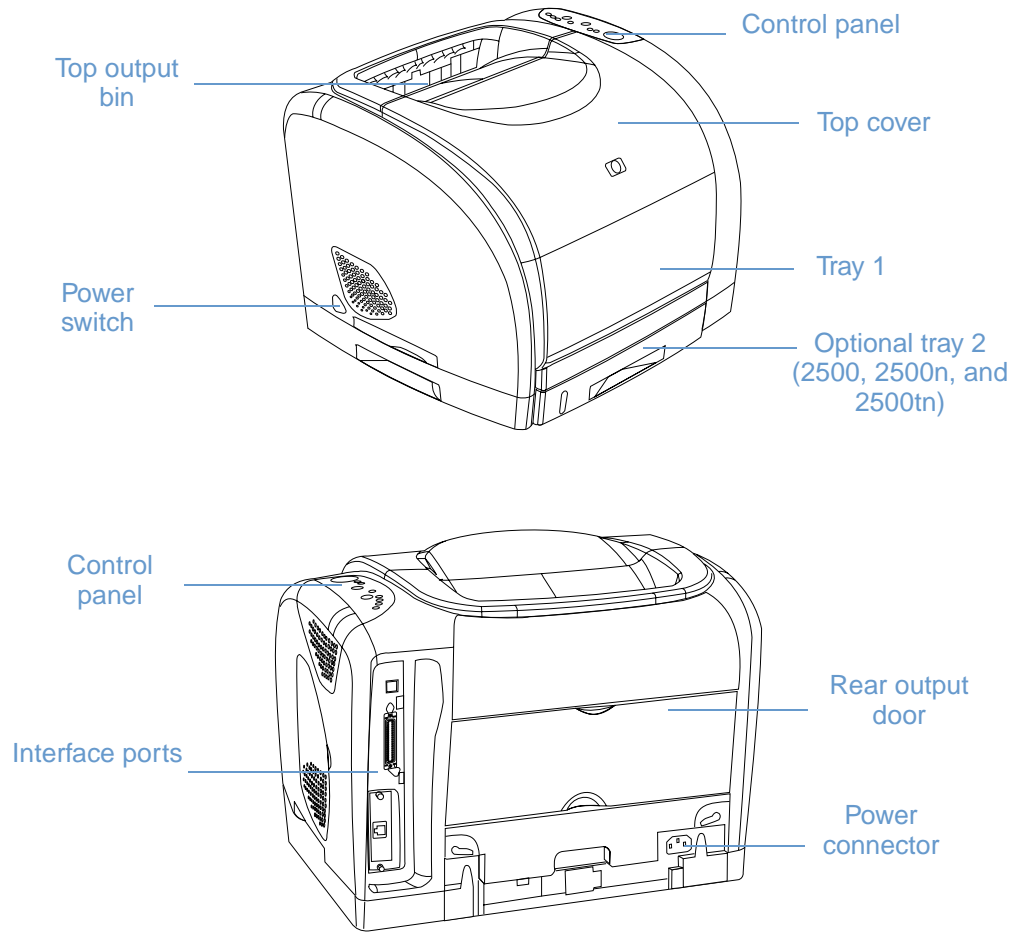

## Interface ports

All 2500 series printers have two interface ports: an IEEE-1284B parallel port and a USB port. The 2500L and 2500 models also contain an EIO slot for installing an optional HP Jetdirect print server card. To order, see [“Accessories and ordering information” on page 24](#), or contact your local HP dealer.

The 2500n and 2500tn models include an HP JetDirect print server card (J6057A) that contains a 10/100 Base-T (RJ-45) port.

---

### Note

You cannot connect the printer to one computer using the parallel cable and to another computer using the USB cable. If you connect both types of cables, the USB disables itself. However, you can connect one of the cables while the printer is connected to the network using an installed HP Jetdirect print server card.

---

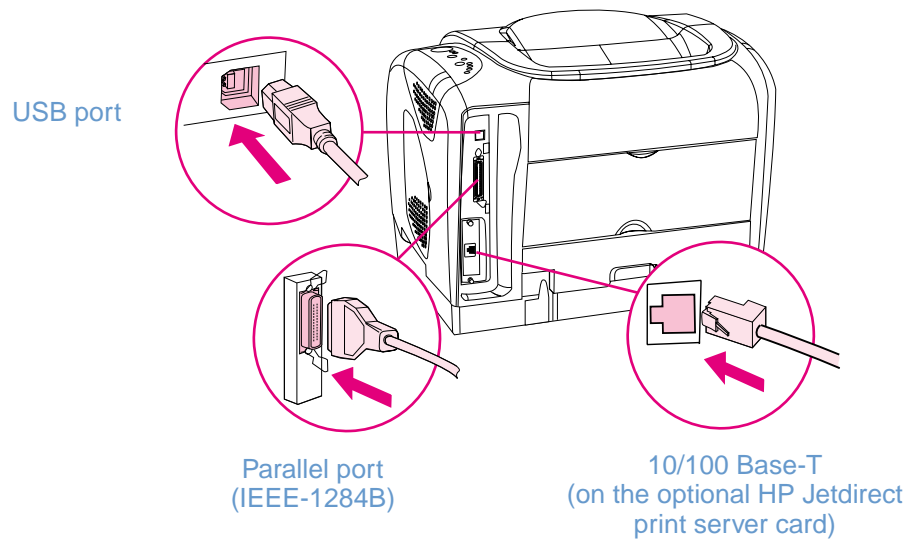

Because an HP Jetdirect print server card is not included with all models, it will be referred to as the optional HP Jetdirect print server card in this documentation.



## Control panel features

The printer contains the following lights and buttons on its control panel:

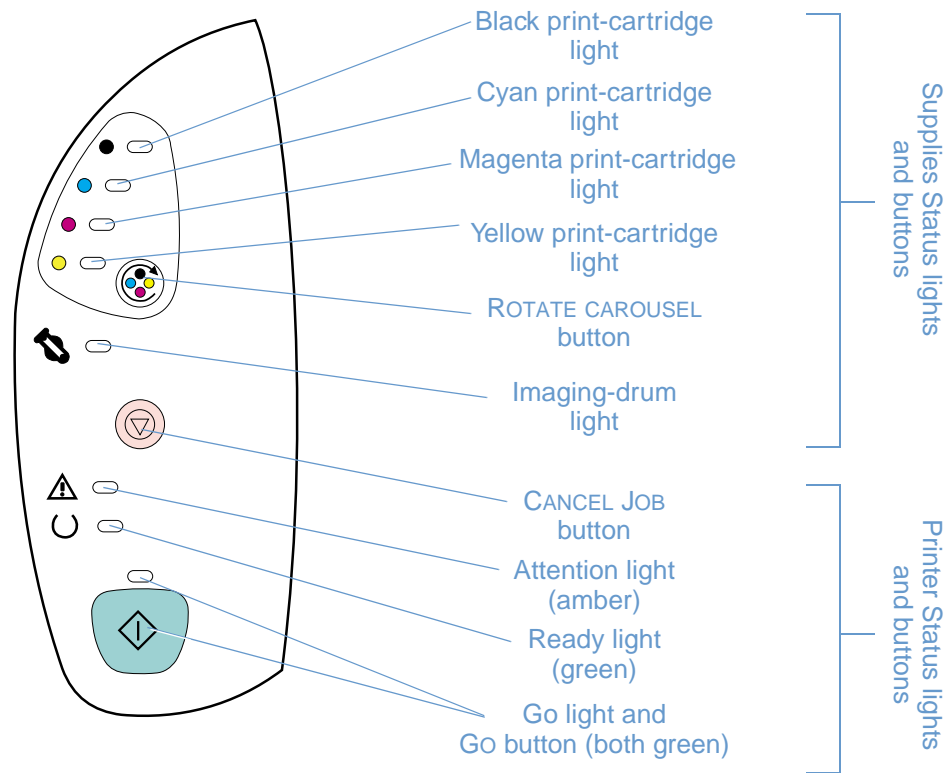

The lights and buttons are arranged into two main groups: Supplies Status (top) and Printer Status (bottom). To interpret and troubleshoot control panel light messages, see [“Resolving control panel messages” on page 71](#).

### Understanding Supplies Status

The printer contains five lights and one button to indicate and control the status of the print cartridges and imaging drum. To interpret and troubleshoot control panel light messages, see [“Resolving control panel messages” on page 71](#).

#### Black, Cyan, Magenta, and Yellow Supplies Status lights

These lights indicate when a print cartridge is low (light is on), empty or missing (light blinks), or the first time you install a non-HP print cartridge (light blinks and Attention light is on). These lights will not indicate low or empty status for non-HP print cartridges.

#### Rotate Carousel button

When the top cover is closed, pressing  (ROTATE CAROUSEL) rotates the print-cartridge carousel to bring the next print cartridge into the top position. The light for the print cartridge that is approaching the top position blinks quickly two or three times.





#### Imaging drum light

This light indicates when the imaging drum is low (light is on) empty or missing (light blinks), or the first time you install a non-HP imaging drum (light blinks and Attention light is on). This light will not indicate low or empty status for non-HP imaging drums.

## Understanding Printer Status

The printer has two buttons and three lights to indicate and control the printer status. To interpret and troubleshoot control panel light messages, see [“Resolving control panel messages” on page 71](#).

### Cancel Job button

- When the Ready light is blinking, pressing  (CANCEL JOB) cancels the current job.
- When the printer is not experiencing an error, pressing  (GO) and  (CANCEL JOB) simultaneously prints a Configuration page and a Supplies Status page. (If an HP Jetdirect print server card is installed, an HP Jetdirect page also prints.)
- When a Supplies Status light is blinking and the Attention light is on (indicating a non-HP supply has been installed), pressing  (CANCEL JOB) allows you to continue printing.

---

### CAUTION

You will not receive any indication when a non-HP supply is empty. If you continue printing after the supply is empty, damage to the printer can occur. See [“Hewlett-Packard limited warranty statement” on page 106](#).

### Attention light







Generally, the Attention light blinks when the printer is out of paper, when a jam has occurred, or when other problems that need attention occur.

The Attention light is on in conjunction and one of the Supplies Status lights is blinking the first time a non-HP supply is installed.

### Ready light

The Ready light is on when the printer is ready to print (experiencing no errors that prevent printing) and blinks when it is receiving data to be printed.

### Go light and Go button

- When the Go light is on and the Attention light is blinking, pressing  (GO) continues the print job after you load paper for a manual feed or clears some errors.
- When the Go light is blinking, the top cover has been opened and then closed or you have pressed  (ROTATE CAROUSEL). Pressing  (GO) returns the printer to the Ready state. If you do not press  (GO), the printer returns to the Ready state on its own after approximately eight seconds.
- When the Go light is off, pressing  (GO) prints a Demo page. Pressing  (GO) and  (CANCEL JOB) simultaneously prints a Configuration page and a Supplies Status page. (If an HP Jetdirect print server card is installed, an HP Jetdirect page also prints.)

## Software and supported operating systems

For easy printer setup and access to the full range of printer features, HP strongly recommends that you install the software provided. Not all software is available in all languages. See the getting started guide for installation instructions, and see the Readme for the latest software information.

The most recent drivers, additional drivers, and other software are available from the Internet and other sources. If you do not have access to the Internet, see [“HP Customer Care” on page 3](#).

The printer comes with software for the following operating systems:

- Microsoft® Windows® 95 (printer driver only), Windows 98, Windows NT® 4.0, Windows 2000, Windows Millennium Edition (Me), and Windows XP
- Macintosh System 8.6 and later

The table lists the software that is available for your operating system.

	Windows 95	Windows 98, Me	Windows NT 4.0, 2000, XP*	Macintosh	UNIX®, Linux	OS/2
Windows Installer		✓	✓			
PCL 6 printer driver	✓	✓	✓			
PCL 5c printer driver	✓	✓	✓			
PS 3 emulation printer driver	✓	✓	✓			
HP Web Jetadmin software			✓*			
Printer Status and Alerts software		✓	✓			
HP Color LaserJet 2500 Toolbox		✓	✓			
Embedded Web server		✓	✓	✓**	✓**	✓**
Macintosh Installer				✓		
Macintosh PostScript printer description (PPD) and printer dialog extensions (PDE)				✓		
IBM drivers						✓***
Model scripts					✓****	

\* XP refers to 32-bit. The 64-bit XP only receives the Unidriver.

\*\* Available only in a network installation.

\*\*\* Available on the HP website.

\*\*\*\* Available on the HP website. Not specific to this printer.

## Software for Windows

When you install the software for Windows, you can directly connect the printer to a computer using a USB or parallel cable or you can connect the printer to the network using an optional HP Jetdirect print server card. Different software is available depending on the type of installation you chose. See the getting started guide for installation instructions, and see the Readme for latest software information.

The following software is available to all users of the printer, whether you connected the printer directly to a computer using a parallel cable or USB cable, or whether you connected the printer to the network using an HP Jetdirect print server card.

### Printer drivers

A printer driver is a software component that provides access to printer features and provides the means for the computer to communicate with the printer. Choose a printer driver based on the way you use the printer. For help using your printer driver, see [“Gaining access to printer driver settings” on page 37](#).

- Use the PCL 6 printer driver to take full advantage of the printer features. Unless complete backward compatibility with previous PCL drivers or older printers is necessary, the PCL 6 driver is recommended.
- Use the PCL 5c printer driver if you need print results to look consistent with those from older HP LaserJet printers. Certain features are not available in this printer driver. (Do not use the PCL 5c driver for this printer with older printers.)
- Use the PS printer driver for compatibility with PS needs. Certain printer features are not available in this printer driver.

The printer automatically switches between PS 3 emulation and PCL printer languages depending on the driver you have selected.

### Using Help

The printer driver has **Help** dialog boxes that can be activated from the **Help** button in the printer driver, the **F1** key on the computer keyboard, or the question mark symbol (?) in the upper-right corner of the printer driver. These **Help** dialog boxes give detailed information about the specific printer driver. Help for the printer driver is separate from the Help for your program.

### HP Color LaserJet 2500 Toolbox

HP Color LaserJet 2500 Toolbox is only supported for Windows 98 and later. You must have performed a complete software installation in order to use the HP Color LaserJet 2500 Toolbox.

The HP Color LaserJet 2500 Toolbox provides links to printer status information and help information, such as this user guide; and tools for diagnosing and solving problems. You can also view explanations and animations of light messages on the control panel. The HP Color LaserJet 2500 Toolbox also provides printer status and settings information from the embedded Web server. See [“Managing the printer” on page 55](#) for more information.

## Embedded Web server

When the printer is directly connected to a computer, the embedded Web server is supported for Windows 98 and later. When the printer is connected to the network, the embedded Web server is supported for Windows 95 and later, Mac OS 8.6 and later, UNIX, Linux, and OS/2.

With the embedded Web server, you can gain access to the printer settings and information by typing an IP address in a Web browser (such as Netscape Navigator™ or Microsoft Internet Explorer) on any computer. You can use the embedded Web server to configure the printer and view status information, as well as view a textual message regarding what a Status light message on the printer means. See “[Managing the printer](#)” on page 55 for more information.

## Printer Status and Alerts

Printer Status and Alerts software provides optional printer and job status alerts. These alerts include notification of jams, of print cartridges being low, or of jobs failing to print because a print cartridge is empty. You can also view device-status information that is stored in the embedded Web server. See “[Managing the printer](#)” on page 55 for more information.

## Software for network installations only

This software is available only when the printer is connected to a network.

### HP Web Jetadmin

HP Web Jetadmin is intended for printer management in commercial and enterprise networks. While the embedded Web server is used to manage a single printer, HP Web Jetadmin is used to manage groups of printers and other devices. Download this software from the HP website at <http://www.hp.com/go/webjetadmin>. The HP Web Jetadmin website provides HP Web Jetadmin software in many languages.

HP Web Jetadmin is available only if the printer is connected to an IP-based network. This browser-based software can be installed on one of the following supported platforms:

- Microsoft Windows NT 4.0 or 2000
- HP-UX
- Sun Solaris
- Red Hat Linux
- SuSE Linux

### Starting HP Web Jetadmin

Once you install the HP Web Jetadmin software, you can start it in a supported Web browser on any computer by typing one of the following URLs:

- `http://server.domain:port/`  
where “server.domain” is the server hostname and “port” is the port number that you entered during installation. (The default port is 8000.) This information is available in the url.txt file, which is stored in the folder where HP Web Jetadmin is installed.
- `http://ipaddress:port/`  
where “ipaddress” is the IP address of the computer where HP Web Jetadmin is located.

For settings that appear in both the printer driver and HP Web Jetadmin, changes made in the printer driver override changes made in HP Web Jetadmin.

## Software for Macintosh

For Mac OS 8.6 to 9.x, the Apple LaserWriter 8 driver must be installed to use the PPD file. Use the Apple LaserWriter 8 driver that came with your Macintosh. For Mac OS X, use Print Center to print.

The printer includes the following software for Macintosh computers.

### **PPDs (Mac OS 8.6 to 9.x and Mac OS X classic)**

PPDs, in combination with the LaserWriter driver, provide access to the printer features and allow the computer to communicate with the printer. An installation program for the PPDs is provided on the HP Color LaserJet 2500 CD-ROM.

### **PDEs (Mac OS X)**

PDEs are code plug-ins that provide access to printer features, such as number of copies, duplexing, and quality settings. An installation program for the PDEs and other software is provided on the HP Color LaserJet 2500 CD-ROM.

### **Embedded Web server**

When the printer is connected to the network, the embedded Web server is supported for Windows 95 and later, Mac OS 8.6 and later, UNIX, Linux, and OS/2.

With the embedded Web server, you can gain access to the printer settings and information by typing an IP address in a Web browser (such as Netscape Navigator or Microsoft Internet Explorer) on any computer. You can use the embedded Web server to configure the printer and view status information, as well as view a textual message regarding what a Status light message on the printer means. See [“Managing the printer” on page 55](#) for more information.

### How do I gain access to printer features?

Printer features are available in the printer driver. Some features such as custom paper sizes and page orientation might also be available in the program you are using to create a file. Change settings in the program, if possible, because changes made in the program override changes made in the printer driver.

Gain access to advanced printer features from the printer driver (or the **Print** dialog box for Macintosh). See “[Gaining access to printer driver settings](#)” on page 37 for help with specific printer-driver features.

### How do I get the latest printing software?

When you want to check for and install upgrades to the printing software, you can download drivers from the World Wide Web or HP’s FTP servers.

### To download drivers

- 1 Visit <http://www.hp.com>. In the **Select your country or region** field in the top, right corner, select your country/region and click .
- 2 Click the **Drivers** block, and then enter `color laserjet 2500` as the product name. The Web page for the drivers might be in English, but you can download the drivers themselves in several languages.

If you do not have Internet access, contact HP Customer Care. (See “[HP Customer Care](#)” on page 3 or the flyer that came in the printer box.) See the Readme file for additional release information.

### What other software is available?

See the Readme file provided on the HP Color LaserJet 2500 CD for additional software included and for supported languages.

# Uninstalling the printing software

Uninstall software using the directions below for your operating system.

## Uninstalling software for Windows

The printer comes with an uninstall utility that you can use to select and remove any or all of the Windows HP printing system components from your computer.

### To uninstall software for Windows 95

- 1 On the **Start** menu, point to **Settings**, and click **Printers**.
- 2 Select the icon for this printer and on the **File** menu, click **Delete**.

### To uninstall software for Windows 98 and higher

---

**Note**

To uninstall the software from Windows NT 4.0, 2000, or XP, you must log on with administrator privileges.

- 1 Close all open programs.

#### For Windows 98 and Me:

- a Press **CTRL+ALT+DELETE**. The **Close Program** dialog box opens.
- b Select a program *except* Explorer or Systray and click **End Task**.
- c Repeat step b until all programs except Explorer and Systray are closed.

#### For Windows NT 4.0, 2000, and XP:

- a Press **CTRL+ALT+DELETE**. The Windows NT Security dialog box opens.
  - b Click **Task Manager** and then click the **Applications** tab.
  - c Select a program and click **End Task**.
  - d Repeat step c until all programs are closed.
- 2 On the **Start** menu, point to **Programs**, point to **HP Color LaserJet 2500**, point to **Tools**, and click **Uninstall**.
  - 3 Click **Next**, select the HP printing system components that you want to uninstall, and click **OK**.
  - 4 Follow the directions on the screen. When the message "The following file is a shared file but is not used by any other programs. Would you like to delete it?" appears, click Yes to All. The system finishes removing files.
  - 5 If prompted to restart the computer, click **OK**.



## Uninstalling software for Macintosh

To remove the printing software from your Macintosh, drag the HP LaserJet folder and PPDs to the Trash.

*For Mac OS 8.6 to 9.x:* The PPDs are located here:  
Macintosh HD\System Folder\Extensions\Printer Descriptions.

*For Mac OS X:* The PPDs are located here:  
Macintosh HD/Library/Printers/PPDs/Contents/Resources/<lang>.lproj.

The phrase <lang> represents the language of the printer software you chose.

## Accessories and ordering information

The following list of accessories was current at the time of printing. Ordering information and availability of the accessories might change during the life of the printer. For the most current ordering information, visit:

- North America: <http://www.hp.com/go/ordersupplies-na>
- Europe & Middle East: <http://www.hp.com/go/ordersupplies-emea>
- Asia Pacific countries/regions: <http://www.hp.com/go/ordersupplies-ap>
- Latin America: <http://www.hp.com/go/ordersupplies-la>

Option	Description or use	Part number
<b>Supplies</b>		
Black print cartridge	Life of 5,000 pages at 5% coverage	C9700A
Cyan print cartridge	Life of 4,000 pages at 5% coverage	C9701A
Yellow print cartridge	Life of 4,000 pages at 5% coverage	C9702A
Magenta print cartridge	Life of 4,000 pages at 5% coverage	C9703A
Imaging drum	Imaging drum life is 20,000 pages if printing black only; 5,000 pages if printing in color. Approximate life is 6,000 to 8,000 pages.	C9704A
<b>Memory</b>		
Memory upgrades (DIMMs)	The standard 64 MB of memory in the printer can be expanded to up to 256 MB using the two additional DIMM slots. <ul style="list-style-type: none"> <li>● 32 MB</li> <li>● 64 MB</li> <li>● 128 MB</li> </ul>	C7845A C7846A C9121A
Font DIMM (100-pin)	You can install an 8-MB language font ROM in one of the DIMM slots.	Visit <a href="http://www.hp.com">http://www.hp.com</a> for DIMM availability and ordering.
<b>Cable and interface accessories</b>		
HP Jetdirect print server cards	HP Jetdirect print server cards: <ul style="list-style-type: none"> <li>● HP Jetdirect 680n Wireless Networking (802.11b)</li> <li>● HP Jetdirect 600n Ethernet (10 Base-T, RJ-45 only)</li> <li>● HP Jetdirect 600n Ethernet (10 Base-T RJ-45, 10Base2 BNC)</li> <li>● HP Jetdirect 615n Ethernet/Fast Ethernet (10/100 Base-TX, RJ-45 only)</li> </ul> <b>Note:</b> This print server card comes with the HP Color LaserJet 2500n and 2500tn printers. <ul style="list-style-type: none"> <li>● HP Jetdirect 610n Token Ring (RJ-45, DB-9)</li> <li>● HP Jetdirect connectivity card for USB, Serial, and LocalTalk connections</li> </ul>	J6058A J3110A J3111A J6057A J4167A J4135A
Parallel cables (IEEE-1284)	<ul style="list-style-type: none"> <li>● 2-meter, size B</li> <li>● 3-meter, size B</li> </ul>	C2950A C2951A
USB cable	2-meter standard USB-compatible device connector	C6518A CPC
Connectivity accessories	MPI Tech Bluetooth printer adapter	Available at <a href="http://www.hp.com">http://www.hp.com</a>
<b>Paper handling accessories</b>		
Optional tray 2	250-sheet input tray for letter and A4 sizes. Only one 250-sheet tray can be installed. <b>Note:</b> This tray is included with the 2500, 2500n, and 2500tn models.	C9698A

Option	Description or use	Part number
Optional tray 3	500-sheet input tray for letter and A4 sizes. Only one 500-sheet tray can be installed. You <i>must</i> have a 250-sheet optional tray 2 installed to install an optional tray 3. <b>Note:</b> This tray is included with the 2500tn model.	C9699A
<b>Paper and other print media</b>		
HP LaserJet paper	Premium HP-brand paper for use with HP LaserJet printers.	HPJ1124 (letter) CHP310 (A4) HPJ1424 (legal)
HP Premium Choice paper	HP bond paper with a weight of 120.32 g/m <sup>2</sup> (32 lb.)	HPU1132 (letter) CHP410 (A4)
HP Printing paper	HP-brand paper for use with HP LaserJet printers.	HPP1122 (letter) CHP210 (A4)
HP Multipurpose paper	HP-brand paper for a variety of uses.	HPM1120 (letter) HPM1420 (legal)
HP LaserJet Tough paper	Robust paper with a satin finish. Paper will not tear and will withstand the weather. For documents requiring durability and longevity.	Q1298A (letter) Q1298B (A4)
Grayscale transparencies	The printer supports printing <i>in grayscale</i> on grayscale or color transparencies. Grayscale transparencies are usually less expensive.	92296T (letter) 92296U (A4)
<b>Extended service packs</b>		
Contact HP Customer Care for availability and for ordering.		
<b>User-replaceable parts</b>		
Fuser	Replace when print-quality issues remain after you have cleaned the engine and tried all troubleshooting measures. (See “Cleaning the printer” on page 99 and “Solving print-quality problems” on page 80.)	Contact HP Customer Care to order parts.
Separation pad and pick-up rollers	Replace when the printer is picking up multiple sheets or no sheets. Trying different paper did not resolve the problem.	Contact HP Customer Care to order parts.
<b>Supplementary Documentation</b>		
<i>HP LaserJet Printer Family Print Media Guide</i>	A guide to using paper and other print media with HP LaserJet printers.	5963-7863
<i>HP Color LaserJet 2500 series printer user guide</i>	A printed copy of this user guide.	
	<ul style="list-style-type: none"> <li>● English</li> <li>● Chinese, simplified</li> <li>● Chinese, traditional</li> <li>● Czech</li> <li>● Danish</li> <li>● Dutch</li> <li>● Finnish</li> <li>● French</li> <li>● German</li> <li>● Italian</li> <li>● Korean</li> <li>● Norwegian</li> <li>● Portuguese, Brazilian</li> <li>● Polish</li> <li>● Russian</li> <li>● Spanish, Castilian</li> <li>● Swedish</li> <li>● Turkish</li> </ul>	C9706-90960 C9706-90977 C9706-90976 C9706-90973 C9706-90967 C9706-90966 C9706-90968 C9706-90961 C9706-90963 C9706-90962 C9706-90975 C9706-90969 C9706-90965 C9706-90972 C9706-90971 C9706-90964 C9706-90970 C9706-90974
<i>HP Color LaserJet 2500 series printers CD-ROM</i>	Visit <a href="http://www.hp.com/support/cij2500">http://www.hp.com/support/cij2500</a> to find the CD-ROM part number.	



# 2 Printing tasks

## Introduction

This section provides information about common printing tasks.

- “Choosing paper and other print media” on page 28
- “Loading trays” on page 31
- “Printing a job” on page 34
- “Choosing an output location” on page 42
- “Printing on special print media” on page 43
- “Printing on both sides (duplexing manually)” on page 48
- “Canceling a print job” on page 49
- “Using color” on page 50

For information about managing the printer and its settings using the embedded Web server, the HP Color LaserJet 2500 Toolbox, and Printer Status and Alerts, see [“Managing the printer” on page 55](#).

## Choosing paper and other print media

The printer models come with input trays as specified below.

- The 2500L comes with one input tray (tray 1). You can add one optional tray 2 (250-sheets) and one optional tray 3 (500-sheets). Optional tray 2 must be installed to install optional tray 3.
- The 2500 and 2500n models come with two input trays (tray 1 and tray 2) standard. You can add one optional tray 3 (500-sheets).
- The 2500tn comes with three input trays (tray 1, tray 2, and tray 3).

Because tray 2 and tray 3 are not included for all models, they will be referred to as optional tray 2 and optional tray 3 in this documentation.

By default, the printer draws first from tray 1. If tray 1 is empty, the printer draws from optional tray 3 (if installed) and then optional tray 2, in that order.

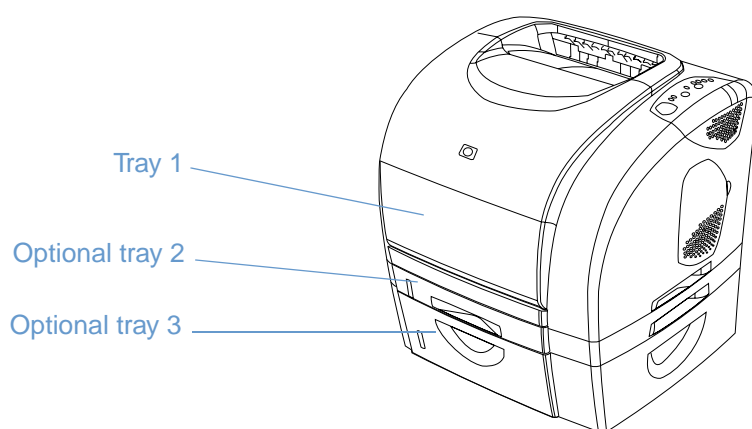

## Supported print media for tray 1

Tray 1 holds up to 125 sheets of paper or up to 10 envelopes. See [“Loading tray 1” on page 31](#).

### Supported sizes

Tray 1 adjusts for sizes from 76 by 127 mm (3 by 5 inches) to a legal-size sheet of 216 by 356 mm (8.5 by 14 inches).

See [“Tray specifications” on page 125](#) for specific dimensions.

### Supported types

Tray 1 supports these types of print media.

- Various types and weights of paper, including weights ranging from 60 to 177 g/m<sup>2</sup> (16 to 47 lb).
- Envelopes. See [“Printing on envelopes” on page 43](#).
- Labels. See [“Printing on labels” on page 44](#).
- Grayscale transparencies. See [“Printing on grayscale transparencies” on page 45](#).
- Custom-sized print media or cardstock. See [“Printing on custom-sized print media or cardstock” on page 46](#).
- Postcards. See [“Printing on custom-sized print media or cardstock” on page 46](#).

See [“Print media specifications” on page 123](#) for specific types and weights.

## Supported print media for optional tray 2

Optional tray 2 holds up to 250 sheets of paper. See [“Loading optional tray 2” on page 32](#).

---

### CAUTION

Load only paper in optional tray 2. Other types of print media, such as labels or grayscale transparencies, might jam if printed from optional tray 2.

### Supported sizes

- A4
- A5
- B5 (ISO and JIS)
- Letter
- Legal
- Executive
- 8.5 by 13 inches

See [“Tray specifications” on page 125](#) for specific dimensions.

### Supported types

- Various types of paper of average weight (60 to 105 g/m<sup>2</sup>, or 16 to 28 lb)
- Letterhead
- Prepunched paper
- Preprinted forms

See [“Print media specifications” on page 123](#) for specific types and weights.

## Supported print media for optional tray 3

Optional tray 3 holds up to 500 sheets of paper. See “Loading optional tray 3” on page 33.

---

### CAUTION

---

Load only paper in optional tray 3. Other types of print media, such as labels or grayscale transparencies, might jam if printed from optional tray 3.

### Supported sizes

- A4
- Letter

See “Tray specifications” on page 125 for specific dimensions.

### Supported types

- Various types of paper of average weight (60 to 105 g/m<sup>2</sup>, or 16 to 28 lb)
- Letterhead
- Prepunched paper

See “Print media specifications” on page 123 for specific types and weights.

## Purchasing paper and other print media

You can print on a variety of print media, such as heavy or light paper, envelopes, labels, and custom-sized print media from tray 1. You can print on standard-weight paper from all three trays. You can also print to paper that has up to 100 percent recycled fiber content. Properties such as weight, grain, and moisture content are important factors affecting printer performance and output quality. To achieve the best possible print quality, use only high-quality paper intended for color laser printers.

See “Print media specifications” on page 123 for more details.

*Always test a sample of paper before purchasing large quantities.* Your paper supplier should understand the requirements specified in the *HP LaserJet Printer Family Print Media Guide*. See “Print media specifications” on page 123 for more information. For ordering information, see “Supplementary Documentation” on page 25, or visit <http://www.hp.com/ljsupplies>.



## Loading trays

Load special print media such as envelopes, labels, and grayscale transparencies, in tray 1 only. Load only paper in optional tray 2 or optional tray 3.

1

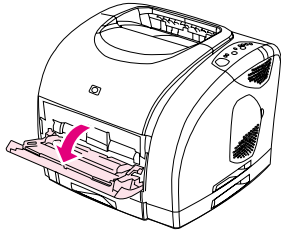

2

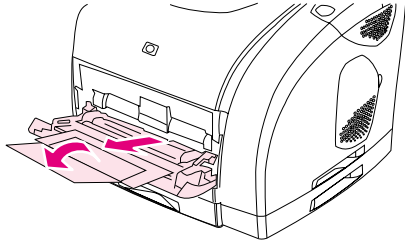

3

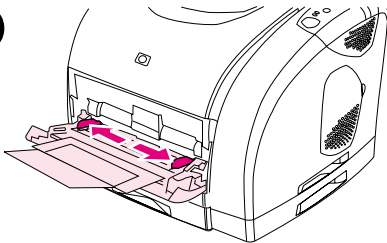

4

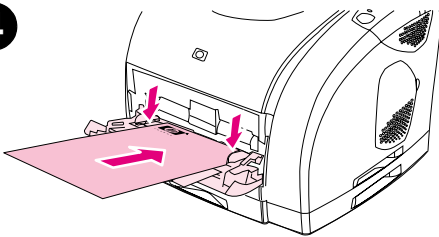

5

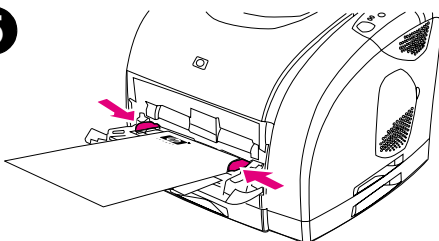

6

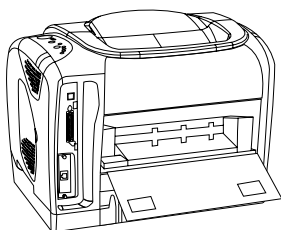

### Loading tray 1

Tray 1 (the multipurpose tray) holds up to 125 sheets of paper or other print media, or it holds up to 10 envelopes.

For information about loading special print media such as labels and grayscale transparencies, see [“Printing on special print media” on page 43](#).

#### To load tray 1

---

##### CAUTION

Avoid adding print media to tray 1 while the printer is printing, or jams can occur.

---

- 1 Open tray 1.
- 2 Slide out the tray extender. If the print media being loaded is longer than 229 mm (9 inches), also open the additional tray extender.
- 3 Slide the width guides slightly wider than the print media.
- 4 Place print media into the tray with the side to be printed up, and the top, short edge in first.

---

##### Note

If you are manually duplexing, see [“Printing on both sides \(duplexing manually\)” on page 48](#) for loading instructions.

---

- 5 Slide the paper width guides inward until they lightly touch the print media stack on both sides without bending it. Make sure the print media fits under the tabs on the width guides.

---

##### CAUTION

Wait for the printer to finish printing before closing tray 1 (optional). Closing the tray before the printer finishes can cause jams.

---

- 6 On the back of the printer, lower the rear output door if you are printing on special media, such as labels, envelopes, or heavy or light paper, to prevent curl.

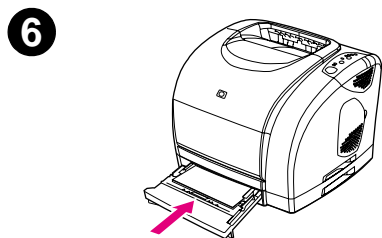
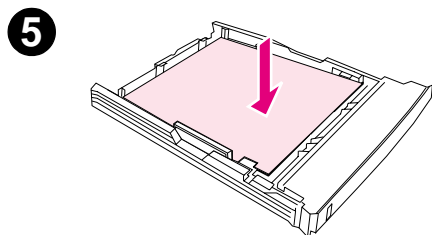
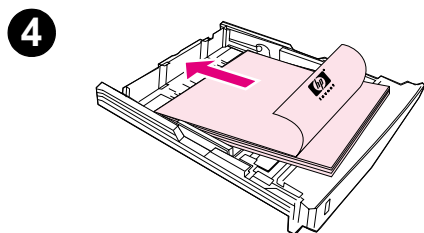
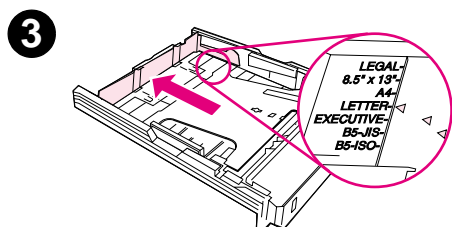
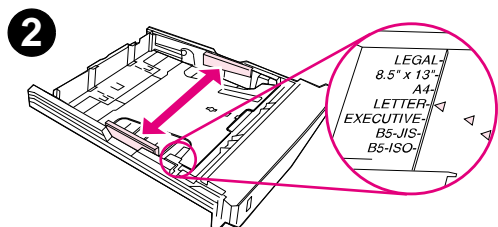
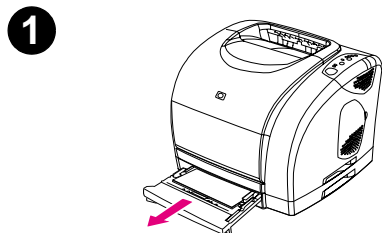

## Loading optional tray 2

Optional tray 2 supports standard-size paper only. Paper includes average-weight letterhead and prepunched paper. For additional information about letterhead and prepunched paper, see [“Printing on letterhead or preprinted forms”](#) on page 47.

### CAUTION

Print special print media such as labels and grayscale transparencies from tray 1 only. Printing special print media from optional tray 2 or optional tray 3 can cause jams.

### To load optional tray 2

- 1 Pull optional tray 2 out of the printer and remove any paper.
- 2 Move the side width guides to match the size of paper you are loading.
- 3 Extend the rear of the tray until the arrow on the markings points to the size you are loading.
- 4 Load the paper. If this is special paper such as letterhead, load it with the side to be printed down and the top edge toward the front of the tray.

### Note

If you are manually duplexing, see [“Printing on both sides \(duplexing manually\)”](#) on page 48 for loading instructions.

- 5 Make sure the stack of paper is flat in the tray at all four corners, and keep it below the height tabs on the paper length guide in the rear of the tray. Push down on the metal paper lift plate to lock it into place.
- 6 Slide the tray back into the printer. If you set the rear of the tray to one of the longer sizes, the back of the tray will protrude from the back of the printer.

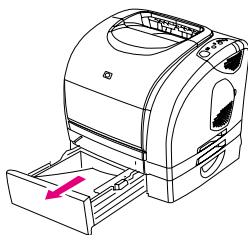
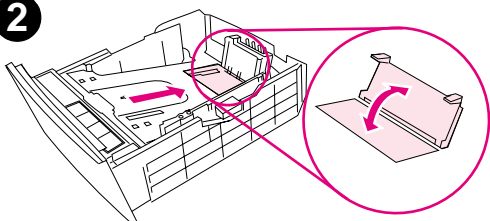
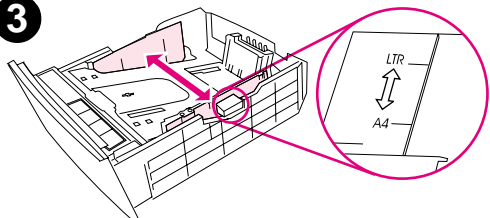
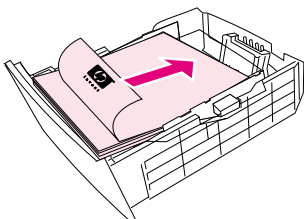
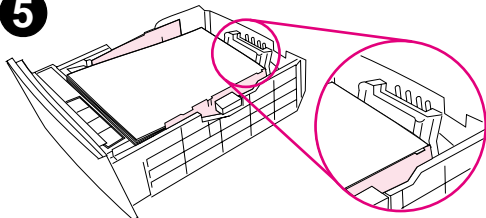
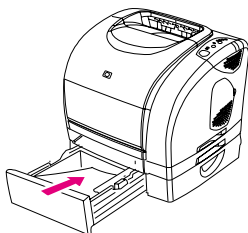
**1****2****3****4****5****6**

## Loading optional tray 3

The optional tray 3 supports A4- and letter-size paper. Optional tray 3 supports only paper, but paper includes average-weight letterhead and prepunched paper.

For additional information about letterhead and prepunched paper, see [“Printing on letterhead or preprinted forms” on page 47.](#)

---

### CAUTION

Print special print media such as labels and grayscale transparencies from tray 1 only. Printing special print media from optional tray 2 or optional tray 3 can cause jams.

---

### To load optional tray 3

- 1 Pull the tray out of the printer and remove any paper.
- 2 For letter-size paper, pull the rear stop up. For A4-size paper, push the rear stop down.
- 3 For letter-size paper, move the side width guides outward as far as possible. For A4-size paper, move the side width guides inward as far as possible.
- 4 Load the paper. If this is special paper such as letterhead, load it with the side to be printed down and the top edge toward the front of the tray.

---

### Note

If you are manually duplexing, see [“Printing on both sides \(duplexing manually\)” on page 48](#) for loading instructions.

---

- 5 Make sure the stack of paper is flat in the tray at all four corners, and keep it below the height tabs on the length guide in the rear of the tray.
- 6 Slide the tray back into the printer.

## Printing a job

This section provides basic printing instructions. When making changes to printing settings, there is a hierarchy to how changes are prioritized. (Note that the names of commands and dialog boxes might vary depending on your program.)

- *“Page Setup” dialog box.* This dialog box opens when you click **Page Setup** or a similar command on the **File** menu. This dialog box is part of the program in which you are working. *Settings changed here override settings changed anywhere else.*
- *“Print” dialog box.* This dialog box opens when you click **Print**, **Print Setup**, or a similar command on the **File** menu. It is also part of the program, but it has a lower priority than the **Page Setup** dialog box. Settings changed in the **Print** dialog box *do not* override settings changed in the **Page Setup** dialog box. Settings changed here *do* override settings changed in the printer driver.
- *Printer driver.* The printer driver opens when you click **Properties** in the **Print** dialog box. Settings changed here *do not* override settings changed anywhere else. (For Macintosh, the printer driver settings are integrated into the **Print** dialog box.)

### About printing by Source versus by Type or Size

Three settings affect how the printer driver tries to pull paper when you send a print job. These settings, *Source*, *Type*, and *Size*, appear in your program **Page Setup** dialog box, the **Print** dialog box, or the printer driver. The printer automatically selects a tray if you do not change these settings. If you do want to change these settings, you can print by *Source*, by *Type*, by *Size*, or by *Type* and *Size*. (For Macintosh, types and sizes are both available from the **Paper Source** pop-up menu.)

- *Source.* Printing by *Source* means you choose a specific tray from which you want the printer to pull paper. The printer tries to print from this tray, no matter what type or size is loaded in it. However, if you choose a tray that is configured from the embedded Web server for a type or size that does not match your print job, the printer does not print automatically. Instead, it waits for you to load the tray you chose with the type or size of print media for your print job. If you load the tray, the printer begins printing. (If it does not begin, you might need to configure the tray to match the size or type of the print job.) Or, press  (Go) to have the printer try to print from another tray.
- *Type or Size.* Printing by *Type* or *Size* means you want the printer to pull paper or print media from the first tray that is loaded with the type or size that you choose. *Always print by Type for special print media such as labels or grayscale transparencies.*
  - If you want to print by Type or Size and the trays have not been configured for a certain type or size from the embedded Web server, load the paper or print media into tray 1 and then select the Type or Size from the **Page Setup** dialog box, the **Print** dialog box, or the printer driver.
  - If you often print on a certain type or size of media, the printer administrator (for a network printer) or you (for a directly connected printer) can use the embedded Web server to configure a tray for that type or size. (See [“Using the embedded Web server” on page 60.](#)) Then, when you choose that Type or Size as you print a job, the printer pulls from the tray configured for that type or size.

## To print from Windows

- 1 Make sure paper is loaded in the printer.
- 2 On the **File** menu, click **Page Setup** or a similar command. Ensure that the settings are correct for this document.
- 3 From the **File** menu, click **Print**, **Print Setup**, or a similar command. The **Print** dialog box opens.
- 4 Select this printer and change any settings that you need. Do not change any settings, such as page size or orientation, that you set in the **Page Setup** dialog box.
- 5 If this print job is for a standard size and weight of paper, you probably do not need to change the **Source is** (tray), **Type is**, or **Size is** settings, and you can go to step 7. Otherwise, go to the next step.
- 6 If this print job is to be printed on a non-standard size or weight of paper, choose how the printer selects paper.
  - To print by Source (tray), select the tray in the **Print** dialog box, if possible.
  - To print by Source (tray) when this setting is not available in the **Print** dialog box, click **Properties** and on the **Paper** tab, select the tray in the **Source is** field.
  - To print by Type or Size, click **Properties** and on the **Paper** tab, select type or size in the **Type is** or **Size is** field. (For some paper such as letterhead, you will set both the Type and Size.) *Always print by Type for special print media such as labels or grayscale transparencies.*
- 7 If you have not yet done so, click **Properties**. The printer driver opens.
- 8 On the various tabs, set any settings that you want that did not appear in the **Page Setup** or **Print** dialog box. For more information about printer-driver settings, see [“Features in the printer driver” on page 38](#).
- 9 By default, the printer prints to the top output bin, which is the best location for most print jobs, including grayscale transparencies. For labels, heavy paper, or other special print media, lower the rear output door on the printer.
- 10 Select the **Print** command to print the job.

## To print from Macintosh

- 1 Make sure paper is loaded in the printer.
- 2 On the **File** menu, click **Page Setup**.
- 3 Make sure that this printer is selected in the **Format for** pop-up menu.
- 4 Select the size of paper onto which you are printing.
- 5 Select the **Orientation** and **Scale**, if necessary, and click **OK**.
- 6 On the **File** menu, click **Print**.
- 7 Select the Source (tray) from which you want to print or select the Type of media onto which you want to print in one of these ways. *Always print by Type for special print media such as labels or grayscale transparencies.*
  - **Mac OS 8.6 to 9.x:** On the **General** pop-up menu, select the tray or type of media from the **Page Source** pop-up menu.
  - **Mac OS X:** On the **Paper Feed** pop-up menu, select the tray or type of media.
- 8 Set any other settings you want, such as watermarks. (For more information, see [“Gaining access to printer driver settings” on page 37.](#))
- 9 By default, the printer will print to the top output bin, which is the best location for most print jobs, including grayscale transparencies. For labels, heavy paper, or other jobs requiring a straight-through path, lower the rear output door on the printer.
- 10 Select the **Print** command to print the job.

## Gaining access to printer driver settings

This section lists the common printing features that are controlled through the printer driver. (The printer driver is the software component you use to send print jobs to the printer.) You can change settings temporarily for the print jobs that you print while the program is still open. You can also make permanent changes to the default settings that will be in effect now and in the future.

Operating System	Temporarily change settings for jobs printed now	Permanently change default settings*
Windows 95, 98, NT 4.0, 2000, Me, and XP	From the <b>File</b> menu, click <b>Print</b> , select this printer, and then click <b>Properties</b> . (The actual steps can vary; this is the most common method.)	Click <b>Start</b> , point to <b>Settings</b> , and then click <b>Printers</b> or <b>Printers and Faxes</b> . Right-click the printer icon, and choose <b>Properties</b> . Many features are available by choosing the <b>Document Defaults</b> command (NT 4.0) or the <b>Printing Preferences</b> command (2000 and XP) instead.
Mac OS 8.6 to 9.x	On the <b>File</b> menu, click <b>Print</b> . Change settings that you want on the various pop-up menus.	On the <b>File</b> menu, click <b>Print</b> . As you change settings on a pop-up menu, click <b>Save Settings</b> .
Mac OS X	On the <b>File</b> menu, click <b>Print</b> . Change settings that you want on the various pop-up menus.	On the <b>File</b> menu, click <b>Print</b> . Change settings that you want on the various pop-up menus, and then on the main pop-up menu, click <b>Save Custom Settings</b> . These settings are saved as the <b>Custom</b> option. To use the new settings, you must select the <b>Custom</b> option every time you open a program and print.
UNIX, Linux, and OS/2	Some features of the printer driver are available from the embedded Web server, if the printer is connected to the network. (See <a href="#">“Using the embedded Web server”</a> on page 60.)	

\* Access to default printer settings might be restricted and therefore unavailable.

### Using the PCL printer-driver Help (Windows only)

Once you are in the printer driver, you can use its Help, which is separate from the Help in a program. You can activate Help for the printer driver in two ways.

- Click the **Help** button anywhere it appears in the printer driver. The Help windows give detailed information about the specific printer driver in use.
- When you see a , click it to view information regarding the field, option, or button that the bubble adjoins.

## Features in the printer driver

Some printer drivers and some operating systems do not support all printer features. Use the PCL 6 printer driver to take full advantage of all the printer features, as listed below. The Windows directions in the following sections assume that you are using the PCL driver. In the PS driver, the tabs are named differently.

- Selecting a Source
- Selecting a Type or Size
- Setting a custom paper size
- Printing in grayscale
- Changing color settings
- Creating and using watermarks
- Printing multiple pages on one sheet of paper (N-up printing)
- Creating and using Quick Sets
- Reducing or enlarging
- Printing on different paper for the first page
- Changing print quality
- Restoring default printer-driver settings

For manual duplexing, see “[Printing on both sides \(duplexing manually\)](#)” on page 48.

### Selecting a Source

You can print by Source (tray) or by Type or Size. To print by Source, follow these steps. For more information, see “[About printing by Source versus by Type or Size](#)” on page 34. For Macintosh, types and sizes are all grouped together under the **Paper Source** pop-up menu.

- **Windows:** From the **Print** dialog box in your program, select the Source (tray), if possible. Otherwise, choose a tray from the **Source is** field from the **Paper** tab in your printer driver.
- **Mac OS 8.6 to 9.x:** From the **Print** dialog box, choose a tray from the **Paper Source** pop-up menu on the **General** pop-up menu.
- **Mac OS X:** From the **Print** dialog box, select the tray or type of media from the **Paper Feed** pop-up menu.

### Selecting a Type or Size

You can print by Source (tray) or by Type or Size. If you are printing to special print media, such as heavy paper, it is important to print by Type to achieve good results. To print by Type or Size, follow these steps. For more information, see “[About printing by Source versus by Type or Size](#)” on page 34. For Macintosh, types and sizes are all grouped together under the **Paper Source** pop-up menu.

- **Windows:** From the printer driver, choose a type in the **Type is** field of the **Paper** tab. Or, choose a size from the **Size is** field. For some paper, such as letterhead, you will choose a type and size.
- **Mac OS 8.6 to 9.x:** From the **Print** dialog box, choose a type from the **Paper Source** pop-up menu on the **General** pop-up menu.
- **Mac OS X:** From the **Print** dialog box, select the tray or type of media from the **Paper Feed** pop-up menu.



## Setting a custom paper size

Use the Custom Paper feature to set up the printer to print to sizes other than standard ones.

- **Windows:** Try to set this setting from *one* of these locations, in this order: the **Page Setup** dialog box in the program, the **Print** dialog box in the program, or the **Paper** tab in the printer driver.
- **Mac OS:** Gain access to Custom Paper features from the **Page Setup** dialog box. From the **Page Attributes** pop-up menu, select **Custom Page Size**.

## Printing in grayscale

If you have a document that you created in color, it will automatically print in color. Or, you can set the printer to print a color document in grayscale (black and white) only.

- **Windows:** Select the **Print In Grayscale** option on the **Color** tab of the printer driver.
- **Mac OS:** In the **Print** dialog box, select the **HP ColorSmart** or **HP Color Quality** pop-up menu and then select the **Print Color as Gray** option from the **Color Treatment** pop-up menu.

## Changing color settings

When you are printing in color, the printer driver automatically sets the optimal color settings for you. However, you can manually make adjustments to how the printer prints in color for text, graphics, and photographs. See [“Using color” on page 50](#) for more information.

- **Windows:** On the **Color** tab of the printer driver, click **Options**.
- **Mac OS:** In the **Print** dialog box, select the **HP ColorSmart** or **HP Color Quality** pop-up menu and then select the **Manual** option.

## Creating and using watermarks

The Watermark options allow you to specify that text be placed “underneath” (in the background of) an existing document. For example, you might want to have large gray letters reading “draft” or “confidential” placed diagonally across the first page or all pages of a document. You can change color, position, and wording of the watermark.

---

### Note

If you are using Windows NT 4.0, 2000, or XP, you must have Administrator privileges to create watermarks. You do not need Administrator privileges to add existing watermarks to documents.

- **Windows:** Gain access to the **Watermark** options from the **Effects** tab in your printer driver.
- **Mac OS:** Gain access to the Watermark options from the watermark/overlay pull-down menu in the **Print** dialog box. (Note that OS X might not support Watermarks.)

## Printing multiple pages on one sheet of paper (N-up printing)

N-up printing is the ability to print multiple pages on one sheet of paper. The pages will appear decreased in size. You can specify up to nine pages per sheet, and they will be arranged on the sheet as shown below if you use the default arrangement. You can also choose whether a border appears around each page or not.

- **Windows:** Gain access to **Pages per Sheet** on the **Finishing** tab in the printer driver.
- **Mac OS:** Gain access to Pages per sheet by choosing the **Layout** pop-up menu in the **Print** dialog box.

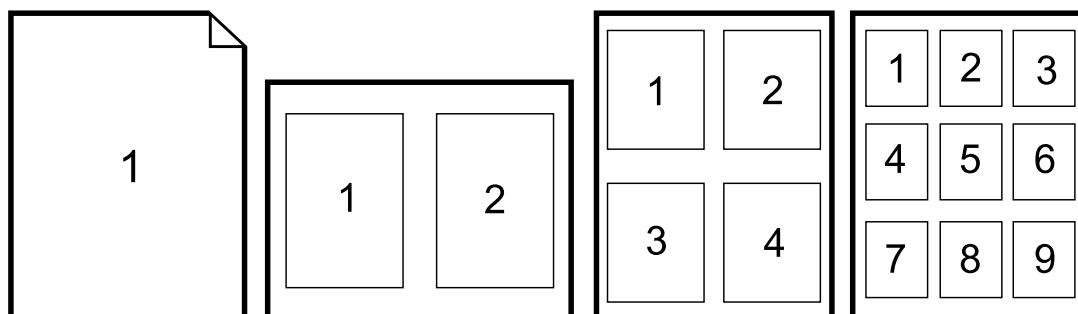

## Creating and using Quick Sets

Quick Sets allow you to save the current print-driver settings such as page orientation, N-up printing, or paper source for later use. You can save up to a total of 30 sets of settings. For convenience, Quick Sets can be selected and saved from most printer-driver tabs.

### Note

If you are using Windows NT 4.0 or Windows 2000, you must have Administrator privileges to save Quick Sets.

- **Windows:** Create Quick Sets from most printer-driver tabs. Later, you can gain access to Quick Sets from the **Finishing** tab in the printer driver.
- **Mac OS:** This feature is not supported.

## Reducing or enlarging

The **Fit to Page** option allows you to scale your document to a percentage of its normal size. You can also choose to scale your document to fit on any size of paper supported by the printer.

- **Windows:** Gain access to **Fit to Page** settings on the **Effects** tab in the printer driver.
- **Mac OS:** Gain access to Reduce and Enlarge (**Scale**) settings from the **Page Setup** dialog box.

## Printing on different paper for the first page

Printing on different paper for the first page is useful if you are printing a letter for example that uses letterhead on the first page and plain sheets for the subsequent pages. The *size* for all pages of the print job must be the same in the printer driver.

- **Windows:** Try to set this setting from *one* of these locations, in this order: the **Page Setup** dialog box in the program, the **Print** dialog box in the program, or the **Paper** tab in the printer driver.
- **Mac OS 8.6 to 9.x:** On the **General** pop-up menu in the **Print** dialog box, select the **First Page from** option. Then, select the source for the first page.
- **Mac OS X:** On the **Paper Feed** pop-up menu in the **Print** dialog box, select the **First Page from** option. Then, select the source for the first page.

## Changing print quality

The printer driver automatically chooses settings for your document to optimize the quality of the output. However, you can change these advanced settings, such as raster compression or scale patterns (WYSIWIG).

- **Windows:** Gain access to the Print Quality settings by clicking **Details** on the **Finishing** tab.
- **Mac OS:** This feature is not supported.

## Restoring default printer-driver settings

You can return all settings in the printer driver to their default values. This measure might be useful if you are experiencing quality issues, or if the paper is not being selected from the correct tray.

- **Windows:** Choose **Defaults** in the **Quick Sets** box from the **Finishing** tab of the printer driver.
- **Mac OS 8.6 to 9.x:** Drag the desktop printer icon to the Trash, and then set up the printer in the Chooser.
- **Mac OS X:** The Standard option contains the default settings and is automatically selected each time you open a program. Or, select it from the **Saved Settings** pop-up menu.

## Choosing an output location

The printer comes with the top output bin and a rear output door for printing to a straight-through paper path. Print jobs emerge from the top output bin when the rear output door is closed. Print jobs emerge from the back of the printer when the rear output door is open.

- Use the top output bin when printing most jobs, including jobs on average-weight paper and letterhead, as well as grayscale transparencies. The top output bin can hold up to 125 sheets. Prevent more than 125 sheets from accumulating in the top output bin, or jams can occur.
- Use the rear output door (straight-through paper path) when printing envelopes, labels, heavy- or light-weight paper, and other thick or special print media (except grayscale transparencies). Remove each sheet as it exits the printer.

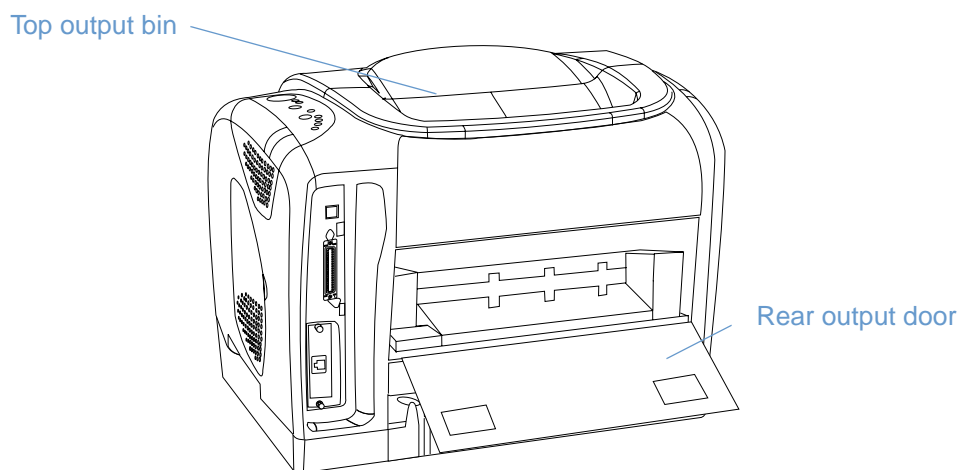

# Printing on special print media

Printing speeds might be automatically reduced when printing on any special-sized print media.

1

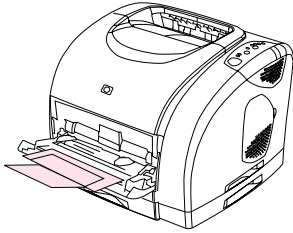

2

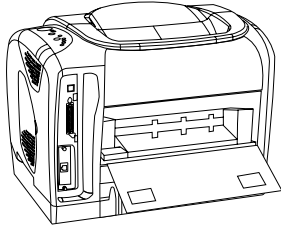

3

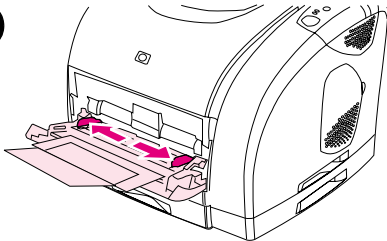

4

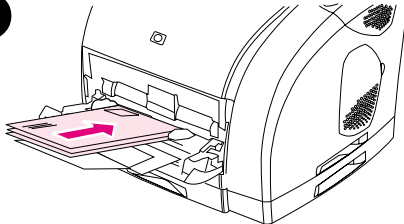

5

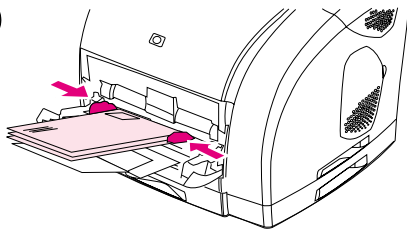

## Printing on envelopes

Load envelopes into tray 1 only.

- The weight of the envelope paper should not exceed 105 g/m<sup>2</sup> (24 lb).
- Make sure envelopes are undamaged and are not stuck together.
- Never use envelopes with clasps, snaps, windows, coated linings, self-stick adhesives, or other synthetic materials.
- If you are using a non-standard size of envelope, select the appropriate one as the Type.

---

### CAUTION

Failure to follow the guidelines above can result in jams.

---

For more information, see [“Print media specifications” on page 123](#).

## To print on envelopes

- 1 Open tray 1 and slide out the extender fully. If tray 1 is already open, remove any paper or other print media from it.
- 2 On the back of the printer, lower the rear output door to prevent the envelopes from curling.
- 3 Slide the width guides in tray 1 outward until they are slightly wider than the envelopes.
- 4 Place the stack of envelopes into the tray with the side to be printed up and the short edge in. The stamp end must enter the printer first.

---

### Note

If the envelope has a flap on a short edge, this edge must enter the printer first.

---

- 5 Slide the width guides inward until they lightly touch the stack without bending it. The stack should be centered between the guides and must be under the tabs on the guides.
- 6 Choose the envelope you are using as the Size (Windows) or the Paper Source (Macintosh) from the **Print** dialog box or the printer driver.

## Printing on labels

Follow the guidelines here for using labels. See [“Print media specifications” on page 123](#) for more details.

### CAUTION

To avoid damaging the printer, use only labels recommended for laser printers. To prevent serious jams, always use tray 1 to print labels and always use the straight-through paper path. Never print on the same sheet of labels more than once or print on a partial sheet of labels.

- Avoid labels that are separating from the backing sheet or are wrinkled or damaged in any way.
- Place labels only in tray 1 with the side to be printed up and the top, short edge in first.

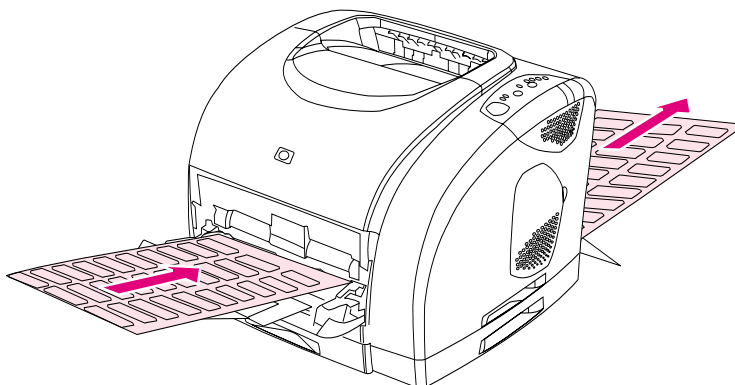

- Choose **Labels** as the Type (Windows) or the Paper Source (Macintosh) from the **Print** dialog box or the printer driver.
- Remove label sheets as they print from the straight-through paper path to prevent them from sticking together.
- If a sheet of labels jams in the printer, see [“Clearing jams” on page 66](#).

## Printing on grayscale transparencies

The printer supports printing *in grayscale* on grayscale or color transparencies. (Grayscale transparencies are usually less expensive.) See “[Grayscale transparencies](#)” on page 132 for more details.

---

### CAUTION

---

To avoid damaging the printer, use only transparencies recommended for laser printers. To prevent serious jams, always use tray 1 to print grayscale transparencies.

- Load grayscale transparencies into tray 1 only.

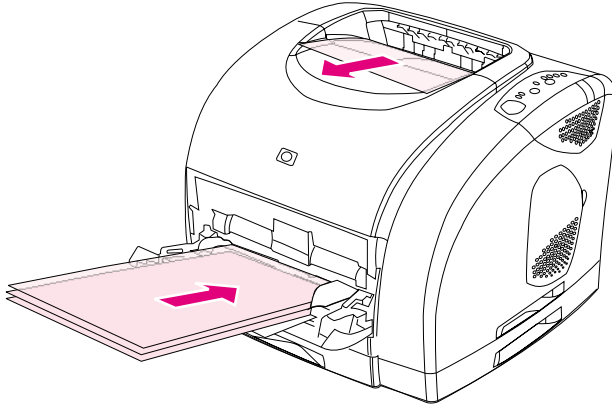

- Choose **Grayscale Transparencies** as the Type (Windows) or the Paper Source (Macintosh) from the **Print** dialog box or the printer driver.
- Use the top output bin to reduce curling. (This rule is for grayscale transparencies only. For other special print media, use the straight-through paper path to reduce curling.)
- To prevent grayscale transparencies from sticking together, remove each one from the top output bin as it prints.
- Place grayscale transparencies on a flat surface after removing them from the printer.

## Printing on custom-sized print media or cardstock

Postcards, 3-by-5-inch (index) cards, and other custom-sized print media can be printed from tray 1. The minimum size is 76 by 127 mm (3 by 5 inches) and the maximum size is 216 by 356 mm (8.5 by 14 inches).

- Always insert the short edge first into tray 1. To print in landscape mode, make this selection through your program. Inserting paper long edge first might cause a paper jam.
- In your program, set margins at least 6.4 mm (.25 inches) away from the edges of the print media.
- Choose the custom media you are using as the Type in the printer driver and set the correct Size.
- Lower the rear output door to use the straight-through paper path and reduce curl.

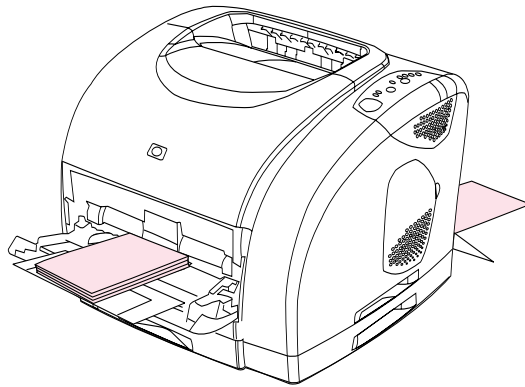

- See [“Print media specifications” on page 123](#) for more information.



## Printing on letterhead or preprinted forms

This section shows how to orient letterhead or preprinted forms when you are printing only on one side. For duplex (two-sided printing) orientation, see [“Printing on both sides \(duplexing manually\)” on page 48.](#)

- Orient paper as shown below.

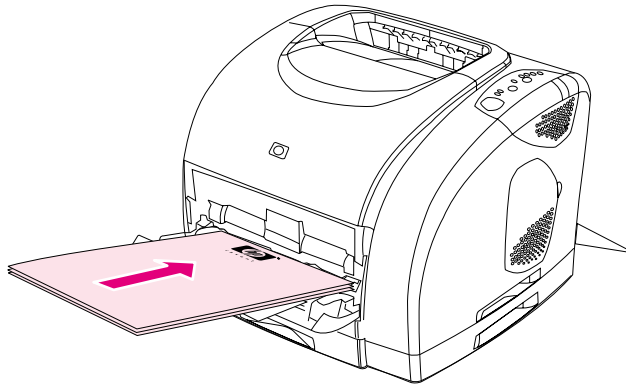

**Orientation of letterhead in tray 1: side to be printed up, top edge in first.**

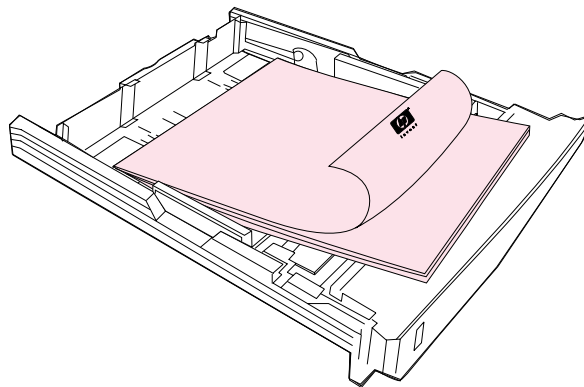

**Orientation of letterhead in tray 2 or optional tray 3: side to be printed down, top edge toward the front of the tray.**

- Lower the rear output door if the paper is heavy to reduce curl.
- Avoid raised or embossed letterhead.
- Avoid letterhead that is printed with low-temperature inks, such as those used in some types of thermography.
- The printer uses heat and pressure to fuse toner to the paper. Make sure that any colored paper or preprinted forms use inks that are compatible with this fusing temperature (195° C or 383° F for 0.1 second).

## Printing on both sides (duplexing manually)

To print on both sides of the paper, you will have to go to the printer and reinsert the paper manually after the first side has printed.

### CAUTION

Do not print on both sides of labels, transparencies, or vellum. Damage to the printer and jams might result.

### To duplex manually

- 1 Insert enough paper into one of the trays to accommodate the print job. If you are loading special paper such as letterhead, load it in one of these ways.
  - For tray 1, load the letterhead paper with the front side down, bottom in first.
  - For optional tray 2 and optional tray 3, load the letterhead paper with front side up, top edge toward the back of the tray.

Tray 1

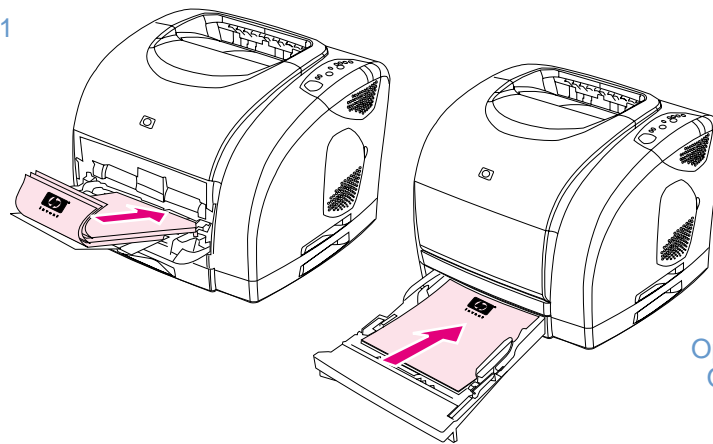

Optional tray 2 or  
Optional tray 3

- 2 In the printer driver, select the **Print on Both Sides** option and send the job to print.
- 3 After the job finishes printing, remove any blank paper from tray 1. Insert the printed stack, with the blank side up, top edge in *first*. You *must* print the second side from tray 1.

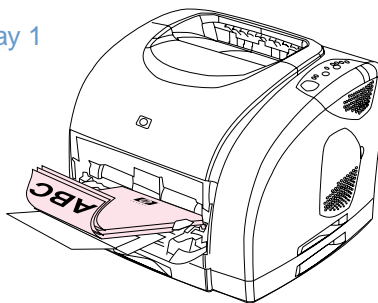

Tray 1



- 4 Press  (Go).

## Canceling a print job

A print job can be stopped from a program, from a print queue, or from the  (CANCEL JOB) button on the printer.

- If the printer has not started printing, first try to cancel the job within the program that sent the print job.
- If the print job is waiting in a print queue or print spooler such as the Printers group in Windows or Print Monitor or Print Center Queue (Mac OS), try to delete the job from there next.
- If the print job is already printing, press  (CANCEL JOB) on the printer. The printer finishes printing any pages that are already moving through the printer and deletes the remainder of the print job.
- Pressing  (CANCEL JOB) cancels only the current job in the printer. If more than one print job is in printer memory, you must press  (CANCEL JOB) once for each job after the job starts printing.

If the Printer Status lights continue to cycle after a job has been canceled, the computer is still sending the job to the printer. Either delete the job from the print queue or wait until the computer finishes sending data.

## Using color

This printer offers great color as soon as you set it up. It provides a combination of automatic color features to generate excellent color results for the general user, plus sophisticated tools for the experienced color user.

The printer provides carefully designed and tested color tables to provide smooth, accurate color rendition of all printable colors. The printer also offers these capabilities to help manage color:

- [HP ImageREt 2400](#)
- [HP ColorSmart](#)
- [Managing color options](#)
- [Matching colors](#)
- [Printing in four-colors \(CMYK\)](#)

### HP ImageREt 2400

HP ImageREt 2400 is a technology that provides you with the best color print-quality without having to change driver settings or make tradeoffs between print quality, performance, and memory. ImageREt 2400 produces sharp images and crisp, clear text using laser printing.

ImageREt 2400 provides 2400 dpi color laser-class quality through a multilevel printing process. This process precisely controls color by combining up to four colors within a single dot and by varying the amount of toner in a given area. As a result, ImageREt 2400, together with the 600-by-600 engine resolution, creates millions of smooth colors.

In contrast, the single-level printing process found in the default mode of other color laser printers does not allow the colors to be mixed within a single dot. This process, called dithering, significantly hinders the ability to create a wide range of colors without reduced sharpness or visible dot structure.

## HP ColorSmart

The Automatic color setting (HP ColorSmart) enables optimal color output automatically for diverse types of documents. This feature utilizes object tagging that allows optimal color and halftone settings to be used for different objects (text, graphics, and images) on a page. The printer driver analyzes which objects the page contains and uses halftone and color settings that provide the best print quality for each object.

### Managing color options

By default, the Color setting is set to Automatic, which is normally the best setting. However, if you have special color needs, you can change color settings. You can also set color documents to print in grayscale (black and white).

- **Windows:** These settings appear on the **Color** tab in the printer driver.
- **Mac OS:** These settings appear color area in the **Print** dialog box.

### Print in Grayscale

Selecting the **Print in Grayscale** option from your printer driver prints your document in grayscale. This option is useful for previewing preliminary copies of slides and hardcopy output quickly, or for color documents that will be photocopied or faxed.

### Automatic versus Manual color adjustment

You can allow the printer driver to select the best color options, or you can make adjustments yourself. Note that the names of options here might be different for Macintosh.

- **Automatic.** The **Automatic** option is the default setting and is recommended for printing all color documents. **Automatic** optimizes the neutral-gray color treatment, halftones, and edge enhancements used for text, graphics, and photographs in a document.
- **Manual.** The **Manual** option allows you to adjust the neutral-gray color treatment, halftones, and edge enhancements for text, graphics, and photographs. See [“Manual Options” on page 52](#) for descriptions of what the options do.

For more information, see the Help in the printer driver.

## Manual Options

If you select **Manual**, you can individually adjust the Halftoning, Neutral Grays, Edge Control, and RGB Color options for each of the major elements: text, graphics, and photographs.

### Halftone options

Halftone options affect the resolution and clarity of your color output. You can independently adjust halftone settings for text, graphics, and photos. The two halftone options are **Smooth** and **Detail**. If your program converts text and graphics to raster, the Photographic settings will also control text and graphics.

- **Smooth** provides better results for large, solid-filled print areas. It also enhances photos by smoothing out fine color gradations. Choose this option when uniform and smooth area fills are the most important attributes.
- **Detail** is useful for text and graphics that require sharp distinctions among lines or colors, or images that contain a pattern or a high level of detail. Choose this option when sharp edges and details are the most important attributes.

### Neutral Grays

Neutral Grays determines the method for creating neutral gray colors. If your program converts text and graphics to raster, the Photographic settings will also control text and graphics.

- **Black Only** generates neutral colors (grays and black) using only black toner. This option guarantees that neutral colors do not have a color cast.
- **4-Color** generates neutral colors by combining all four colors of toner. This option produces smoother gradients and transitions to non-neutral colors. It also produces the darkest possible black.

### Edge Control

This option determines how edges are rendered. Edge Control consists of two components: Adaptive Halftoning and Trapping. Adaptive Halftoning increases the edge sharpness. Trapping reduces the effect of color plane misregistration by slightly overlapping the edges of adjacent objects.

- **Maximum** provides the most trapping. Adaptive Halftoning is set to On.
- **Normal** provides the default trapping settings. Adaptive Halftoning is set to On.
- **Light** provides minimal trapping. Adaptive Halftoning is set to On.
- **Off** sets Trapping and Adaptive Halftoning to Off.

### RGB Color

This option determines how colors are rendered.

- **Default** interprets RGB color as sRGB, which is the accepted standard for many software companies and organizations, such as Microsoft and the World Wide Web Consortium.
- **Device** sets the printer to print RGB data in raw device mode. To render photographs properly when this option is selected, you must manage color in the program in which you are working or in the operating system.

## Matching colors

The process of matching printer output color to your monitor is quite complex because printers and computer monitors use different methods of producing color. Monitors *display* colors by light pixels using an RGB (red, green, blue) color process, but printers *print* colors using a CMYK (cyan, magenta, yellow, and black) process.

Several factors can influence your ability to match printed colors to those on your screen. These factors include:

- Print media
- Printer colorants (toner)
- Printing process (inkjet, press, or laser technology for example)
- Overhead lighting
- Programs
- Printer drivers
- Computer operating system
- Monitors
- Video cards and drivers
- Operating environment, such as it is very humid or very dry
- Personal differences in perception of color

Keep in mind the above factors when colors on your screen do not perfectly match your printed colors. For most users, the best method for matching colors on your screen to your printer is to print sRGB colors. The printer uses sRGB and automatically optimizes color output.

For more information about solving issues related to color output, see [“Problem solving and maintenance” on page 65](#).

## Printing in four-colors (CMYK)

Cyan, magenta, yellow, and black (CMYK) are the inks used by a printing press. The process is often called four-color printing. CMYK data files are typically used by and originate from graphic arts (printing and publishing) environments. The printer will accept CMYK colors through the PS printer driver. The printer color-rendering of CMYK is designed to provide rich, saturated colors for text and graphics.





# 3

## Managing the printer

### Introduction

This printer comes with several software tools that help you monitor, troubleshoot problems with, and maintain the printer. The software tools are:

- “Special pages” on page 56
- “HP Color LaserJet 2500 Toolbox” on page 58
- “Using the embedded Web server” on page 60
- “Using Printer Status and Alerts” on page 63

## Special pages



Special pages reside within the memory of the printer. These pages help you to diagnose and solve problems with the printer.

**Note** If the printer language was not correctly set during installation, you can set the language manually so that the pages print in one of the supported languages. Change the language using the embedded Web server (“[Using the embedded Web server](#)” on page 60) or HP Web Jetadmin.

### Demo page

To print the Demo page, press  (Go) when the printer is Ready (Ready light on) and not printing. You can also view this page from the HP Color LaserJet 2500 Toolbox.

### Configuration page

The Configuration page lists current settings and properties of the printer. You can print a Configuration page from the printer, the embedded Web server, or the HP Color LaserJet 2500 Toolbox. To print the Configuration page from the printer, press  (Go) and  (CANCEL JOB) simultaneously. (The Supplies Status page also prints. If you have an HP Jetdirect print server card installed, the HP Jetdirect page listing the HP Jetdirect information prints as well.)

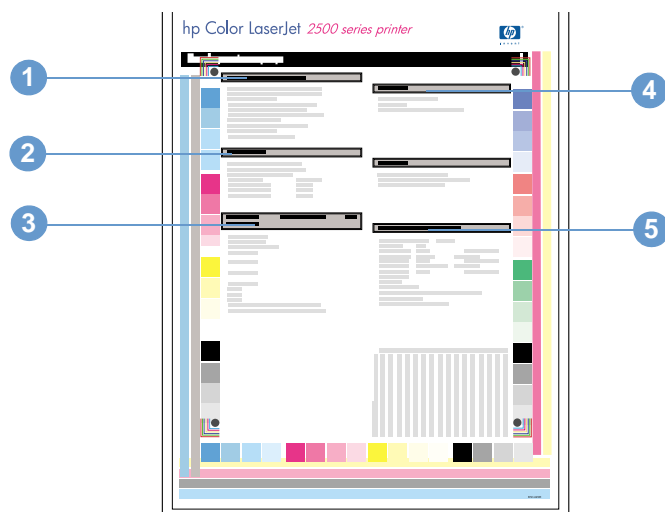

- 1 Printer Information.** This section contains basic information about the printer, such as the product name, printer name, and page count.
- 2 Event Log.** This section contains information about printer errors.
- 3 Installed personalities and options.** This section contains information about optional items that might be installed, such as DIMMs or an HP Jetdirect print server card.
- 4 Memory.** This section lists memory-related information, such as the total memory installed.
- 5 Paper Tray Information.** This section contains information about the trays, such as whether optional trays are installed, and the type and size of paper that might be set for each tray.

## Supplies Status page

The Supplies Status page lists the remaining life of HP print cartridges and HP imaging drums. It also lists the estimated pages remaining, number of pages printed, and other supplies information. You can print a Supplies Status page from the printer or the embedded Web server. To print from the printer, press **(Go)** and **(CANCEL JOB)** simultaneously. (The Configuration page also prints. If you have an HP Jetdirect print server card installed, the HP Jetdirect page listing the HP Jetdirect information prints as well.)

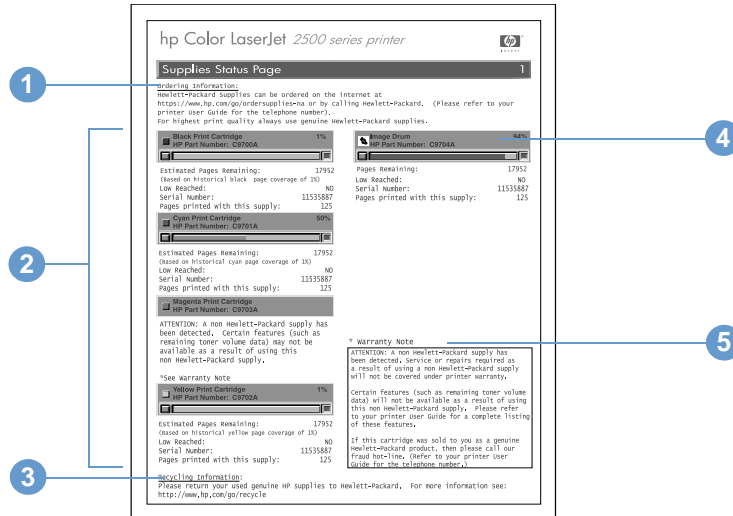

- 1 Ordering Information.** This section contains basic information about how to order new HP supplies.
- 2 Print-cartridge area.** This area contains a section for each of the print cartridges and provides information about HP print cartridges. This information includes the part number for each print cartridge, whether each print cartridge is low, and the life remaining for each print cartridge expressed as a percentage, as a graphic, and as the estimated number of pages remaining. This information is only provided for HP supplies. If a non-HP supply is installed, you see an alert message instead.
- 3 Recycling Information.** This section contains the website you can visit for information about recycling.
- 4 Imaging-drum area.** This area contains the same information for the imaging drum that the print-cartridge area provides for the print cartridges.
- 5 Warranty Note.** This section contains information about how the printer warranty is affected when you use non-HP supplies. It also requests that you call the HP fraud hotline if a supply that is being detected as a non-HP supply was sold to you as a genuine HP supply. (See [“HP fraud hotline”](#) on page 103.)

# HP Color LaserJet 2500 Toolbox

HP Color LaserJet 2500 Toolbox is only supported for Windows 98 and later. You must have performed a complete software installation to use the HP Color LaserJet 2500 Toolbox.

You can view the HP Color LaserJet 2500 Toolbox when the printer is directly connected to your computer or connected to the network. The HP Color LaserJet 2500 Toolbox is a Web page that opens in a Web browser and provides access to the embedded Web server, printer documentation, and printer management and troubleshooting tools.

To use the HP Color LaserJet 2500 Toolbox, you must have Microsoft Internet Explorer 4 or later or Netscape Navigator 4 or later. All pages can be printed from the browser.

You do not have to have Internet access to open and use the HP Color LaserJet 2500 Toolbox. However, if you click a link in the **Other Links** area, you must have Internet access in order to go to the site associated with the link.

## To view HP Color LaserJet 2500 Toolbox

- 1 Open the HP Color LaserJet 2500 Toolbox in one of these ways:
  - On the desktop, double-click the HP Color LaserJet 2500 Toolbox icon.
  - On the **Start** menu, point to **Programs**, point to **HP Color LaserJet 2500**, and choose the **HP Color LaserJet 2500 Toolbox**.

---

### Note

Once you open the URL, you can bookmark it so that you can return to it quickly in the future.

- 2 The HP Color LaserJet 2500 Toolbox opens in a Web browser. The HP Color LaserJet 2500 Toolbox software contains these tabs: the **Device** tab, the **Documentation** tab, and the **Troubleshooting** tab. It also contains an area with links to the HP website. See the following sections for more information about each tab or area.

### Device tab

The two links on this page, Information and Settings, open the page of the same name from the embedded Web server. To open the embedded Web server and see all of its settings and information, click the picture of the printer in the center of the page. If more than one HP Color LaserJet 2500 is connected to the network, you will be prompted to select one. See [“Using the embedded Web server” on page 60](#).

- **Information.** View printer status information. This information comes from the embedded Web server.
- **Settings.** View and change printer settings. This information comes from the embedded Web server.

### Documentation tab

This section of the navigation bar contains links to these information sources:

- **Install Notes.** Contains late-breaking information about the printer. In English only.
- **Read Me!** Contains information discovered after other documentation such as the user guide was developed.
- **User Guide - PDF.** Contains the information about the printer usage, warranty, specifications, and support that you are currently reading. This PDF format can be printed by page, chapter, or the entire document, and will be formatted as a traditional book.
- **User Guide - HTML.** Contains the information about the printer usage, warranty, specifications, and support that you are currently reading. This HTML format allows you to easily search for specific topics and jump between topics. Viewable from Windows-based computers only.

## Troubleshooting tab

This section of the navigation bar contains links to the information pages of the printer. (Some of these pages are also available from other sources, such as the embedded Web server or the printer itself.) From this section, you can view the following pages:

- **Control Panel Help.** Allows you to view animations of control panel light messages, identify what the light pattern means, and view information for resolving the message.
- **Cleaning Page.** You can clean the print path using this tool. See [“Managing supplies” on page 101](#) for instructions.
- **Diagnostic Tools.** These pages can help you resolve problems with color printing tasks and calibrate the printer.
- **Demo pages.** These are additional demonstration pages you can print.

## Other links

This section contains links that connect you to the Internet. You must have Internet access in order to use any of these links. If you use a dial-up connection and did not connect when you first opened the HP Color LaserJet 2500 Toolbox, you must connect before you can visit these websites. Connecting might require that you close the HP Color LaserJet 2500 Toolbox and reopen it.

- **HP Instant Support™.** Connects you to the HP website to help you find help for issues that might arise. This service analyzes your printer error log and configuration information to provide diagnostic and support information specific to your printer.
- **Order Supplies.** Click this link to connect to the HP website and order genuine HP supplies, such as print cartridges, an imaging drum, and paper.
- **Product Support.** Connects to the support site for the HP Color LaserJet 2500 printer. Then, you can search for help with a specific problem.

## Using the embedded Web server

When the printer is directly connected to a computer, the embedded Web server is supported for Windows 98 and later. When the printer is connected to the network, the embedded Web server is supported for Windows 95, Mac OS 8.6 and later, UNIX, Linux, and OS/2.



The embedded Web server allows you to view printer and network status and to manage printing functions from your computer instead of from the printer control panel. Below are examples of what you can do using the embedded Web server:

- view printer status information
- view and print internal pages
- determine the remaining life on all supplies and order new ones
- receive notification of printer and supplies events (network only)
- set the type of paper loaded in each tray
- view and change tray configurations
- view and change the printer control panel menu configuration
- view and change network configuration (network only)

To use the embedded Web server, you must have Microsoft Internet Explorer 4 or later or Netscape Navigator 4 or later. The embedded Web server works when the printer is directly connected to a computer or connected to an IP-based network. The embedded Web server does not support IPX- or AppleTalk-based printer connections.

You do not have to have Internet access to open and use the embedded Web server. However, if you click a link in the **Other Links** area, you must have Internet access in order to go to the site associated with the link.

### To open the embedded Web server

- 1 Open the embedded Web server using one of these methods:
  - From the HP Color LaserJet 2500 Toolbox, click the picture of the printer on the Device tab (Windows 98 and later only).
  - In a supported Web browser, type the IP address for the printer (networked printer only). To find the IP address, print a Configuration page at the printer by pressing  (Go) and  (CANCEL JOB) simultaneously.

---

#### Note

Once you open the URL, you can bookmark it so that you can return to it quickly in the future.

- 2 The embedded Web server has three tabs that contain settings and information about the printer: the **Information** tab, the **Settings** tab, and the **Networking** tab. Click the tab that you want to view.
- 3 See the following sections for more information about each tab.

## Information tab

The Information pages group consists of the following pages.

- **Device Status.** This page displays the printer status and shows the life remaining of HP supplies, with 0 percent representing that a supply is empty. The page also shows the type and size of print media set for each tray. To change the default settings, click **Change Settings**.
- **Configuration page.** This page shows the information found on the printer Configuration page.
- **Supplies Status.** This page shows the life remaining of HP supplies, with 0 percent representing that a supply is empty. This page also provides supplies part numbers. To order new supplies, click **Order Supplies** in the **Other Links** area on the left side of the window. To visit any website, you must have Internet access.
- **Event log.** This page shows a list of all printer events and errors.
- **Usage page.** This page shows a summary of the number of pages the printer has printed, grouped by size and type.
- **Device Information.** This page also shows the printer network name, address, and model information. To change these entries, click **Device Information** on the **Settings** tab.

## Settings tab

This tab allows you to configure the printer from your computer. The **Settings** tab can be password protected. If this printer is networked, always consult with the printer administrator before changing settings on this tab.

The **Settings** tab contains the following pages.

- **Configure Device.** Configure all printer settings from this page. This page contains the traditional menus found on printers using a control panel display. These menus include **Information**, **Paper Handling**, **Configure Device**, and **Diagnostics**.
- **Alerts.** Network only. Set up to receive e-mail alerts for various printer events.
- **Email.** Network only. Used in conjunction with the Alerts page to set up incoming and outgoing e-mail, as well as to set e-mail alerts.
- **Security.** Set a password that must be entered to gain access to the **Settings** and **Networking** tabs. Enable and disable certain features of the EWS.
- **Other Links.** Add or customize a link to another website. This link is displayed in the **Other Links** area on all embedded Web server pages. These permanent links always appear in the **Other Links** area: **HP Instant Support™**, **Order Supplies**, and **Product Support**. For more information, see [“Other links” on page 62](#).
- **Device Information.** Name the printer and assign an asset number to it. Enter the name and e-mail address for the primary contact who will receive information about the printer.
- **Language.** Determine the language in which to display the embedded Web server information.

## Networking tab

This tab allows the network administrator to control network-related settings for the printer when it is connected to an IP-based network. This tab will not appear if the printer is directly connected to a computer, or if the printer is connected to a network using anything other than an HP JetDirect print server card.

## Other links

This section contains links that connect you to the Internet. You must have Internet access in order to use any of these links. If you use a dial-up connection and did not connect when you first opened the embedded Web server, you must connect before you can visit these websites. Connecting might require that you close the embedded Web server and reopen it.

- **HP Instant Support™.** Connects you to the HP website to help you find solutions. This service analyzes your printer error log and configuration information to provide diagnostic and support information specific to your printer.
- **Order Supplies.** Click this link to connect to the HP website and order genuine HP supplies, such as print cartridges, an imaging drum, and paper.
- **Product Support.** Connects to the support site for the HP Color LaserJet 2500 printer. Then, you can search for help regarding general topics.



# Using Printer Status and Alerts

Printer Status and Alerts is only supported for Windows 98 and later.

The Printer Status and Alerts software is available to users of both networked and directly connected printers. This software allows you to view the embedded Web server information for a particular printer. It also generates messages on the computer regarding the status of the printer and print jobs. Depending on how the printer is connected, you can receive different messages.

- **Networked printers.** You can receive regular job status messages that appear every time a print job is sent to the printer or every time the print job finishes printing. You can also receive alert messages. These messages appear when you are printing to a particular printer if that printer experiences a problem but it can continue to print (such as a tray that is not being used is open, or a print cartridge is low) or a problem that prevents it from printing (such as paper is out, or a print cartridge is empty).
- **Directly connected printers.** You can receive alert messages that appear when the printer experiences a problem but it can continue to print or a problem that prevents it from printing. You can also receive messages just when supplies are low.

You can set alerts options for a single printer that supports Printer Status and Alerts, or you can set alert options for all printers that support Printer Status and Alerts. For networked printers, these alerts only appear for your jobs.

Note that even if you are setting alert options for all printers, not all options you select can apply to all printers. For example, if you select the option for notifying you when the print cartridges are low, then all directly connected printers that support Printer Status and Alerts will generate a message when the print cartridges are low. However, none of the networked printers will generate this message, nor will directly connected printers that do not support Printer Status and Alerts.

## To choose which status messages appear

- 1 Open Printer Status and Alerts in one of these ways:
  - Double-click the Printer Status and Alerts tray icon, which is near the clock in the Tray Manager.
  - On the Start menu, point to **Programs**, point to **Printer Status and Alerts**, and click **Printer Status and Alerts**.
- 2 Click the Options icon in the left pane.
- 3 In the **For** field, select the printer driver for this printer, or select **All Printers**.
- 4 Clear the options for the messages you do not want to appear, and select the options for the messages you do want to appear.
- 5 Under Status Check Rate, select how frequently you want the software to update the printer status information that the software uses to generate the messages. Status Check Rate might not be available if the printer administrator has restricted the rights to this function.

## To view status messages and information

On the left side of the window, select the printer for which you want to see information. Information provided includes status messages, supplies status, and printer capabilities. You can also click the Job History (clock) icon at the top of the window to view a list of previous jobs sent to the printer from your computer.



# 4 Problem solving and maintenance

## Introduction

This troubleshooting information is organized to help you resolve printing problems. Choose the general type of problem from the following list.

- There is a jam in the printer. See [“Clearing jams” on page 66](#).
- Printer lights, other than the Ready light, are on or blinking. See [“Resolving control panel messages” on page 71](#).
- The document printed, but the print quality was not what was expected. See [“Solving print-quality problems” on page 80](#).
- A message is on the computer. See [“Resolving problems that generated messages” on page 89](#).
- There is a problem, but no lights are on or blinking and there are no messages on the computer. See [“Resolving problems that did not generate messages” on page 90](#).

Additional information is available about these maintenance topics:

- [“Cleaning the printer” on page 99](#)
- [“Calibrating the printer” on page 100](#)
- [“Managing supplies” on page 101](#)

## Clearing jams

Occasionally, paper or other print media can become jammed during a print job. Some causes include:

- Input trays are loaded improperly or overfilled.
- Tray 2 or optional tray 3 is removed during a print job.
- The top cover is opened during a print job.
- Too many sheets accumulated in an output area or blocked an output area.
- Paper being used does not meet HP specifications. See [“Print media specifications” on page 123](#).
- The environment in which the paper was stored is too humid or too dry. See [“Print media specifications” on page 123](#).

### Where to look for jams

Jams can occur in these locations:

- Inside the printer. See [“To clear jams from inside the printer” on page 67](#).
- In input areas. See [“To clear jams from input areas” on page 68](#).
- In output areas. See [“To clear jams from output areas” on page 69](#).

Find and remove the jam using the instructions on the following pages. If the location of the jam is not obvious, look first inside the printer.

Loose toner might remain in the printer after a jam. This problem should resolve itself after a few sheets have printed. See [“Loose toner” on page 83](#).

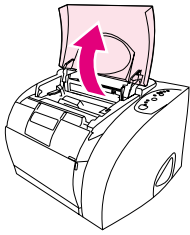
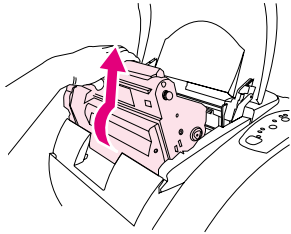
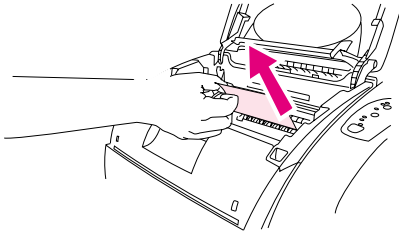
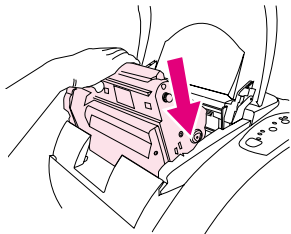
**1****2****3****4**

## To clear jams from inside the printer

### CAUTION

Jams in this area might result in loose toner on the page. If you get toner on your clothes or hands, wash them in cold water. (Hot water will set the toner into the fabric.)

- 1 Open the top cover.
- 2 Remove the *imaging drum* by pushing it away from you and lifting it out of the printer. You *cannot* reach jams by removing the print cartridges.
- 3 Complete one of these steps:
  - If the leading edge of the paper is visible, carefully pull the paper out of the printer.
  - If the paper is too difficult to remove, remove the jam as described in [“To clear jams from output areas” on page 69](#).
- 4 After the jam has been removed, replace the imaging drum and close the top cover.
- 5 Press  (Go) if the Go light is blinking. If the Attention light is still blinking, then another jam is present. See [“To clear jams from input areas” on page 68](#) and [“To clear jams from output areas” on page 69](#).

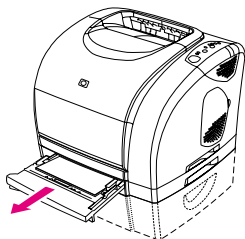
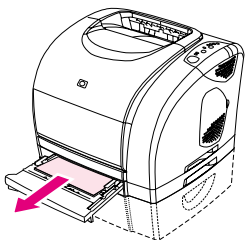
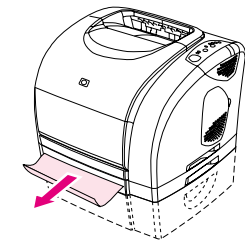
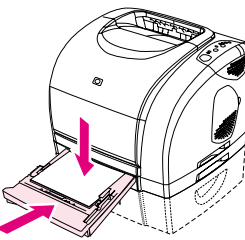
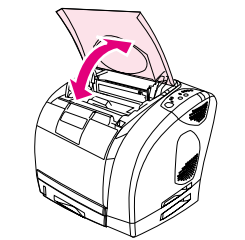
**1****2****3****4****5**

## To clear jams from input areas

- 1 Open tray 2 or optional tray 3 to expose the jam.
- 2 Complete one of these steps:
  - If the jam has already partially entered the printer, see [“To clear jams from inside the printer” on page 67](#).
  - If the jam is only in the input tray, remove the jam by pulling it out by the visible edge. Realign all of the paper in the tray and go to step 4.
- 3 If you could not remove the jam from inside the printer or by pulling it out of the tray, grasp the jam from the outside of the printer and carefully pull it free.
- 4 Push the paper down to lock the metal paper lift plate into place (tray 2 only) and slide the tray back into the printer.
- 5 Open the top cover, close it again, and then press  (Go) if the Go light is blinking. If the Attention light is still blinking, then another jam is present. See [“To clear jams from inside the printer” on page 67](#) and [“To clear jams from output areas” on page 69](#).

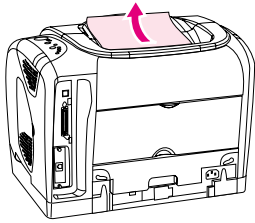
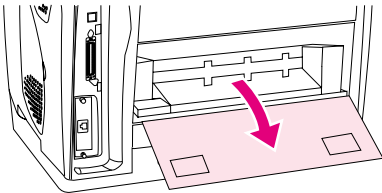
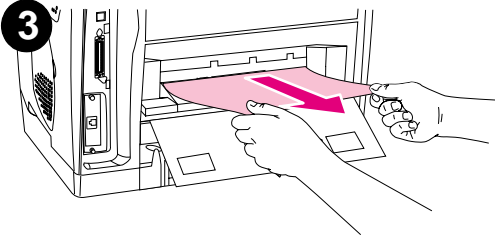
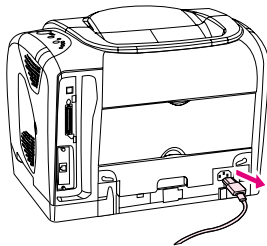
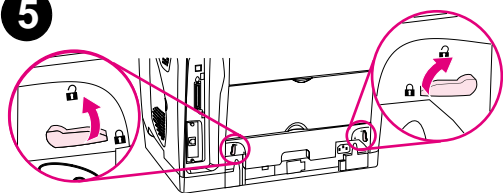
**1****2****3****4****5**

## To clear jams from output areas

### CAUTION

Jams in these areas might result in loose toner on the page. If you get toner on your clothes or hands, wash them in cold water. (Hot water will set the toner into the fabric.)

1 Complete one of these steps:

- If the paper is not almost completely visible from the top output bin, go to step 2.
- If the paper is almost completely visible, pull it carefully out of the printer and go to the last step.

2 Open the rear output door.

3 If the leading edge of the paper is visible from the rear opening, carefully pull the paper out.

4 If the jam is too far into the printer to remove, turn off the printer and disconnect the power cable.

5 Rotate the locks on the fuser to the unlocked position.

6

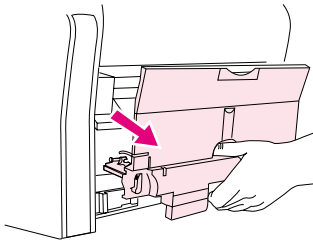

- 6 Grasp the fuser handles and pull to remove the fuser from the printer.

---

**WARNING!**

The parts on the internal surface of the fuser are very hot. To avoid burning yourself, do not touch those parts.

---

7

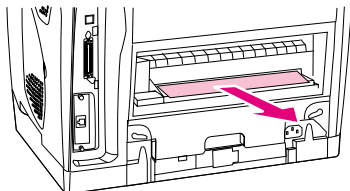

- 7 Using both hands, slowly and steadily remove any paper from inside the printer. Then, carefully reinsert the fuser and secure the locks.
- 8 Reconnect the power cable and turn on the printer.
- 9 Open the top cover, close it again, and then press  (Go) if the Go light is flashing. If the Attention light is still blinking, then there is another jam. See [“To clear jams from inside the printer”](#) on page 67 and [“To clear jams from input areas”](#) on page 68.



# Resolving control panel messages

Printer status is indicated by light patterns on the control panel. Two sets of lights are on the control panel: Supplies Status lights and Printer Status lights:

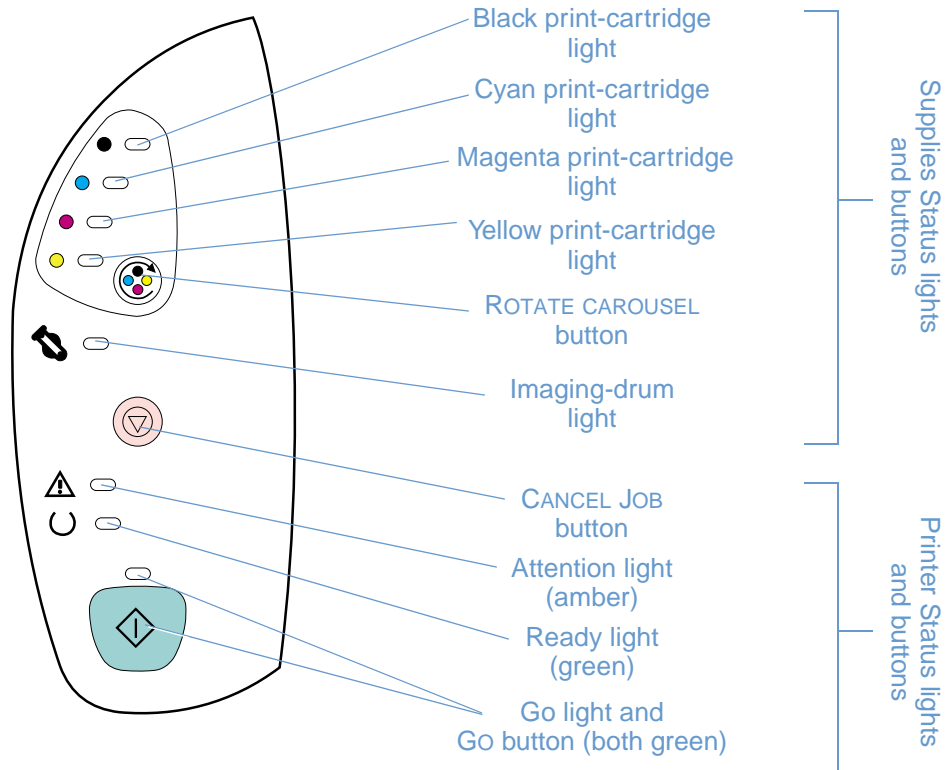

The lights can be in any one of the following states:



See the following information to interpret control panel lights. See the embedded Web server for a text message that correlates to the light pattern. Or, see the HP Color LaserJet 2500 Toolbox to view animations of the light patterns and the messages they indicate.

## Supplies Status lights

This section describes the meaning of the patterns for the lights in the Supplies Status area. Information about supplies also appears in the Printer Status and Alerts software, the embedded Web server, and the HP Color LaserJet 2500 Toolbox. (For more information, see [“Managing the printer” on page 55.](#)) To order new supplies, see the embedded Web server or see [“Accessories and ordering information” on page 24.](#)

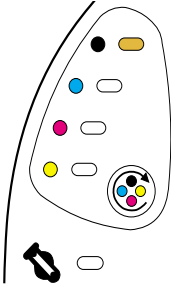
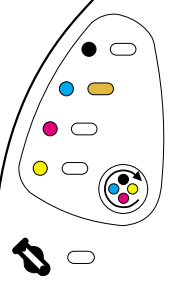
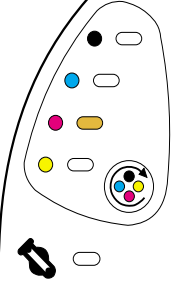
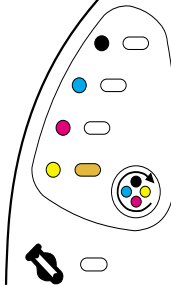
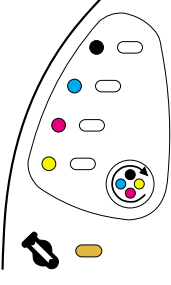
Light pattern	Recommended action
	<b>Black print cartridge low</b> The black print-cartridge light is on. The printer continues to print without any action required until the print cartridge is empty. Order a new print cartridge.
	<b>Cyan print cartridge low</b> The cyan print-cartridge light is on. The printer continues to print without any action required until the print cartridge is empty. Order a new print cartridge.
	<b>Magenta print cartridge low</b> The magenta print-cartridge light is on. The printer continues to print without any action required until the print cartridge is empty. Order a new print cartridge.
	<b>Yellow print cartridge low</b> The yellow print-cartridge light is on. The printer continues to print without any action required until the print cartridge is empty. Order a new print cartridge.
	<b>Imaging drum is low</b> The imaging-drum light is on. The printer continues to print without any action required until the imaging drum is empty. Order a new imaging drum.

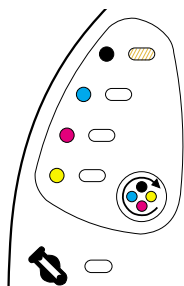

### Black print cartridge is empty or missing

The black print-cartridge light is blinking. The printer stops printing.

The print cartridge is empty or missing, or the printer cannot detect the print cartridge correctly. You must replace the print cartridge before the printer can continue printing.

Reinsert or replace the print cartridge. If the print-cartridge light is still blinking but the Attention light is not on, turn the printer off and then back on again. If the problem persists, contact HP Customer Care. See [“HP Customer Care” on page 3](#), or see the flyer that came in the printer box for contact information.

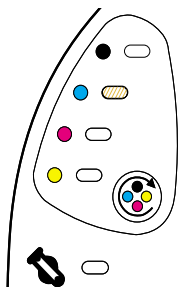

### Cyan print cartridge is empty or missing

The cyan print-cartridge light is blinking. The printer stops printing.

The print cartridge is empty or missing, or the printer cannot detect the print cartridge correctly. You must replace the print cartridge before the printer can continue printing.

Reinsert or replace the print cartridge. If the print-cartridge light is still blinking but the Attention light is not on, turn the printer off and then back on again. If the problem persists, contact HP Customer Care. See [“HP Customer Care” on page 3](#), or see the flyer that came in the printer box for contact information.

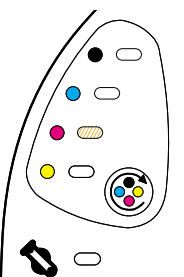

### Magenta print cartridge is empty or missing

The magenta print-cartridge light is blinking. The printer stops printing.

The print cartridge is empty or missing, or the printer cannot detect the print cartridge correctly. You must replace the print cartridge before the printer can continue printing.

Reinsert or replace the print cartridge. If the print-cartridge light is still blinking but the Attention light is not on, turn the printer off and then back on again. If the problem persists, contact HP Customer Care. See [“HP Customer Care” on page 3](#), or see the flyer that came in the printer box for contact information.

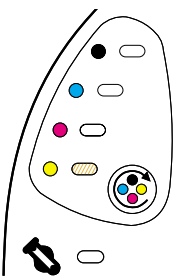

### Yellow print cartridge is empty or missing

The yellow print-cartridge light is blinking. The printer stops printing.

The print cartridge is empty or missing, or the printer cannot detect the print cartridge correctly. You must replace the print cartridge before the printer can continue printing.

Reinsert or replace the print cartridge. If the print-cartridge light is still blinking but the Attention light is not on, turn the printer off and then back on again. If the problem persists, contact HP Customer Care. See [“HP Customer Care” on page 3](#), or see the flyer that came in the printer box for contact information.

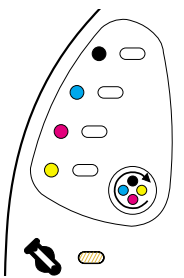

### Imaging drum is empty or missing

The imaging-drum light is blinking. The printer stops printing.

The imaging drum is empty, missing, or the printer cannot detect the imaging drum correctly. You must replace the imaging drum before the printer can continue printing.

Reinsert or replace the imaging drum. If the imaging-drum light is still blinking but the Attention light is not on, turn the printer off and then back on again. If the problem persists, contact HP Customer Care. See [“HP Customer Care” on page 3](#), or see the flyer that came in the printer box for contact information.

---

**Light pattern****Recommended action**

---

**Black print cartridge is a non-HP print cartridge**

**CAUTION:** If you continue printing once this print cartridge is empty, damage to the printer can occur. See [“Hewlett-Packard limited warranty statement” on page 106](#).

The black print-cartridge light is blinking and the Attention light is on. The printer stops printing.

If you still want to use this non-HP print cartridge, press  (**CANCEL JOB**) to continue printing. You will not receive any indication from the printer Supplies Status lights, the Supplies Status page, or any software component (HP Color LaserJet 2500 Toolbox, Printer Status and Alerts, or embedded Web server) when this print cartridge is low or empty.

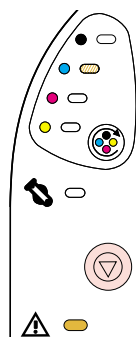
**Cyan print cartridge is a non-HP print cartridge**

**CAUTION:** If you continue printing once this print cartridge is empty, damage to the printer can occur. See [“Hewlett-Packard limited warranty statement” on page 106](#).

The cyan print-cartridge light is blinking and the Attention light is on. The printer stops printing.

If you still want to use this non-HP print cartridge, press  (**CANCEL JOB**) to continue printing. You will not receive any indication from the printer Supplies Status lights, the Supplies Status page, or any software component (HP Color LaserJet 2500 Toolbox, Printer Status and Alerts, or embedded Web server) when this print cartridge is low or empty.

**Magenta print cartridge is a non-HP print cartridge**

**CAUTION:** If you continue printing once this print cartridge is empty, damage to the printer can occur. See [“Hewlett-Packard limited warranty statement” on page 106](#).

The magenta print-cartridge light is blinking and the Attention light is on. The printer stops printing.

If you still want to use this non-HP print cartridge, press  (**CANCEL JOB**) to continue printing. You will not receive any indication from the printer Supplies Status lights, the Supplies Status page, or any software component (HP Color LaserJet 2500 Toolbox, Printer Status and Alerts, or embedded Web server) when this print cartridge is low or empty.

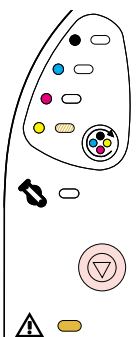
**Yellow print cartridge is a non-HP print cartridge**

**CAUTION:** If you continue printing once this print cartridge is empty, damage to the printer can occur. See [“Hewlett-Packard limited warranty statement” on page 106](#).

The yellow print-cartridge light is blinking and the Attention light is on. The printer stops printing.

If you still want to use this non-HP print cartridge, press  (**CANCEL JOB**) to continue printing. You will not receive any indication from the printer Supplies Status lights, the Supplies Status page, or any software component (HP Color LaserJet 2500 Toolbox, Printer Status and Alerts, or embedded Web server) when this print cartridge is low or empty.

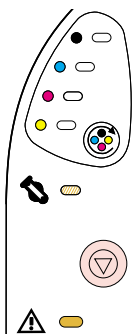
**Imaging drum is a non-HP imaging drum**

**CAUTION:** If you continue printing once this imaging drum is empty, damage to the printer can occur. See [“Hewlett-Packard limited warranty statement” on page 106](#).









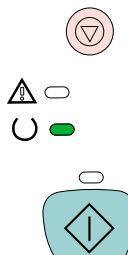

The imaging-drum light is blinking and the Attention light is on. The printer stops printing.

If you still want to use this non-HP imaging drum, press  (**CANCEL JOB**) to continue printing. You will not receive any indication from the printer Supplies Status lights, the Supplies Status page, or any software component (HP Color LaserJet 2500 Toolbox, Printer Status and Alerts, or embedded Web server) when this print cartridge is low or empty.

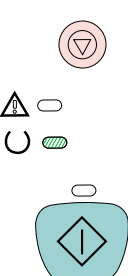
---

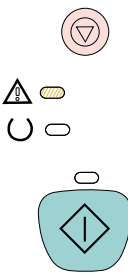
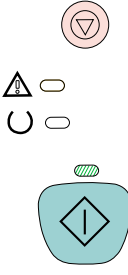
## Printer Status lights





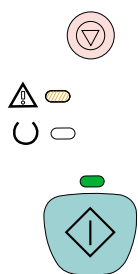



The following section describes the meaning of the light patterns in the Printer Status area. Information about the printer status also appears in the Printer Status and Alerts software and the embedded Web server. (For more information, see [“Managing the printer” on page 55.](#))

Light pattern	Error and recommended action
All control panel lights	<b>Startup</b> All control panel lights cycle one after another. Pressing buttons has no effect until the printer is in the Ready state.
	<b>Ready</b> The Ready (green) light is on and the printer is ready to print. No action is needed. Pressing  (Go) prints a Demo page. Pressing  (Go) and  (CANCEL JOB) simultaneously prints a Configuration page and a Supplies Status page, as well as an HP Jetdirect page if an HP Jetdirect print server card is installed.
	<b>Processing</b> The Ready light is blinking. The printer is receiving or processing data. Pressing  (CANCEL JOB) cancels the current job. One or two pages might print as the printer clears the print job. The printer returns to the Ready state (Ready light on) after the job has been canceled.
	<b>Attention error</b> The Attention light is blinking in these situations: <ul style="list-style-type: none"><li>• The top cover is open.</li><li>• The printer is out of paper.</li><li>• The printer has a jam.</li></ul> For the first cause, close the top cover. For the second cause, load paper. For the last cause, open and close the top cover after you resolve the problem. If the problem is not resolved, the Attention light continues to blink.
	<b>Interaction state</b> The Go light is blinking. The top cover has been opened and then closed, or you pressed  (ROTATE CAROUSEL). Pressing  (Go) returns the printer to the Ready state. If you do not press  (Go), the printer automatically returns to the Ready state after approximately 10 seconds. Pressing  (ROTATE CAROUSEL) brings another print cartridge to the top position.



### Attention with Ability to Continue

The Attention light is blinking and the Go light is on. The printer stops printing. The message appears in these situations:

- **Manual feed with pause.** Someone sent a manual feed job and the printer is waiting for the special paper. Load paper into tray 1, and if the printer does not begin printing once the pages are reloaded, press  (Go). Or, just press  (Go) to try to print from another tray.
- **Manual two-sided printing.** The printer has finished printing the first side of a manual duplex job, and the printer is waiting for someone to reload the pages so it can print the second side. If the printer does not begin printing once the pages are reloaded, press  (Go).
- **Paper out in the selected tray.** Someone is trying to print by Source (tray) and there is no paper in the selected tray. Add paper to that tray to print from it. Or, press  (Go) to try to print from another tray. The printer continues printing after it finishes running a cleaning cycle, which takes approximately 20 seconds.
- **Paper is too small.** The print image is larger than the size of paper in the tray. Load the correct size and press  (Go). The printer continues printing after it finishes running a cleaning cycle, which takes approximately 20 seconds.
- **Continuable state.** Press  (Go) for the printer to attempt to recover from the error and print whatever data it can. If successful, the printer completes the job while Ready light blinks. If unsuccessful, the printer continues to display the Attention with Ability to Continue state. Perform one of these steps:
  - Press and hold  (Go) and  (CANCEL JOB) simultaneously to display a secondary light pattern. (See “Secondary light patterns for Printer Status lights” on page 77.)
  - Press  (CANCEL JOB) to cancel the print job. If the problem has been resolved, the printer returns to the Ready state (Ready light on).

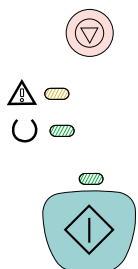

### Accessory error

The Attention light, Ready light, and Go light are blinking. The printer stops printing. An error has occurred with either the EIO port or a DIMM slot. Pressing any button has no effect.

Press and hold  (Go) and  (CANCEL JOB) simultaneously to display a secondary light pattern. (See “Secondary light patterns for Printer Status lights” on page 77.)

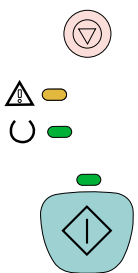

### Service error



The Attention light, Ready light, and Go light are on. The printer stops printing. Pressing any button has no effect. Perform these steps.

- Turn the printer off and then on again. If the problem persists, leave the printer off for 15 minutes to reset the printer.
- If the printer is connected to a power strip or surge protector, disconnect it and connect the power cable directly to a working wall outlet.
- If the problem continues, contact HP Customer Care. See “HP Customer Care” on page 3 or the support flyer that came in the printer box.

## Secondary light patterns for Printer Status lights

This section describes the secondary light patterns that you can display when you experience a Attention with Ability to Continue state or an Accessory error. Each of these errors has its own set of secondary light patterns, so a section is included here for each set.

Secondary light patterns provide more information about the more specific type of error that occurred. To understand the secondary light pattern, do one of these steps:

- Press and hold  (Go) and  (CANCEL JOB) simultaneously. When the secondary light pattern appears, use the appropriate section here to identify the associated error. When you release the buttons, the light pattern for the original error appears again.
- View the embedded Web server, which provides a text message that corresponds to the error and its secondary light pattern.

### Secondary light patterns for Attention with Ability to Continue state

This section provides the meaning for the secondary light patterns that you can display while you are experiencing an Attention with Ability to Continue state (Attention light is blinking and Go light is on).

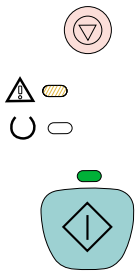

#### Light pattern

#### Error and recommended action

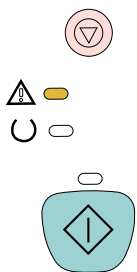

#### 20 Insufficient Memory error

Attention light is on. The printer memory is full.

Press  (Go) to resume printing. If you lose some data, try to free some printer memory by removing any unnecessary fonts, macros, or any data currently in printer memory. If you continue to lose data, you might need to add more printer memory. For a temporary solution, simplify the image by changing to another image type, such as raster.

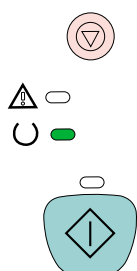

#### 41.3 Unexpected Size error or 41.x Printer error

The Ready light is on.

- Load the correct size of paper. If the correct size is loaded, press  (Go).
- If printing does not resume, open the top cover, remove the imaging drum, and check for a jam inside the printer.

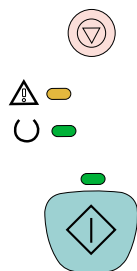

#### 40 Bad Transmission error

The Attention light, Ready light, and Go light are on. Press  (Go) to try to print a portion of the job.

- If the printer is connected to the network, make sure the cable is securely connected between the HP Jetdirect print server card and the network port.
- If the printer is directly connected to a computer, the cable between the printer and computer has a bad connection or the cable is of poor quality. Disconnect the cable and reconnect it. Make sure you are using a high-quality USB or IEEE-1284 compliant, size-B parallel cable. See [“Accessories and ordering information” on page 24](#)

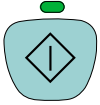

## 22 Buffer Overflow error

The Ready light and Go light are on. Press (Go) to try to print a portion of the job.

- The connection between the printer and the computer is loose. Check the connection to ensure that it is secure.
- The cable is malfunctioning. Try using a different, high-quality USB or IEEE-1284 compliant, size-B parallel cable. See [“Accessories and ordering information” on page 24](#)
- Contact HP Customer Care. See [“HP Customer Care” on page 3](#), or see the flyer that came in the printer box for contact information.

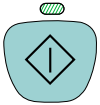

## Chosen Personality Not Available error

The Ready light and Go light are blinking. The current job was canceled because the printer language (personality) is not supported.

- Press (Go) to clear the message.
- If you printed the job using one of the PCL drivers, try printing using the PS driver, or vice versa.
- Turn off the printer and remove or replace the language font DIMM. **Caution:** You must turn off the printer before inserting or removing DIMMs.
- Contact HP Customer Care. See [“HP Customer Care” on page 3](#), or see the flyer that came in the printer box for contact information.

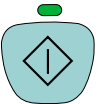

## Data Received error

The Go light is on.

- The printer received data and is waiting for a form feed. Press (Go) to print the last page. The printer receiving another job can also cause the page to print.

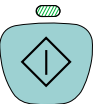

## General Continuable error

The Attention light, Ready light, and Go light are blinking.

- Press (Go) to try to continue printing.
- If the error persists, contact HP Customer Care. See [“HP Customer Care” on page 3](#), or see the flyer that came in the printer box for contact information.

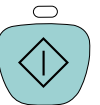

## 68.x Permanent Storage error

The Attention light is blinking. The nonvolatile memory (NVRAM) is temporarily full.

Press (Go) to clear the message. Check the printer settings to ensure they are correct. If the problem persists, contact HP Customer Care. See [“HP Customer Care” on page 3](#), or see the flyer that came in the printer box for contact information.



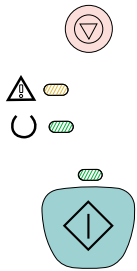

## Secondary light patterns for Accessory errors

This section describes the secondary light patterns that you can display when you experience an Accessory error (Attention light, Ready light, and Go light are blinking).

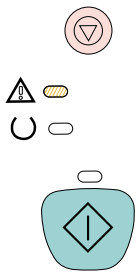

### 8x.yyyy EIO error

The Attention light is blinking. There is a problem with the print server card.

**Caution:** You must turn off the printer before inserting or removing the print server card to avoid damaging it.

- Remove the print server card and reinstall it to ensure that it was correctly installed.
- Ensure that you are using a supported print server card. See [“Accessories and ordering information” on page 24](#).
- To continue printing, remove the print server card from the EIO port and connect a parallel or USB cable. You must change the port, or reinstall the software.
- If the print server card still is not working, contact HP Customer Care. See [“HP Customer Care” on page 3](#) or the support flyer that came in the printer box.

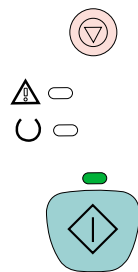

### 53.x1.zz Printer (DIMM Slot 1) error

The Go light is on. There is a problem with the DIMM in this DIMM slot.

**Caution:** You must turn off the printer before inserting or removing DIMMs to avoid damaging them.

- Remove the DIMM and reinstall it to ensure that it is correctly installed.
- Ensure that you are using a supported DIMM. See [“Accessories and ordering information” on page 24](#).
- Move the DIMM to a different DIMM slot. If the DIMM works in a different slot, then DIMM slot 1 is malfunctioning. See [“HP Customer Care” on page 3](#) or the support flyer that came in the printer box.
- To continue printing, remove the DIMM from DIMM slot 1.

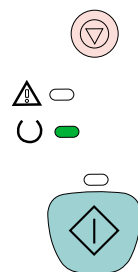

### 53.x2.zz Printer (DIMM Slot 2) error

The Ready light is on. There is a problem with the DIMM in this DIMM slot.

**Caution:** You must turn off the printer before inserting or removing DIMMs to avoid damaging them.

- Remove the DIMM and reinstall it to ensure that it is correctly installed.
- Ensure that you are using a supported DIMM. See [“Accessories and ordering information” on page 24](#).
- Move the DIMM to a different DIMM slot. If the DIMM works in a different slot, then DIMM slot 2 is malfunctioning. See [“HP Customer Care” on page 3](#) or the support flyer that came in the printer box.
- To continue printing, remove the DIMM from DIMM slot 2.

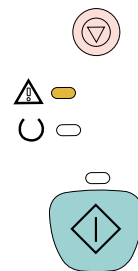

### 53.x3.zz Printer (DIMM Slot 3) error

The Attention light is on. There is a problem with the DIMM in this DIMM slot.

**Caution:** You must turn off the printer before inserting or removing DIMMs to avoid damaging them.



- Remove the DIMM and reinstall it to ensure that it is correctly installed.
- Ensure that you are using a supported DIMM. See [“Accessories and ordering information” on page 24](#).
- Move the DIMM to a different DIMM slot. If the DIMM works in a different slot, then DIMM slot 3 is malfunctioning. See [“HP Customer Care” on page 3](#) or the support flyer that came in the printer box.
- To continue printing, remove the DIMM from DIMM slot 3.

## Solving print-quality problems

If your document is printing but the quality is not what you expected, start by using the print-quality checklist

### Print-quality checklist

General print-quality problems can be solved by following the checklist below.

- 1 Check the printer driver to make sure you are using the best available print-quality option, or return to the default settings. See [“Changing print quality” on page 41](#).
- 2 Check that the paper or print media you are using meets specifications. See [“Print media specifications” on page 123](#). Generally, smoother paper provides better results although coated, photo, and glossy papers are not supported.
- 3 If you are using a special print media such as labels, grayscale transparencies, or letterhead, ensure that you have printed by Type. See [“Printing a job” on page 34](#).
- 4 Print a Configuration page and Supplies Status page at the printer by pressing  (Go) and  (CANCEL JOB) simultaneously.
  - Check the Supplies Status page to see if any supplies are low or empty. No information is provided for non-HP print cartridges.
  - If the pages do not print correctly, the problem is with the hardware. Contact HP Customer Care. See [“HP Customer Care” on page 3](#) or the flyer that shipped in the printer box.
- 5 Print a Demo page from the HP Color LaserJet 2500 Toolbox. If the page prints, the problem is with the printer driver. Try printing from one of the other printer drivers. For example, if you are using the PCL 6 printer driver, print from the PCL 5c or PS printer driver.
- 6 Try printing from a different program. If the page prints correctly, the problem is with the program from which you were printing.
- 7 Restart the computer and the printer and try printing again. If the problem is not resolved, choose one of these options:
  - If the problem is affecting all printed pages, see [“Solving issues with all printed documents” on page 81](#).
  - If the problem is affecting only pages printed in color, see [“Solving issues with color documents” on page 87](#).

## Solving issues with all printed documents

The examples below depict letter-size paper that has passed through the printer short-edge first. These examples illustrate problems that would affect all pages you print, whether you print in color or in black only. The topics that follow list the typical cause and solution for each of these examples.

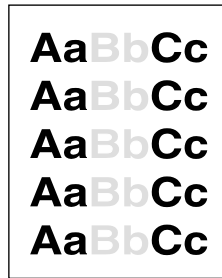

Light print or fade

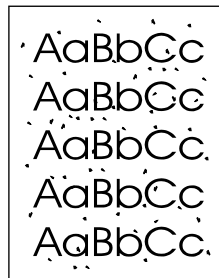

Toner specks

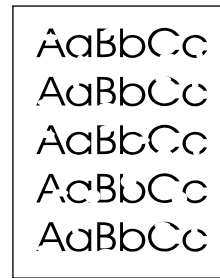

Dropouts

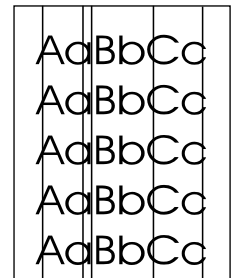

Vertical lines



Gray background

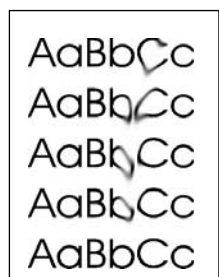

Toner smear

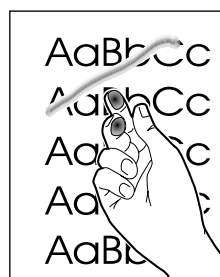

Loose toner

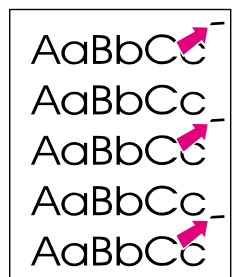

Repetitive defects on the front

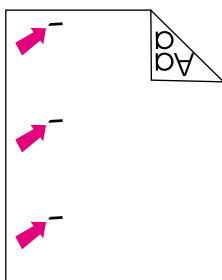

Repetitive defects on the back

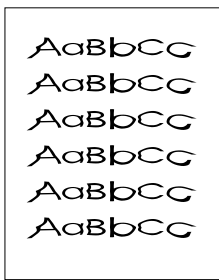

Misformed characters

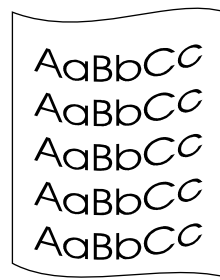

Curl or wave

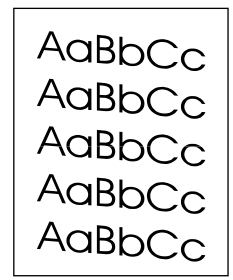

Page skew

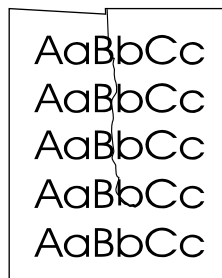

Wrinkles or creases

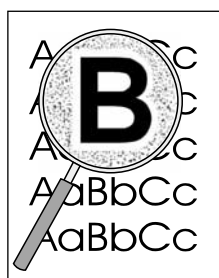

Toner scatter outline

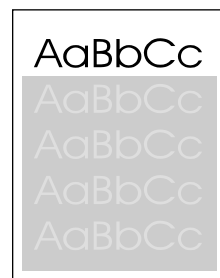

Random image repetition (light)



Random image repetition (dark)

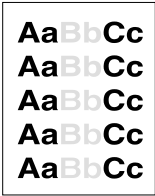

## Light print or fade

A vertical streak or an incorrect or faded color area appears on the page.

- The paper might not meet HP's paper specifications (for example, the paper is too moist or too rough). See ["Print media specifications" on page 123](#).
- One or more print cartridges are low. If you are using non-HP print cartridges, no messages appear on the printer control panel or in the embedded Web server.
- The imaging drum might be low or empty. Print the Supplies Status page to check remaining life. Replace the imaging drum if it is low or empty.
- If none of the print cartridges or the imaging drum is low or empty, remove the print cartridges one at a time and inspect the toner roller in each to see if the roller is damaged. If so, replace the print cartridge.
- If the problem is not resolved, see ["If the problem is not resolved" on page 86](#).



## Toner specks

- The paper might not meet specifications. For example, the paper is too moist or too rough. See ["Print media specifications" on page 123](#).
- The paper path might need cleaning. See ["Cleaning the printer" on page 99](#).
- If the problem is not resolved, see ["If the problem is not resolved" on page 86](#).

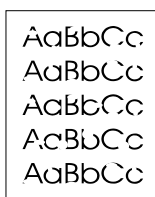

## Dropouts

Faded areas, generally rounded, occur randomly on the page.

- A single sheet of paper might be defective. Try reprinting the job.
- The moisture content of the paper is uneven or the paper has moist spots on its surface. Try different paper, such as high-quality paper intended for laser printers. See ["Print media specifications" on page 123](#).
- The paper lot is flawed. The manufacturing processes can cause some areas to reject toner. Try a different brand of paper, such as high-quality paper intended for laser printers. See ["Print media specifications" on page 123](#).
- The imaging drum might be defective. See ["Repetitive defects on the front" on page 84](#).
- If these steps do not correct the problem, contact HP Customer Care. See ["HP Customer Care" on page 3](#) or the support flyer that came in the printer box.
- If the problem is not resolved, see ["If the problem is not resolved" on page 86](#).

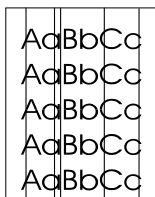

## Vertical lines

Vertical streaks or bands appear on the page.

- One or more print cartridges are low or defective. Print the Supplies Status page to check remaining life. If you are using non-HP print cartridges, no messages appear on the printer control panel or in the embedded Web server.
- Clean the printer using a cleaning page. See ["Cleaning the printer" on page 99](#).
- Use the tools on the **Troubleshooting** tab of the HP Color LaserJet Toolbox to correct the problem.
- If the problem is not resolved, see ["If the problem is not resolved" on page 86](#).



### Gray background

The amount of background toner shading becomes unacceptable.

- Perform a calibration. See [“Calibrating the printer” on page 100](#).
- Use a different paper with a lighter basis weight. See [“Print media specifications” on page 123](#).
- Check the printer environment. Very dry (low humidity) conditions can increase the amount of background shading.
- One or more print cartridges are low. If you are using non-HP print cartridges, no messages appear on the printer control panel or in the embedded Web server.
- The imaging drum might be low or empty. Print the Supplies Status page to check remaining life. Replace the imaging drum if it is low or empty.
- If the problem is not resolved, see [“If the problem is not resolved” on page 86](#).

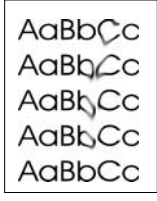

### Toner smear

Toner smears appear on the leading edge of the paper.

- Check the paper type and quality. Use a different paper, such as high-quality paper intended for laser printers. See [“Print media specifications” on page 123](#).
- If toner smears appear on the leading edge of the paper, the paper guides are dirty, or there is debris in the print path. See [“Cleaning the printer” on page 99](#).
- The imaging drum might be low or empty. Check the status of the imaging drum using the printer control panel or the embedded Web server and replace the imaging drum if it is low or empty.
- If the problem is not resolved, see [“If the problem is not resolved” on page 86](#).

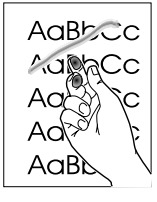

### Loose toner

Toner smears easily when touched.

- In the printer driver, select the **Paper** tab and set **Type is** to match the type of paper you are printing. Print speed might be slower if you are using heavy paper. For UNIX, Linux, and OS/2, this feature is available in the embedded Web server if the printer is connected to a network.
- Check the paper type and quality. Use a different paper, such as high-quality paper intended for laser printers. See [“Print media specifications” on page 123](#).
- Clean the inside of the printer. See [“Cleaning the printer” on page 99](#).
- The fuser might be damaged. Contact HP Customer Care. See [“HP Customer Care” on page 3](#) or the support flyer that came in the printer box.
- If the problem is not resolved, see [“If the problem is not resolved” on page 86](#).

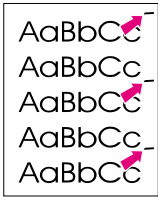

## Repetitive defects on the front

Marks repeatedly appear on the printed side of the page at even intervals.

- In the printer driver, select the **Paper** tab and set **Type is** to match the type of paper on which you are printing. Print speed might be slower if you are using heavy paper. For UNIX, Linux, and OS/2, this feature is available in the embedded Web server if the printer is connected to a network.
- Clean the printer. See [“Cleaning the printer” on page 99](#).
- Use the tools on the **Troubleshooting** tab of the HP Color LaserJet Toolbox to correct the problem.
- The imaging drum might be defective. Replace the imaging drum.
- The fuser might be damaged. Contact HP Customer Care. See [“HP Customer Care” on page 3](#) or the support flyer that came in the printer box.
- If the problem is not resolved, see [“If the problem is not resolved” on page 86](#).

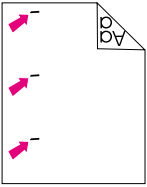

## Repetitive defects on the back

Marks repeatedly appear on the unprinted side of the page at even intervals.

- Internal parts might have toner on them. The problem will likely correct itself after a few more pages.
- Clean the printer. See [“Cleaning the printer” on page 99](#).
- The fuser might be damaged. Contact HP Customer Care. See [“HP Customer Care” on page 3](#) or the support flyer that came in the printer box.
- If the problem is not resolved, see [“If the problem is not resolved” on page 86](#).

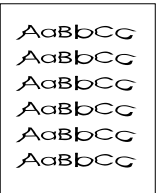

## Misformed characters

- If characters are improperly formed so that they produce hollow images, the paper might be too slick of a paper, such as a photo, glossy, or coated paper. Use a different paper, such as high-quality paper intended for laser printers. See [“Print media specifications” on page 123](#).
- If characters are improperly formed so that they produce a wavy effect, the laser scanner might need service. Verify that the problem also occurs on the Configuration page. If so, contact HP Customer Care. See [“HP Customer Care” on page 3](#) or the support flyer that came in the printer box.
- If the problem is not resolved, see [“If the problem is not resolved” on page 86](#).

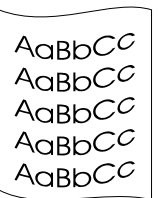

## Curl or wave

- Turn over the stack of paper in the tray. Also try rotating the paper 180 degrees in the input tray.
- Set the correct Type in the printer driver. Heavier paper might take longer to print.
- Open the rear output door to print to the straight-through paper path.
- Check the paper type and quality. Both high temperature and humidity will cause paper curl. Use a different paper, such as high-quality paper intended for laser printers. See [“Print media specifications” on page 123](#).
- If the problem is not resolved, see [“If the problem is not resolved” on page 86](#).

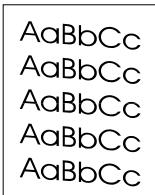

### Page skew

- Make sure the paper or other print media is loaded correctly and that the guides are not too tight or too loose against the stack. See [“Loading trays” on page 31](#).
- Check the paper type and quality. Use a different paper, such as high-quality paper intended for laser printers. See [“Print media specifications” on page 123](#).
- If the problem is not resolved, see [“If the problem is not resolved” on page 86](#).

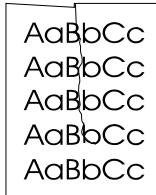

### Wrinkles or creases

- Make sure that paper is loaded properly.
- Turn over the stack of paper in the input tray, or try rotating the paper 180 degrees in the input tray.
- Open the rear output door to print to the straight-through paper path.
- Check the paper type and quality. Use a different paper, such as high-quality paper intended for laser printers. See [“Print media specifications” on page 123](#).
- If the problem is not resolved, see [“If the problem is not resolved” on page 86](#).

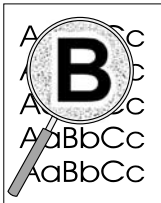

### Toner scatter outline

- Turn over the stack of paper in the tray.
- Perform a calibration. See [“Calibrating the printer” on page 100](#).
- Small amounts of toner scatter are normal for laser printing.
- If large amounts of toner have scattered around the characters, the paper might have high resistivity. Use a different paper, such as high-quality paper intended for laser printers. See [“Print media specifications” on page 123](#).
- Change the print mode in the embedded Web server to High Resistivity.
- If the problem is not resolved, see [“If the problem is not resolved” on page 86](#).



### Random image repetition

If an image that appears at the top of the page (in solid black) repeats farther down the page (in gray field), the toner might not have been completely erased from the last job. The repeated image might be lighter or darker than the field in which it appears.

- From your program, change the tone (darkness) of the field that the repeated image appears in.
- From your program, rotate the whole page 180 degrees to print the lighter image first.
- Change the order in which the images are printed. For example, have the lighter image at the top of the page, and the darker image further down the page.
- If the defect occurs later in a print job, turn the printer off for 10 minutes, and then turn the printer on to restart the print job.
- If the problem is not resolved, see [“If the problem is not resolved” on page 86](#).



## If the problem is not resolved

If the problem is not resolved, try these steps:

- 1 Perform a cleaning and calibration. See [“Cleaning the printer” on page 99](#).
- 2 Print the Configuration page and Supplies Status page again.
  - If the pages print correctly, then the problem is with the program, computer, or printer driver. Go to the next step.
  - If the pages do not print correctly, then the problem is with the printer itself. The problem might be the fuser. Contact HP Customer Care. See [“HP Customer Care” on page 3](#) or the support flyer that came in the printer box.
- 3 Change the Type setting in the printer driver, or change the print mode in the embedded Web server. If this step does not help, go to the next step.
- 4 If the problem still persists, check the paper type and quality. (See [“Print media specifications” on page 123](#).) Use a different paper, such as high-quality paper intended for laser printers. Coated, photo, and glossy papers are not supported.
- 5 Print to a different printer.
  - If the page prints correctly, then the problem is with the printer driver for the HP Color LaserJet 2500 printer. Uninstall the printer driver and reinstall it.
  - If the page does not print correctly, the problem is with the program or the computer. See the documentation for the program or the computer.



## Solving issues with color documents

This section describes issues that can occur when you print in color. *Whenever you are experiencing color-related issues, calibrate the printer before trying any other steps.* See “Calibrating the printer” on page 100.

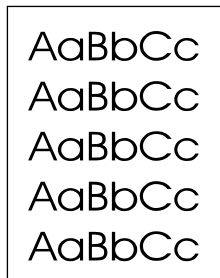

Only black prints

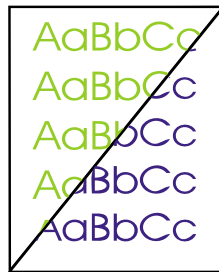

Missing or incorrect color

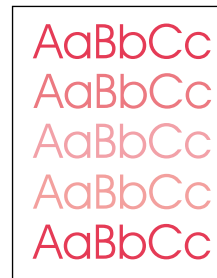

Color prints inconsistently



Colors do not match



Color pages have inconsistent finish



### Only black prints

Only black is printing when the document should be printing in color.

- Color mode is not selected in your program or printer driver. Select color mode instead of grayscale mode.
- If you are printing on transparencies, all transparencies print in grayscale.
- The correct printer driver is not selected in the program. Select the correct printer driver.
- The printer is not properly configured. Verify the printer configuration by printing a Configuration page. If no color appears on the Configuration page, contact HP Customer Care.



## Missing or incorrect color

- You have changed the color settings manually. Return the color setting to Automatic. See [“Changing color settings” on page 39](#).
- Your print media does not meet the specifications for this printer. Use a different paper, such as a high-quality paper intended for laser printers. See [“Print media specifications” on page 123](#).
- You are operating the printer in excessively humid conditions. Verify that the printer environment is within humidity specifications.
- A print cartridge might be low. Check the printer control panel, print a Supplies Status page, or view the embedded Web server to see. (If you are using a non-HP cartridge, none of these sources will provide information about a low or empty print cartridge.) If so, replace the print cartridge.
- Perform a calibration. See [“Calibrating the printer” on page 100](#).



## Color prints inconsistently

A color is printing inconsistently after you load a new print cartridge.

- Another print cartridge might be low. Check the supplies status lights or embedded Web server to see if a print cartridge is low and replace it if necessary. If you are using a non-HP print cartridge, it might be low or empty but you will receive no indication.
- Print cartridges might be improperly installed. Remove the print cartridge for the color that is printing inconsistently and reinstall it.



## Colors do not match

The colors on the printed page do not match the colors as they appear on the screen.

- The colors on your computer monitor differ from the printer output. Try selecting Screen Match in the **Color** tab of the printer driver.
- Print the Configuration and Supplies Status pages to ensure that they print correctly. If not, the problem is with the printer.
- Try printing from a different program or one of the other printer drivers. For example, if you are using the PCL 6 printer driver, try the PCL 5c or PS printer driver.
- Extremely light colors or extremely dark colors on screen are not printing. Your program might interpret extremely light colors as white or extremely dark colors as black. If so, avoid using extremely light or extremely dark colors.
- Other factors, such as the light or paper quality, are affecting the output. Use a different paper, such as a high-quality paper intended for laser printers. See [“Print media specifications” on page 123](#) and [“Using color” on page 50](#).
- Perform a calibration. See [“Calibrating the printer” on page 100](#).



## Color pages have inconsistent finish

- Use a smooth paper or print media, such as a high-quality paper made for laser printers. Generally, the smoother the paper, the better the results. Coated, photo, and glossy papers are not supported. See [“Print media specifications” on page 123](#).

# Resolving problems that generated messages

This section helps resolve problems that generated messages on the computer.

## Messages for both Windows and Macintosh

This section lists some common errors that only provide a simple message but no information for resolving the error. Errors that you see in Printer Status and Alerts, the HP Color LaserJet 2500 Toolbox, or the embedded Web server provide their own instructions for resolving the error. For other errors generated by your operating system, see the documentation for the operating system or computer.

Symptom	Possible Cause	Solution
Limit Check Error	The print job is too complex.	<ul style="list-style-type: none"><li>You might need to reduce the complexity of the page or install more memory.</li><li>Use one of the other printer drivers.</li><li>Send the print job in smaller pieces or in fewer numbers of pages.</li></ul>

## Messages for Windows only



Message	Solution
"Error Writing to LPTx" in Windows 95, 98, or Me.	<ul style="list-style-type: none"><li>Make sure that there is paper in the tray.</li><li>Make sure the cables are connected correctly, the printer is on, and the Ready light is on.</li><li>Ensure that the printer is not connected using both a USB and a parallel cable.</li><li>Print a Demo page from the HP Color LaserJet 2500 Toolbox to ensure that the computer can communicate with the printer.</li><li>On the <b>Start</b> menu, point to <b>Settings</b> and click <b>Printers</b>. Right-click the HP Color LaserJet 2500 driver and select <b>Properties</b>. Click <b>Details</b> and then click <b>Port Settings</b>. Clear the <b>Check Port State before Printing</b> check box and click <b>OK</b>. Click <b>Spool Settings</b>, select <b>Print Directly to Printer</b>, and click <b>OK</b>.</li><li>Try printing again.</li></ul>
"General Protection Fault" "Exception OE" "Spool32" "Illegal Operation"	<ul style="list-style-type: none"><li>Restart the computer and try again.</li><li>Clear the contents of the computer Temp folder, which is generally located in C:\Windows (95, 98, and Me) or C:\Winnt (NT 4.0, 2000, XP).</li></ul>
Other Windows messages	See Microsoft Windows 95, 98, 2000, NT 4.0, Me, or XP documentation that came with the operating system or computer for information.

# Resolving problems that did not generate messages

Begin by using the troubleshooting checklist.

## Troubleshooting checklist

If the printer is not responding properly, complete the steps in the following checklist, in order. If the printer does not pass a step, follow the corresponding troubleshooting suggestions. If a step resolves the problem, you can stop without performing the rest of the steps on the checklist.

- 1** Make sure the printer Ready light is on. If no lights are on, complete these steps:
  - a** Check the power cable connections.
  - b** Check that the power switch is on.
  - c** Check the power source by plugging the printer directly into the wall or into a different outlet.
  - d** If none of these measures restores power, contact HP Customer Care. (See [“HP Customer Care” on page 3](#) or the support flyer that came in the printer box.)
- 2** Check the cabling.
  - a** Check the cable connection between the printer and the computer or network port. Make sure the connection is secure.
  - b** Make sure that the cable itself is not faulty by using a different cable, if possible.
  - c** Make sure you do not have both a USB and a parallel cable installed. If you do, the USB automatically disables itself.
  - d** Check the network connection. See [“Checking the network” on page 91](#).
- 3** Ensure that the print media you are using meets specifications. See [“Print media specifications” on page 123](#).
- 4** Press  (GO) and  (CANCEL JOB) simultaneously to print a Configuration page and a Supplies Status page. An HP Jetdirect page also prints, if a print server card is installed.
  - a** If the pages do not print, check that there is paper in at least one tray.
  - b** If the page jams in the printer, go to [“Clearing jams” on page 66](#).
- 5** If the Configuration and Supplies Status pages print, check the following items.
  - a** If the pages print correctly, then the printer hardware is working. The problem is with the computer you are using, with the printer driver, or with the program.
  - b** If the pages do not print correctly, calibrate the printer. See [“Calibrating the printer” on page 100](#). Print the pages again. If the pages still do not print correctly, the problem is with the printer hardware. Contact HP Customer Care. (See [“HP Customer Care” on page 3](#) or the support flyer that came in the printer box.)
- 6** At the computer, check the print queue or print spooler (Print Monitor or Print Center Queue for Mac OSs) to see if the printer is paused or set to print offline.
- 7** Verify that you have installed the HP Color LaserJet 2500 series printer driver. Check the program to make sure that you are using an HP Color LaserJet 2500 series printer driver.

- 8 Print a page from the HP Color LaserJet 2500 Toolbox (Windows 98 and higher only).
  - a If it prints, then the problem is with the printer driver. Try using one of the other printer drivers. Or, uninstall the printer driver (see [“Uninstalling the printing software” on page 22](#)) and reinstall it (see the getting started guide).
  - b If the page does not print, then the problem is with the computer or the program.
- 9 Print a short document from a different program that has worked in the past. If this solution works, then the problem is with the program you are using. If this solution does not work (the document does not print) complete these steps:
  - a Try printing the job from another computer that has the printer software installed.
  - b If you connected the printer to the network, connect the printer directly to a computer with a parallel or USB cable. Redirect the printer to the proper port, or reinstall the software, choosing the new connection type you are using.
- 10 If the problem is still not resolved, see [“Solving general printing problems” on page 92](#).

## Checking the network

It is recommended that you use the HP Color LaserJet 2500 CD-ROM to install and set up the printer on a network. Follow these steps to see if the problem is caused by the network.

- When you printed the Configuration page, an HP Jetdirect configuration page should have printed if an HP Jetdirect print server card is installed. (If these pages do not print in your language, see [“Special pages” on page 56](#).) Verify that all network settings are properly configured. For more information about the HP Jetdirect page, see the HP Jetdirect Print Server Administrator’s Guide, which can be installed from the **View Documentation** or **User Documentation** sections on the HP Color LaserJet 2500 CD-ROM.
- See the HP Jetdirect Print Server Administrator’s Guide, which can be installed from the **View Documentation** or **User Documentation** sections on the HP Color LaserJet 2500 CD-ROM.
- Contact your network administrator for assistance.

## Solving general printing problems

In addition to the problems listed in this section, see [“Solving common Macintosh problems” on page 97](#) if you are using a Macintosh computer and see [“Solving PostScript \(PS\) errors” on page 96](#) if you are using several printer languages.

Symptom	Possible Cause	Solution
The print job is extremely slow.	The job might be very complex, if it contains graphics, for example.	<ul style="list-style-type: none"><li>• Wait for the job to print.</li><li>• Reduce the complexity of the page or try adjusting the print quality settings. If this problem occurs frequently, add memory to the printer.</li></ul>
	The maximum speed of 16 ppm in black and 4 ppm in color and cannot be exceeded even when more memory is added.	Wait for the print job to finish.
	Printing speeds might be automatically reduced when printing special-sized media.	Wait for the print job to finish.
	In the printer driver, the Type or Size is set for card stock or other heavy paper.	<ul style="list-style-type: none"><li>• If you are printing on heavy paper, the Type or Size should be set to a heavy paper setting. The printer prints more slowly to provide better quality. Wait for the job to print.</li><li>• If you are not printing on heavy paper, set Type or Size in the printer driver to plain paper.</li><li>• In the default settings for this printer, select the <b>Paper</b> tab and ensure that Type is set to plain paper. You can override this setting from the printer driver when you print on heavy paper.</li></ul>
	There might be an issue with the driver.	<ul style="list-style-type: none"><li>• If you were printing using the PCL driver, print using the PS driver, or vice versa.</li></ul>
The printer pulls paper or print media from the wrong tray.	The Source (tray) selection might be incorrect.	<ul style="list-style-type: none"><li>• For Windows, ensure that the Source is selected from the <b>Print</b> dialog box (which is part of the program) if possible or from the printer driver. If you select the Source in the printer driver and then select a different Source in the <b>Print</b> dialog box, the Source setting in the printer driver changes to match the Source setting in the <b>Print</b> dialog box.</li><li>• For Macintosh, set the Source in the <b>Print</b> dialog box.</li><li>• Remove any paper from other trays to make the printer select from the desired tray.</li></ul>
	The <b>Type</b> or <b>Size</b> setting does not match the size of paper or print media loaded in the tray.	Using the embedded Web server, change the <b>Type</b> or <b>Size</b> setting for the tray to match the size of print media loaded.
	Paper is loaded in tray 1.	Remove any paper from tray 1. The printer pulls from tray 1 if you did not specify a tray that had a compatible size or type loaded and tray 1 is unconfigured.

Symptom	Possible Cause	Solution
Printer does not pull paper from tray 2 or optional tray 3.	The rear paper length guide (tray 2) or the rear paper stop (optional tray 3) is set incorrectly.	To set the rear guides properly, see <a href="#">“Loading optional tray 2” on page 32</a> or <a href="#">“Loading optional tray 3” on page 33</a> .
	The tray is not recognized in the printer software.	Set the printer software to recognize the tray.
	If the printer does not pull paper from either tray, the problem might be the paper.	<ul style="list-style-type: none"> <li>● Try a different type or brand of paper.</li> <li>● Ensure that you are using a high-quality paper made for laser printers. Coated, photo, and glossy papers are not supported. See <a href="#">“Print media specifications” on page 123</a>. To order, see <a href="#">“Accessories and ordering information” on page 24</a>.</li> </ul>
	The separation pad and the pick-up rollers might be worn out.	Replace the separation pad and pick-up rollers. Contact HP Customer Care to order parts. See <a href="#">“HP Customer Care” on page 3</a> or see the support flyer that shipped in the printer box.
The printer does not recognize a DIMM that is installed.	The DIMM is not recognized in the printer software.	Set the printer software to recognize the DIMM. See <a href="#">“Enabling memory” on page 138</a> .
The printer does not respond when the <b>Print</b> command is selected in the software.	The printer experienced an error.	Check the control panel lights on the printer to determine if an error exists.
	If no control panel lights are on, the printer is not receiving power.	<ul style="list-style-type: none"> <li>● Check the power cable connection between the printer and the power source.</li> <li>● Check that the power switch is on.</li> <li>● Check that the power source (outlet or surge protector) is receiving power.</li> <li>● If none of the above measures works, contact HP Customer Care. See <a href="#">“HP Customer Care” on page 3</a> or see the support flyer that shipped in the printer box.</li> </ul>
	The printer might be in Manual Feed mode (Attention light blinking and Go light on).	Add paper to tray 1 if it is empty. If paper is already in the tray, press  (Go).
	The wrong printer was selected in the software.	In the <b>Print</b> or <b>Printer Setup</b> dialog box, make sure that the HP Color LaserJet 2500 is selected as the printer.
	There might be a jam.	Clear any jams. See <a href="#">“Clearing jams” on page 66</a> .
	The printer is on a network and is not receiving a signal.	<ul style="list-style-type: none"> <li>● Disconnect the printer from the network and attach it directly to a computer using a parallel or USB cable.</li> <li>● Clear any stopped jobs from the print queue.</li> <li>● Print a job that you know works.</li> <li>● Reinstall the printing software.</li> </ul>
	The interface cable between the computer (or network) and the printer is not connected properly.	Disconnect and reconnect the interface cable.
	The interface cable is defective.	<ul style="list-style-type: none"> <li>● If possible, connect the interface cable to another computer (or network port) and print a job you know works.</li> <li>● Try using a different cable.</li> </ul>
	If the printer is connected to a computer, the software for the printer is not configured for the printer port.	Check the printer selection menu in the software to make sure it is accessing the correct port. If the computer has more than one port, make sure that the printer is associated with the correct one.

Symptom	Possible Cause	Solution
Pages print, but all colors do not print or the pages are completely blank.	If pages print completely blank, the file might have blank pages.	Check the file to make sure that it does not contain blank pages.
	A print cartridge might be low or empty.	Check the printer control panel for a Supplies Status message, print a Supplies Status page, or use the embedded Web server to see the levels remaining in the print cartridges. Replace any print cartridges that are low or empty. Messages are not created for non-HP print cartridges.
	If you are using non-HP print cartridges, one or more print cartridges is low or empty. The control panel lights do not indicate low or empty for non-HP print cartridges.	Replace one or more of the print cartridges.
The paper curls when exiting the top output bin.	The <b>Font DIMM</b> check box might be checked but the font DIMM is not physically installed in the printer. (This issue only applies to printers using an Asian-language font DIMM.)	In the settings for this printer, clear the <b>Font DIMM</b> check box on the <b>Configure</b> tab if no font DIMM is installed in the printer. Select the <b>Font DIMM</b> check box only if the font DIMM is physically installed in the printer. If you think that the font DIMM is installed, make sure that it is installed correctly.
	The paper needs to print to the straight-through paper path.	Open the rear output door to print to the straight-through paper path. Remove each sheet as it exits the printer.
	The stack was slightly curled when it was placed in the tray.	Turn the stack over in the tray.
	The paper does not meet specifications.	See <a href="#">"Print media specifications" on page 123</a> .
	If you are printing on light media, the Type setting may not be correct.	Select <b>Light</b> in the <b>Type is</b> field in the printer driver.



Symptom	Possible Cause	Solution
The printer prints, but the text is wrong, garbled, or incomplete.	The interface cable is loose or defective.	Disconnect the printer cable and reconnect it. Try a print job you know works. If possible, attach the cable and printer to another computer and try a print job that you know works. Finally, try a new cable.
	The printer is on a network or sharing device and is not receiving a clear signal.	Disconnect the printer from the network and attach it directly to a computer with a parallel or USB cable. Print a job that you know works.
	The wrong driver was selected in the software.	In the <b>Print</b> or <b>Printer Setup</b> dialog box, make sure that the HP Color LaserJet 2500 is selected as the printer.
	The printer driver is malfunctioning.	Print a page from the HP Color LaserJet 2500 Toolbox. If the page prints, then the problem is with the printer driver. Uninstall and reinstall the printer driver.
	The program is malfunctioning.	Try printing a job from another program.
	If the printer is connected to a computer, the operating system is malfunctioning.	<p>Check the operating system. If you do not know how to use the method below, see the documentation that came with the computer.</p> <p>Restart the computer. When it beeps during startup, press <b>F5</b> and select <b>Command Prompt Only</b>. At the C:\ prompt on the computer, type <code>Dir&gt;LPT1</code> and then press <b>ENTER</b>. (This assumes the printer is connected to LPT1.) If the Go light comes on at the printer, press  (<b>GO</b>) to print and eject the page. If the page prints correctly, then the operating system is malfunctioning.</p>
The font DIMM check box might be selected but the font DIMM might not be physically installed in the printer. (This issue only applies to printers with an Asian-language font DIMM installed.)	<ul style="list-style-type: none"> <li>• If the font DIMM is not installed in the printer, open the printer driver and on the <b>Configure</b> tab, clear the <b>font DIMM</b> check box.</li> <li>• If a font DIMM is installed, leave the check box selected, but ensure that the actual font DIMM is installed correctly in the printer.</li> </ul>	

## Solving PostScript (PS) errors

The following situations are specific to PS language and might occur when several printer languages are being used.

---

**Note** To receive a printed or an on-screen message when PS errors occur, choose this option in the PS printer driver or the embedded Web server.



---

Symptom	Possible Cause	Solution
The job prints in Courier (the printer default typeface) instead of the typeface you requested.	The requested typeface is not downloaded. A personality switch might have been performed to print a PCL job just before the PS printing job was received.	Download the desired font and send the print job again. Verify the type and location of the font. Download the font to printer, if applicable. See the software documentation.
A PS error page prints.	Print job might not be PS.	Make sure the print job is a PS job. Check to see whether the program expected a setup or PS header file to be sent to the printer.
VM Error	This is a PS font error that occurs when you are using several fonts.	Select Unlimited Downloadable Fonts from the printer driver.
Range Check	This is a PS font error that occurs when you are using several fonts.	<ul style="list-style-type: none"><li>• Try printing from a different tray.</li><li>• Select Unlimited Downloadable Fonts from the printer driver.</li></ul>

---

# Solving common Macintosh problems

In addition to the problems listed in “[Solving general printing problems](#)” on page 92, this section lists problems that can happen only when using the Mac OS, versions 8.6 to 9.x.

Symptom	Possible Cause	Solution
<b>Problems in the Chooser</b>		
The printer driver icon does not appear in the Chooser.	Software was not installed correctly.	The LaserWriter driver should be present as a part of the Mac OS. Make sure that the LaserWriter driver is in the Extensions folder within the systems folder. If not, install the LaserWriter driver from your Mac OS CD-ROM.
	The interface cable might not be high quality.	Make sure that you are using a high-quality interface cable.
	An incorrect network might be selected.	Make sure that the printer is on the correct network. Select the <b>Network</b> or <b>AppleTalk Control Panel</b> from <b>Control Panels</b> in the <b>Apple</b> menu and then choose the correct network.
The printer name does not appear in the <b>Select a PostScript Printer</b> box in the Chooser.	The printer might not be ready.	Make sure that the cables are connected correctly, the printer is on, and the Ready light is on.
	The correct printer driver might not be selected.	Make sure that the correct printer driver has been selected in the Chooser.
	An incorrect zone might be selected.	If the printer resides on a network with multiple zones, make sure that the correct zone is selected in the <b>AppleTalk Zones</b> box in the Chooser.
	The PS driver might not be installed.	Verify that the PS driver is installed.
	The printer might not be selected in the Chooser.	Make sure that the printer has been chosen in the Chooser by printing a Configuration page. [Simultaneously press  (GO) and  (CANCEL JOB) on the printer.] Check the AppleTalk name of the printer displayed on the Configuration page.
	AppleTalk might be off.	Make sure that AppleTalk is on. (The button next to <b>Active</b> is selected in the Chooser.) You might need to restart the computer to activate the change.
The printer driver does not automatically set up your selected printer even though you clicked <b>Auto Setup</b> in the Chooser.		Reinstall the printer software. See the getting started guide.
<b>Printing Errors</b>		
A print job was not sent to the printer that you wanted.	Another printer with the same or similar name might have received your print job.	<ul style="list-style-type: none"><li>• Check the AppleTalk name of the printer displayed on the Configuration page.</li><li>• Make sure that the cables are connected correctly, the printer is on, and the Ready light is on.</li></ul>
You cannot use the computer while the printer is printing.	Background Printing has not been selected.	LaserWriter 8.6 and later: Turn Background Printing on by selecting <b>Print Desktop</b> on the <b>File</b> menu and then clicking <b>Background Printing</b> .
An encapsulated PostScript (EPS) file does not print with the correct fonts.	This problem occurs with some programs.	<ul style="list-style-type: none"><li>• Try downloading the fonts contained in the EPS file to the printer before printing.</li><li>• Send the file in ASCII format instead of binary encoding.</li></ul>

Symptom	Possible Cause	Solution
Your document is not printing with New York, Geneva, or Monaco fonts.	The printer might be substituting fonts.	Select <b>Options</b> in the <b>Page Setup</b> dialog box to clear substituted fonts.
<b>USB Problems</b>		
You are unable to print from a third-party USB card.	This error occurs when the software for USB printers is not installed.	When adding a third-party USB card, you might need the Apple USB Adapter Card Support software. The most current version of this software is available from the Apple website.
When connected using a USB cable, the printer does not appear in the Macintosh Chooser after the driver is selected.	This problem is caused by either a software or hardware component.	<p><b>Software troubleshooting</b></p> <ul style="list-style-type: none"> <li>• Check that your Macintosh supports USB.</li> <li>• Verify if your Macintosh has Mac OS 8.6 or later.</li> <li>• Ensure that your Macintosh has the appropriate USB software from Apple.</li> </ul> <p><b>Note:</b> The iMac and Blue G3 desktop Macintosh systems meet all the requirements to connect to a USB device.</p> <p><b>Hardware troubleshooting</b></p> <ul style="list-style-type: none"> <li>• Check that the printer is turned on.</li> <li>• Verify that the USB cable is properly connected.</li> <li>• Check that you are using the appropriate high-speed USB cable.</li> <li>• Ensure that there are not too many USB devices drawing power from the chain. Disconnect all devices from the chain and connect the cable directly to the USB port on the host computer.</li> <li>• Check to see if more than two nonpowered USB hubs are connected in a row on the chain. Disconnect all devices from the chain and connect the cable directly to the USB port on the host computer.</li> </ul> <p><b>Note:</b> The iMac keyboard is a nonpowered USB hub.</p>

## Cleaning the printer

During the printing process, paper, toner and dust particles can accumulate inside the printer. Over time, this buildup can cause print-quality problems such as toner specks or smearing. This printer has a cleaning mode that can correct and prevent these types of problems.

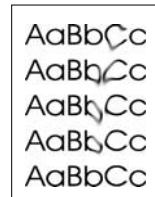
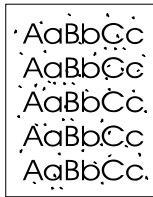

### To clean the engine

#### Note

The following procedure must be performed from the HP Color LaserJet 2500 Toolbox, which is only supported for Windows 98 and later. To clean the engine when the computer is running a different, supported operating system, see the late-breaking Readme on the root of the CD-ROM, or visit <http://www.hp.com/support/clj2500>.

- 1 Make sure the printer is turned on and in the Ready state.
- 2 Open the HP Color LaserJet 2500 Toolbox.
- 3 On the **Troubleshooting** tab, click **Cleaning Page** and click **Print**. A page with a pattern prints from the printer.
- 4 At the printer, remove any paper that might be in tray 1.
- 5 Remove the page that printed and load it face down into tray 1.

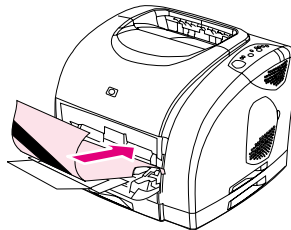

- 6 At the computer, press **Clean**.

## Calibrating the printer

The printer automatically calibrates when a supply is changed and at set intervals determined by the total number of pages the printer has printed. You can change when the printer performs automatic calibrations using the embedded Web server.

You can also calibrate the printer manually when you are having color-related issues.

### To calibrate the printer at the printer

- 1 Turn the printer off and then on again.

### To calibrate the printer from the HP Color LaserJet 2500 Toolbox

- 1 Open the HP Color LaserJet 2500 Toolbox in one of these ways:
  - On the desktop, double-click the **HP Color LaserJet 2500 Toolbox** icon.
  - On the **Start** menu, point to **Programs**, point to **HP Color LaserJet 2500**, and choose the **HP Color LaserJet 2500 Toolbox**.
- 2 On the **Troubleshooting** tab, click **Diagnostic Tools** (on the left side of the screen).
- 3 Click **Color Calibration**.

# Managing supplies

For warranty information about these supplies, see [“Limited warranty for the print cartridges and imaging drum” on page 107](#).

## Supplies life

The life of the imaging drum depends on the number of black-only or color pages that print jobs require. An HP Color LaserJet 2500 series imaging drum lasts an average of 20,000 pages when printing black-only pages and 5,000 pages when printing color pages. Actual life lies somewhere between these two numbers, depending on the number of black-only pages you print versus color. The average life is between 6,000 and 8,000 pages.

The life of a print cartridge depends on the amount of toner that print jobs require. When printing text at 5 percent coverage, an HP Color LaserJet 2500 series cyan, magenta, or yellow print cartridge lasts an average of 4,000 pages, and a black print cartridge lasts an average of 5,000 pages.

## Checking and ordering supplies

You can check the supplies state using the printer control panel, printing a Supplies Status page, viewing the embedded Web server, viewing Printer Status and Alerts, or viewing HP Web Jetadmin. HP recommends that you place an order for a replacement print cartridge when you first receive the Low message for a print cartridge. The Low message indicates that approximately two weeks of life remains. When you use a new, authentic HP print cartridge or imaging drum, you can obtain the following types of supplies information:

- amount of cartridge or drum life remaining
- estimated number of pages remaining
- number of pages printed
- other supplies information

---



### Note

If the printer is connected to the network, you can set the embedded Web server to notify you by e-mail when a print cartridge or the imaging drum is low. If the printer is directly connected to a computer, you can set Printer Status and Alerts to notify you when supplies are low.

---

## To check status and order using the control panel

Do one of the following:

- Check the supplies status lights on the printer control panel. These lights indicate when a print cartridge or the imaging drum is low or empty. The lights also indicate when a non-HP print cartridge is first installed. See [“Supplies Status lights” on page 72](#) to interpret the light patterns.
- Press  (Go) and  (CANCEL JOB) simultaneously. A Supplies Status page (and the Configuration page, and possibly the HP Jetdirect page) prints. Check the supplies levels on the Supplies Status page. See [“Special pages” on page 56](#) for more information.

If the supplies levels are low, you can order supplies through your local HP dealer, by telephone, or online. See [“Accessories and ordering information” on page 24](#) for part numbers. See <http://www.hp.com/go/ljsupplies> to order online.

## To check and order using the embedded Web server

- 1 Open the embedded Web server.
- 2 On **Information** tab, click **Device Status** (on the left side of the window). Click **Supplies Status** to see more information, such as part numbers.
- 3 If the print cartridges are low or empty, you can click **Order Supplies** in the **Other Links** area. This opens a browser and connects you to the Supplies section of the HP website. You must have Internet access to connect to the website.

---

### Note

You can click the **Order Supplies** link from the HP Color LaserJet 2500 Toolbox also. You must have Internet access to connect to the website.

## To check and order using Printer Status and Alerts

If the printer is directly connected to the computer, you can set Printer Status and Alerts to notify you when the supplies are low. On both directly connected and network printers, you can receive messages that supplies are low or empty if you choose to receive alerts about events that do not prevent the printer from printing (a print cartridge is low) or that do prevent the printer from printing (a print cartridge is empty). After receiving a message, click **Order Supplies Online** in Printer Status and Alerts to connect to the Supplies section of the HP website. You must have Internet access to connect to the website.

## To check and order using HP Web Jetadmin

In HP Web Jetadmin, select the printer device. The device status page shows supplies information. To order, use the HP Color LaserJet 2500 Toolbox or the embedded Web server. Or, see [“Accessories and ordering information” on page 24](#).

## Storing supplies

Follow these guidelines for storing print cartridges and the imaging drum:

- Do not remove the print cartridge or imaging drum from its package until you are ready to use it.

---

### CAUTION

To prevent damage, do not expose the print cartridge or imaging drum to light for more than a few minutes.

- See [“Environmental specifications” on page 115](#) for operating and storage temperature ranges.
- Store the supply in a horizontal position.
- Store the supply in a dark, dry location away from heat and magnetic sources.

## Replacing and recycling supplies

To install a new HP print cartridge or imaging drum and recycle the used one, follow the instructions included in the box containing the new supply, or see the getting started guide. See [“HP LaserJet printing supplies” on page 117](#) for more information about recycling.



## HP policy on non-HP supplies

Hewlett-Packard Company cannot recommend the use of non-HP supplies, either new or remanufactured. Because they are not HP products, HP cannot influence their design or control their quality. Service or repairs required as a result of using a non-HP supply will *not* be covered under the printer warranty.

When you insert a supply into the printer, the printer will inform you if the supply is not a genuine HP supply. If you insert a genuine HP supply that has reached the low state from another HP printer, the printer identifies the supply as non-HP. Simply return the supply to the original printer to reactivate HP features and functionality.

### Resetting the printer for non-HP supplies

When you install a non-HP print cartridge or imaging drum, the light next to the print cartridge or imaging drum you replaced blinks and the Attention light is on. You must press  (CANCEL JOB) the first time you install this non-HP supply. The status lights will not indicate when this type of supply is low or empty.

---

#### CAUTION

The printer will not stop printing when this type of supply is empty. Printer damage could occur if the printer prints with an empty print cartridge or imaging drum. See [“Hewlett-Packard limited warranty statement” on page 106](#) and [“Limited warranty for the print cartridges and imaging drum” on page 107](#).

---

## HP fraud hotline

Call the HP fraud hotline if the supplies status lights, the embedded Web server, or HP Status and Alerts indicates that the print cartridge or imaging drum is not an HP print cartridge and you think that it is genuine. HP will help determine if the product is genuine and take steps to resolve the problem.

Your print cartridge or imaging drum might not be a genuine HP one if you notice the following issues:

- You are experiencing a high number of problems with the print cartridge or imaging drum.
- The print cartridge or imaging drum does not look like it usually does (for example, the pull tab or the box is different).

*In the United States*, call toll-free: 1-877-219-3183.

*Outside the United States*, you can call collect. Dial the operator and ask to place a collect call to this telephone number: 1-770-263-4745. If you do not speak English, a representative at the HP fraud hotline who speaks your language will assist you. Or, if someone who speaks your language is not available, a language line interpreter will connect approximately one minute after the beginning of the call. The language line interpreter is a service that will translate between you and the representative for the HP fraud hotline.



# A Service and support

## Introduction

This section contains support and service information.

- [“Hewlett-Packard limited warranty statement” on page 106](#)
- [“Limited warranty for the print cartridges and imaging drum” on page 107](#)
- [“Availability of support and service” on page 108](#)
- [“HP maintenance agreements” on page 108](#)
- [“HP Express Exchange \(U.S. and Canada only\)” on page 109](#)
- [“Repacking the printer” on page 110](#)

# Hewlett-Packard limited warranty statement

## HP PRODUCT

HP Color LaserJet 2500L, 2500, 2500n, 2500tn

## DURATION OF WARRANTY

1 year, [Return to Authorized Service Center](#)

1. HP warrants to you, the end-user customer, that HP hardware and accessories will be free from defects in materials and workmanship after the date of purchase, for the period specified above. If HP receives notice of such defects during the warranty period, HP will, at its option, either repair or replace products which prove to be defective. Replacement products may be either new or equivalent in performance to new.
2. HP warrants to you that HP software will not fail to execute its programming instructions after the date of purchase, for the period specified above, due to defects in material and workmanship when properly installed and used. If HP receives notice of such defects during the warranty period, HP will replace software which does not execute its programming instructions due to such defects.
3. HP does not warrant that the operation of HP products will be uninterrupted or error free. If HP is unable, within a reasonable time, to repair or replace any product to a condition as warranted, you will be entitled to a refund of the purchase price upon prompt return of the product.
4. HP products may contain remanufactured parts equivalent to new in performance or may have been subject to incidental use.
5. Warranty does not apply to defects resulting from (a) improper or inadequate maintenance or calibration, (b) software, interfacing, parts or supplies not supplied by HP, (c) unauthorized modification or misuse, (d) operation outside of the published environmental specifications for the product, or (e) improper site preparation or maintenance.
6. TO THE EXTENT ALLOWED BY LOCAL LAW, THE ABOVE WARRANTIES ARE EXCLUSIVE AND NO OTHER WARRANTY OR CONDITION, WHETHER WRITTEN OR ORAL, IS EXPRESSED OR IMPLIED AND HP SPECIFICALLY DISCLAIMS ANY IMPLIED WARRANTIES OR CONDITIONS OF MERCHANTABILITY, SATISFACTORY QUALITY, AND FITNESS FOR A PARTICULAR PURPOSE. Some countries/regions, states or provinces do not allow limitations on the duration of an implied warranty, so the above limitation or exclusion might not apply to you. This warranty gives you specific legal rights and you might also have other rights that vary from country/region to country/region, state to state, or province to province.
7. HP's limited warranty is valid in any country/region or locality where HP has a support presence for this product and where HP has marketed this product. The level of warranty service you receive may vary according to local standards. HP will not alter form, fit or function of the product to make it operate in a country/region for which it was never intended to function for legal or regulatory reasons.
8. TO THE EXTENT ALLOWED BY LOCAL LAW, THE REMEDIES IN THIS WARRANTY STATEMENT ARE YOUR SOLE AND EXCLUSIVE REMEDIES. EXCEPT AS INDICATED ABOVE, IN NO EVENT WILL HP OR ITS SUPPLIERS BE LIABLE FOR LOSS OF DATA OR FOR DIRECT, SPECIAL, INCIDENTAL, CONSEQUENTIAL (INCLUDING LOST PROFIT OR DATA), OR OTHER DAMAGE, WHETHER BASED IN CONTRACT, TORT, OR OTHERWISE. Some countries/regions, states or provinces do not allow the exclusion or limitation of incidental or consequential damages, so the above limitation or exclusion may not apply to you.

THE WARRANTY TERMS CONTAINED IN THIS STATEMENT, EXCEPT TO THE EXTENT LAWFULLY PERMITTED, DO NOT EXCLUDE, RESTRICT OR MODIFY AND ARE IN ADDITION TO THE MANDATORY STATUTORY RIGHTS APPLICABLE TO THE SALE OF THIS PRODUCT TO YOU.

## Limited warranty for the print cartridges and imaging drum

This HP product is warranted to be free from defects in materials and workmanship during its useful life (end of life is indicated by a printer control panel low-life message).

This warranty does not cover products that have been modified, refurbished, remanufactured, misused or tampered with in any way.

This limited warranty gives you specific legal rights. You may have other rights which vary from state to state, province to province and country/region to country/region.

THE ABOVE WARRANTIES ARE EXCLUSIVE AND NO OTHER WARRANTY, WHETHER WRITTEN OR ORAL, IS EXPRESSED OR IMPLIED. THE HEWLETT-PACKARD COMPANY SPECIFICALLY DISCLAIMS THE IMPLIED WARRANTIES OR MERCHANTABILITY AND FITNESS FOR A PARTICULAR PURPOSE. TO THE EXTENT ALLOWED BY APPLICABLE LAW, IN NO EVENT SHALL HEWLETT-PACKARD COMPANY BE LIABLE FOR ANY INCIDENTAL, CONSEQUENTIAL, SPECIAL, INDIRECT, PUNITIVE, OR EXEMPLARY DAMAGES OR LOST PROFITS FROM ANY BREACH OF THIS WARRANTY OR OTHERWISE.

In the event that your product proves to be defective, please return to place of purchase with a written description of the problem.

## Availability of support and service

Around the world, HP provides a variety of service and support options for purchase. Availability of these programs will vary depending upon your location.

## HP maintenance agreements

HP has several types of maintenance agreements that meet a wide range of support needs. Maintenance agreements are not part of the standard warranty. Support services vary by area. Contact HP Customer Care to determine the services available to you and for more information about maintenance agreements. In general, the printer will have the following maintenance agreements:

### **On-site service agreements**

To provide you with the level of support best suited to your needs, HP has on-site service agreements with three response times:

#### **Priority On-Site Service**

This agreement provides 4-hour service response to your site for calls made during normal HP business hours.

#### **Next-Day On-Site Service**

This agreement provides support by the next working day following a service request. Extended coverage hours and extended travel beyond HP's designated service zones are available on most on-site agreements (for additional charges).

#### **Weekly (Volume) On-Site Service**

This agreement provides scheduled weekly on-site visits for organizations that use many HP products. This agreement is designated for sites using 25 or more workstation products, including printers, plotters, computers, and disk drives.

## HP Express Exchange (U.S. and Canada only)

This service, available for an additional fee, is an alternative to the standard warranty and entails returning your printer for repair. HP Express Exchange allows you to receive a refurbished replacement unit and then return your defective printer. The fast turnaround from HP Express Exchange minimizes downtime over traditional service programs that require you to ship the defective printer to the manufacturer and then wait for the printer to be repaired and returned.

If you choose to use this service, follow the steps listed below. If you have HP on-site support service, you should work directly with the local HP Customer Care instead of following the steps outlined here.

### To use HP Express Exchange

- 1** Call the HP Customer Care Center for the U.S. or Canada. A technician troubleshoots the situation and determines whether the printer has actually failed. If so, the technician refers the customer to the HP Service Center.
- 2** A representative from the service center requests product and customer information. In some cases, collateral might also be requested.
- 3** Before agreeing to use this service, check with the representative regarding the current cost to you for returning your defective printer.
- 4** HP ships a refurbished replacement unit to arrive the next day. (Geographic distance might prevent next-day shipping.)
- 5** You send the defective printer to Hewlett-Packard at your expense. The HP representative can tell you the cost. (See step 3.)

Exchanged units carry the remainder of the original unit's warranty or 90 days, whichever is greater.

# Repacking the printer

If HP Customer Care determines that your printer needs to be returned to HP for repair, follow the steps below to repack the printer before shipping it.

---

**CAUTION**

---

Shipping damage as a result of inadequate packing is the customer's responsibility.

## To repack the printer

- 1 Remove and retain any DIMMs installed in the printer.

---

**CAUTION**

---

Static electricity can damage DIMMs. When handling DIMMs, either wear an antistatic wrist strap, or frequently touch the surface of the DIMM antistatic package and then touch bare metal on the printer. To remove the DIMMs, see ["Installing memory and font DIMMs" on page 135](#).

- 2 Remove and retain the imaging drum.
- 3 Remove and retain all four print cartridges. To remove them:
  - a Open the top cover and remove the print cartridge that is in the access position.
  - b Close the top cover and press **ROTATE CAROUSEL** .
  - c Open the top cover and remove the print cartridge that is now in the access position.
  - d Repeat steps b and c to remove the two remaining print cartridges.

---

**CAUTION**

---

It is *extremely important* to remove the print cartridges before shipping the printer. Print cartridges left in the printer during shipping will leak and entirely cover the printer engine and other parts with toner.

To prevent damage to the print cartridge, avoid touching the roller on it, and store the print cartridge in its original packing material or so that it is not exposed to light.

- 4 If the problem does not involve optional tray 2 or optional tray 3, remove and retain the tray or trays.
- 5 Remove and retain the power cable, interface cable, and optional accessories.
- 6 Remove and retain the HP Jetdirect print server card.
- 7 If possible, include print samples and 50 to 100 sheets of paper or other print media that did not print correctly.
- 8 Include a completed copy of the ["Service information form" on page 111](#).
- 9 Use the original shipping container and packing material, if possible. *If you have already disposed of the printer packing material, contact a local mailing service for information about repacking the printer.* HP recommends insuring the equipment for shipment.



## Service information form

<b>WHO IS RETURNING THE EQUIPMENT?</b>		Date: _____
Person to contact: _____		Phone: _____
Alternate contact: _____		Phone: _____
Return shipping address:	Special shipping instructions:	
<b>WHAT ARE YOU SENDING?</b>		
Model name: _____	Model number: _____	Serial number: _____
Please attach any relevant printouts. Do NOT ship accessories (manuals, cleaning supplies, etc.) that are not required to complete the repair.		
<b>HAVE YOU REMOVED THE PRINT CARTRIDGES AND IMAGING DRUM?</b>		
You <i>must</i> remove them before shipping the printer, unless a mechanical problem prevents you from doing so.		
<input type="checkbox"/> Yes. <span style="margin-left: 150px;"><input type="checkbox"/> No, I cannot remove them.</span>		
<b>WHAT NEEDS TO BE DONE?</b> (Attach a separate sheet if necessary.)		
1. Describe the conditions of the failure. (What was the failure? What were you doing when the failure occurred? What software were you running? Is the failure repeatable?)		
2. If the failure is intermittent, how much time elapses between failures? _____		
3. If the unit connected to any of the following, give the manufacturer and model number.		
Personal computer: _____	Modem: _____	Network: _____
4. Additional comments:		
<b>HOW WILL YOU PAY FOR THE REPAIR?</b>		
<input type="checkbox"/> Under warranty      Purchase/received date: _____ <small>(Attach proof of purchase or receiving document with original received date.)</small>		
<input type="checkbox"/> Maintenance contract number: _____		
<input type="checkbox"/> Purchase order number: _____		
<b>Except for contract and warranty service, a purchase order number and/or authorized signature must accompany any request for service.</b> If standard repair prices do not apply, a minimum purchase order is required. Standard repair prices can be obtained by contacting an HP-authorized repair center.		
Authorized signature: _____		Phone: _____
Billing address:	Special billing instructions:	



# B Specifications and regulatory information

## Introduction

This section contains information regarding printer specifications and required regulatory information. These topics are:

- “Printer specifications” on page 114
- “Environmental Product Stewardship program” on page 116
- “FCC regulations” on page 119
- “Regulatory statements” on page 120

## Printer specifications

Physical specifications	HP LaserJet 2500 without optional trays 2 and 3	HP LaserJet 2500 with optional tray 2 (250-sheet)	HP LaserJet 2500 with optional tray 3 (500-sheet)
Height	325 mm (12.80 in.)	376 mm (14.80 in.)	512 mm (20.16 in.)
Width	482 mm (18.98 in.)	482 mm (18.98 in.)	482 mm (18.98 in.)
Depth (body)	451 mm (17.76 in.)	451 mm (17.76 in.)	451 mm (17.76 in.)
Weight (with supplies)	21.5 kg (47.5 lbs)	23.9 kg (52.7 lbs)	29.3 kg (64.6 lbs)

### Supplies specifications

Imaging-drum life	20,000 pages when printing only in black. 5,000 pages when printing in color. 6,000 to 8,000 pages is the average life.
Print-cartridge life	Black: 5,000 pages. Yellow, cyan, and magenta: 4,000 pages each.

Electrical specifications	110-volt models	220-volt models
Power requirements	115 to 127 V (+/- 10%) 60 Hz (+/- 2 Hz)	220 to 240 V (+/- 10%) 50 Hz (+/- 2 Hz)
Minimum recommended circuit capacity for typical product	12 Amps	6 Amps
Average power consumption (watts) — HP Color LaserJet 2500 series printers	Printing, four color = 224 W Printing, one color = 400 W Standby = 30 W Off = 0 W	Printing, four color = 217 W Printing, one color = 403 W Standby = 31 W Off = 0 W

### CAUTION

Power requirements are based on the country/region where the printer is sold. Do not convert operating voltages. This will damage the printer and void the product warranty.

<b>Environmental specifications</b>	<b>Recommended</b>	<b>Operating</b>	<b>Storage</b>
Temperature (printer and print cartridge)	20° to 27° C (68° to 81° F)	15° to 32.5° C (59° to 90.5° F)	-20° to 40° C (-4° to 104° F)
Relative humidity	20 to 70%	10 to 80%	95% or less

**Acoustic Emissions  
(HP Color LaserJet 2500  
series printers)**

<b>Bystander Position</b>	<b>Declared Per ISO 9296</b>
Printing (16 ppm)	$L_{pAm} = 57 \text{ dB(A)}$
Standby	not audible
<b>Sound Power</b>	<b>Declared Per ISO 9296</b>
Printing (16 ppm)	$L_{WAd} = 6.6 \text{ bels(A)}$
Standby	not audible

Values are subject to change. See <http://www.hp.com/support/clj2500> for current information.

# Environmental Product Stewardship program

## Protecting the environment

Hewlett-Packard Company is committed to providing quality products in an environmentally sound manner. This product has been designed with several attributes to minimize impacts on our environment.

## Ozone production

This product generates no appreciable ozone gas (O<sub>3</sub>).

## Energy consumption

**This product qualifies for ENERGY STAR®, which is a voluntary program established to encourage the development of energy-efficient office products.**



ENERGY STAR is a U.S. registered service mark of the U.S. Environmental Protection Agency. As an ENERGY STAR® partner, Hewlett-Packard Company has determined that this product meets ENERGY STAR® Guidelines for energy efficiency. For more information, see <http://www.energystar.gov/>.

## Paper use

The manual duplex feature [two-sided printing; see “[Printing on both sides \(duplexing manually\)](#)” on page 48] and N-up printing capability [multiple pages printed on one sheet; see “[Printing multiple pages on one sheet of paper \(N-up printing\)](#)” on page 40] can reduce paper usage and the resulting demands on natural resources.

## Plastics

Plastic parts over 25 grams are marked according to international standards that enhance the ability to identify plastics for recycling purposes at the end of the product’s life.

## HP LaserJet printing supplies

In many countries/regions, this product's printing supplies (for example, print cartridge, imaging drum) can be returned to HP through the HP Printing Supplies Returns and Recycling Program. An easy-to-use and free takeback program is available in over 48 countries/regions. Multi-lingual program information and instructions are included in every new HP LaserJet print cartridge and supplies package.

## HP Printing Supplies Returns and Recycling Program Information

Since 1990, the HP Printing Supplies Returns and Recycling Program has collected more than 47 million used HP LaserJet print cartridges that otherwise may have been discarded in the world's landfills. The HP LaserJet print cartridges and supplies are collected and bulk shipped to our resource and recovery partners who disassemble the cartridge. After a thorough quality inspection, selected parts are reclaimed for use in new cartridges. Remaining materials are separated and converted into raw materials for use by other industries to make a variety of useful products.

### U.S. returns

For a more environmentally responsible return of used cartridges and supplies, HP encourages the use of bulk returns. Simply bundle two or more cartridges together and use the single, pre-paid, pre-addressed UPS label that is supplied in the package. For more information in the U.S., call (1) (800) 340-2445 or visit the HP Printing Supplies Returns and Recycling Program website at: <http://www.hp.com/go/recycle>.

### Non-U.S. returns

Non-U.S. customers should call the local HP Sales and Service Office or visit the <http://www.hp.com/go/recycle> website for further information regarding availability of the HP Printing Supplies Returns and Recycling Program.

## Paper

This product is capable of using recycled papers, when the paper meets the guidelines outlined in the *HP LaserJet Printer Family Print Media Guide*. See “[Supplementary Documentation](#)” on [page 25](#) for ordering information. This product is suitable for the use of recycled paper according to DIN 19309.

## Material restrictions

This product does not contain added mercury.

This product does not contain batteries.

This HP product contains lead in solder.

For recycling information, you can contact <http://www.hp.com/go/recycle> or contact your local authorities or the Electronics Industry Alliance: <http://www.eiae.org>.

## Material safety data sheet

Material Safety Data Sheets (MSDS) can be obtained from the HP LaserJet Supplies website at <http://www.hp.com/go/msds>.

## Extended warranty

HP SupportPack provides coverage for the HP hardware product and all HP supplied internal components. The hardware maintenance covers a three-year period from the date of the HP product purchase. The customer must purchase HP SupportPack within 180 days of the HP product purchase. For more information, contact HP Customer Care. See the support flyer that shipped in the box with the printer.

## Spare parts and supplies availability

Spare parts and consumable supplies for this product will be available for at least five years after production has stopped.

## For more information

On HP's environmental programs, including:

- Product environmental profile sheet for this and many related HP products
- HP's commitment to the environment
- HP's environmental management system
- HP's end-of-life product return and recycling program
- Material Safety Data Sheets

See: <http://www.hp.com/go/environment> or <http://www.hp.com/hpinfo/community/environment>



## FCC regulations

This equipment has been tested and found to comply with the limits for a Class B digital device, pursuant to Part 15 of the FCC rules. These limits are designed to provide reasonable protection against harmful interference in a residential installation. This equipment generates, uses, and can radiate radio frequency energy. If this equipment is not installed and used in accordance with the instructions, it may cause harmful interference to radio communications. However, there is no guarantee that interference will not occur in a particular installation; the presence of interference can be determined by turning the equipment off and on. If this equipment does cause harmful interference to radio or television communications, the user is encouraged to try to correct the interference by one or more of the following measures:

- Reorient or relocate the receiving antenna.
- Increase distance between equipment and receiver.
- Connect equipment to an outlet on a circuit different from that to which the receiver is located.
- Consult your dealer or an experienced radio/television technician.

---

### Note

Any changes or modifications to the printer that are not expressly approved by HP could void the user's authority to operate this equipment.

Use of a shielded interface cable is required to comply with the Class B limits of Part 15 of FCC rules.

---

## Declaration of Conformity

according to ISO/IEC Guide 22 and EN 45014

**Manufacturer's Name:** Hewlett-Packard Company  
**Manufacturer's Address:** 11311 Chinden Boulevard  
Boise, Idaho 83714-1021, USA

**declares, that the product**

**Product Name:** HP Color LaserJet 2500L, 2500, 2500n, 2500tn  
Including: 250-sheet and 500-sheet paper feeder unit

**Model Number:** C9705A, C9706A, C9707A, C9708A  
Including: C9698A, C9699A

**Product Options:** ALL

**conforms to the following Product Specifications:**

**Safety:** IEC 60950:1991+A1+A2+A3+A4 / EN 60950:1992+A1+A2+A3+A4+A11  
IEC 60825-1:1993+A1 / EN 60825-1:1994+A11 (Class 1 Laser/LED Product)  
GB4943-1995

**EMC:** CISPR 22:1993+A1+A2 / EN 55022:1994+A1+A2 Class B<sup>1</sup>  
EN 61000-3-2:1995 / A14  
EN 61000-3-3:1995  
EN 55024:1998  
FCC Title 47 CFR, Part 15 Class B<sup>2</sup> / ICES-003, Issue 3/ GB9254-1998  
AS / NZS 3548:1995+A1+A2

**Supplementary Information:**

The product herewith complies with the requirements of the EMC Directive 89/336/EEC and the Low Voltage Directive 73/23/EEC, and carries the CE-marking accordingly.

- 1) The product was tested in a typical configuration with Hewlett-Packard Personal Computer Systems.
- 2) This Device complies with Part 15 of the FCC Rules. Operation is subject to the following two conditions: (1) this device may not cause harmful interference, and (2) this device must accept any interference received, including interference that may cause undesired operation.  
  
\* This product includes LAN (Local Area Network) options. When the interface cable is attached to LAN connectors, the product meets the requirements of EN55022 Class A in which case the following applies: "Warning — This is a class A product. In a domestic environment this product may cause radio interference in which case the user may be required to take adequate measures."
- 3) The model number may include an additional suffix letter "R".

**Boise, Idaho USA  
6 June, 2002**

**For regulatory topics only:**

**Australia Contact:** Product Regulations Manager, Hewlett-Packard Australia Ltd., 31-41 Joseph Street, Blackburn, Victoria 3130, Australia

**European Contact:** Your Local Hewlett-Packard Sales and Service Office or Hewlett-Packard GmbH, Department HQ-TRE / Standards Europe, Herrenberger Straße 130, D-71034 Böblingen (FAX: +49-7031-14-3143)

**USA Contact:** Product Regulations Manager, Hewlett-Packard Company, PO Box 15, Mail Stop 160, Boise, ID 83707-0015 (Phone: 208-396-6000)

## Laser safety statement

The Center for Devices and Radiological Health (CDRH) of the U.S. Food and Drug Administration has implemented regulations for laser products manufactured since August 1, 1976. Compliance is mandatory for products marketed in the United States. The printer is certified as a “Class 1” laser product under the U.S. Department of Health and Human Services (DHHS) Radiation Performance Standard according to the Radiation Control for Health and Safety Act of 1968.

Since radiation emitted inside the printer is completely confined within protective housings and external covers, the laser beam cannot escape during any phase of normal user operation.

### WARNING!

Using controls, making adjustments, or performing procedures other than those specified in this user guide may result in exposure to hazardous radiation.

## Canadian DOC statement

Complies with Canadian EMC Class B requirements.

«Conforme à la classe B des normes canadiennes de compatibilité électromagnétiques (CEM).»

## VCCI statement (Japan)

この装置は、情報処理装置等電波障害自主規制協議会（VCCI）の基準に基づくクラスB情報技術装置です。この装置は、家庭環境で使用することを目的としていますが、この装置がラジオやテレビジョン受信機に近接して使用されると、受信障害を引き起こすことがあります。  
取り扱い説明書に従って正しい取り扱いをして下さい。

## Korean EMI statement

사용자 안내문 (B 급 기기)

이 기기는 비업무용으로 전자파장해검정을 받은 기기로서, 주거지역에서는 물론 모든 지역에서 사용할 수 있습니다.

# Finnish laser statement

## LASERTURVALLISUUS

### LUOKAN 1 LASERLAITE

#### KLASS 1 LASER APPARAT

HP Color LaserJet 2500 -laserkirjoitin on käyttäjän kannalta turvallinen luokan 1 laserlaite. Normaalisessa käytössä kirjoittimen suojakotelo estää lasersäteiden pääsyn laitteen ulkopuolelle.

Laitteen turvallisuusluokka on määritetty standardin EN 60825-1 (1993) mukaisesti.

#### **VAROITUS!**

Laitteen käyttäminen muulla kuin käyttöohjeessa mainitulla tavalla saattaa altistaa käyttäjän turvallisuusluokan 1 ylittävälle näkymättömälle lasersäteilylle.

#### **WARNING!**

Om apparaten används på annat sätt än i bruksanvisning specificerats, kan användaren utsättas för osynlig laserstrålning, som överskrider gränsen för laserklass 1.

#### **HUOLTO**

HP Color LaserJet 2500 -kirjoittimen sisällä ei ole käyttäjän huollettavissa olevia kohteita. Laitteen saa avata ja huoltaa ainoastaan sen huoltamiseen koulutettu henkilö. Tällaiseksi huoltotoimenpiteeksi ei katsota väriainekasetin vaihtamista, paperiradan puhdistusta tai muita käyttäjän käsikirjassa lueteltuja, käyttäjän tehtäväksi tarkoitettuja ylläpitotoimia, jotka voidaan suorittaa ilman erikoistyökaluja.

#### **VARO!**

Mikäli kirjoittimen suojakotelo avataan, olet alttiina näkymättömälle lasersäteilylle laitteen ollessa toiminnassa. Älä katso säteeseen.

#### **WARNING!**

Om laserprinterns skyddshölje öppnas då apparaten är i funktion, utsättas användaren för osynlig laserstrålning. Betrakta ej strålen.

Tiedot laitteessa käytettävän laserdiodin säteilyominaisuuksista:

Aallonpituus 770-795 nm

Teho 5 mW

Luokan 3B laser

# C

# Print media specifications

## Introduction

This section contains specifications for the paper and other print media you can use with the printer. The following topics appear in this section of the user guide:

[“General guidelines” on page 124](#)

[“Tray specifications” on page 125](#)

[“Paper and print media” on page 127](#)

[“Envelopes” on page 130](#)

[“Labels” on page 132](#)

[“Grayscale transparencies” on page 132](#)

## General guidelines

This printer accepts a variety of media, such as cut-sheet paper (including up to 100% recycled fiber content paper), envelopes, labels, grayscale transparencies, and custom-size paper. Properties such as weight, composition, grain, and moisture content are important factors affecting printer performance and output quality. Paper that does not meet the guidelines outlined in this manual can cause the following problems:

- Poor print quality
- Increased jams
- Premature wear on the printer, requiring repair

Some paper might meet all of the guidelines in this manual and still not produce satisfactory results. This problem might be the result of improper handling, unacceptable temperature and humidity levels, or other variables over which Hewlett-Packard has no control.

Before purchasing large quantities of paper, always test a sample and make sure the paper meets the requirements specified in this user guide and in the *HP LaserJet Printer Family Print Media Guide*. For ordering information, see [“Supplementary Documentation” on page 25](#).

---

### CAUTION

---

Using paper that does not meet HP specifications can cause problems for the printer, requiring repair. This repair is not covered by the Hewlett-Packard warranty or service agreements.

## Tray specifications

This section contains information about the sizes, weights, and capacities of paper and other print media that each tray supports.

### Tray 1 specifications

Tray 1	Dimensions <sup>1</sup>	Weight	Capacity <sup>2</sup>
Paper	Minimum: 76 by 127 mm (3 by 5 in.)	60 to 177 g/m <sup>2</sup> (16 to 47 lb)	125 sheets of 75 g/m <sup>2</sup> (20 lb) paper
	Maximum: 216 by 356 mm (8.5 by 14 in.)		
Grayscale transparencies and opaque film	Same as minimum and maximum sizes listed above.	Thickness: 0.10 to 0.13 mm (0.0039 to 0.0051 in.)	50 typically
Labels <sup>3</sup>		Thickness: up to 0.23 mm (up to 0.0091 in.)	50 typically
Envelopes		Up to 90 g/m <sup>2</sup> (16 to 24 lb)	up to 10

1. The printer supports a wide range of standard and custom sizes of print media. Check the printer driver for supported sizes.
2. Capacity can vary depending on media weight and thickness, and environmental conditions.
3. Smoothness - 100 to 250 (Sheffield).

## Optional tray 2 specifications

Optional tray 2 (250-sheet tray)	Dimensions <sup>1</sup>	Weight	Capacity <sup>2</sup>
Letter	216 by 279 mm (8.5 by 11 in.)	60 to 105 g/m <sup>2</sup> (16 to 28 lb)	250 sheets of 75 g/m <sup>2</sup> (20 lb) paper
A4	210 by 297 mm (8.3 by 11.7 in.)		
A5	148 by 210 mm (5.8 by 8.3 in.)		
B5 (ISO)	176 by 250 mm (6.9 by 9.9 in.)		
B5 (JIS)	182 by 257 mm (7.2 by 10 in.)		
Executive	191 by 267 mm (7.3 by 10.5 in.)		
Legal	216 by 356 mm (8.5 by 14 in.)		
8.5 x 13 in.	216 by 330 mm (8.5 by 13 in.)		

1. The printer supports a wide range of standard and custom sizes of print media. Check the printer driver for supported sizes.
2. Capacity can vary depending on media weight and thickness, and environmental conditions.

## Optional tray 3 specifications

Optional tray 3 (500-sheet tray)	Dimensions <sup>1</sup>	Weight	Capacity <sup>2</sup>
Letter	216 by 279 mm (8.5 by 11 in.)	60 to 105 g/m <sup>2</sup> (16 to 28 lb)	500 sheets of 75 g/m <sup>2</sup> (20 lb) paper
A4	210 by 297 mm (8.3 by 11.7 in.)		

1. The printer supports a wide range of standard and custom sizes of print media. Check the printer driver for supported sizes.
2. Capacity can vary depending on media weight and thickness, and environmental conditions.



## Paper and print media

This section contains information about specifications for quality of paper, guidelines for paper usage, and guidelines for paper storage.

### Specifications for quality

Category	Specifications
Acid Content	5.5 pH to 8.0 pH
Caliper	0.094 to 0.18 mm (3.0 to 7.0 mils)
Curl in Ream	Flat within 5 mm (.02 in.)
Cut Edge Conditions	Cut with sharp blades with no visible fray
Fusing Compatibility	Must not scorch, melt, offset, or release hazardous emissions when heated to 195° C (383° F) for 0.1 second
Grain	Long Grain
Moisture Content	4% to 6% by weight
Smoothness	100 to 250 Sheffield

For complete paper specifications for all HP LaserJet printers, see the *HP LaserJet Printer Family Print Media Guide*. To order the guide, see [“Supplementary Documentation”](#) on page 25.

## Guidelines for usage

For best results, make sure the paper is of good quality, and free of cuts, nicks, tears, spots, loose particles, dust, wrinkles, voids, and curled or bent edges.

For best quality color printing, use a smooth type of paper. Generally, the smoother the paper, the better the results, although coated, photo, and glossy papers are not supported.

If you are unsure what type of paper you are loading (such as bond or recycled), check the label on the package of paper.

The following problems with paper cause print quality deviations, jamming, or even damage to the printer.

Symptom	Problem with paper	Solution
Poor print quality or toner adhesion; problems with feeding	The paper is too moist, too rough, too heavy or too smooth, or it is embossed or from a faulty paper lot.	Try another kind of paper, between 100 and 250 Sheffield, 4 to 6 percent moisture content.
Dropouts, jamming, curl	The paper has been stored improperly.	Store paper flat in its moisture-proof wrapping.
	The paper has variability from one side to the other.	Turn the paper over.
Excessive curl; problems with feeding	The paper is too moist, has the wrong grain direction, or is of short-grain construction	Open the rear output bin, or use long-grain paper.
	The paper varies from side-to-side.	Turn the paper over.
Jamming, damage to printer	The paper has cutouts or perforations.	Use paper that is free of cutouts or perforations.
Problems with feeding	The paper has ragged edges.	Use high-quality paper made for laser printers.
	Paper has variability from one side to the other.	Turn the paper over.

- Do not use letterhead paper that is printed with low-temperature inks, such as those used in some types of thermography.
- Do not use raised or embossed letterhead.
- The printer uses heat and pressure to fuse toner to the paper. Make sure that any colored paper or preprinted forms use inks that are compatible with this fusing temperature (195° C or 383° F for 0.1 second).

### CAUTION

Failure to follow the guidelines listed above could cause jams or damage to the printer.

## Printing and storage environment

Ideally, the printing and paper-storage environment should be at or near room temperature, and not too dry or too humid. Remember that paper is hygroscopic; it absorbs and loses moisture rapidly.

Heat works with humidity to damage paper. Heat causes the moisture in paper to evaporate, while cold causes it to condense on the sheets. Heating systems and air conditioners remove most of the humidity from a room. As paper is opened and used, it loses moisture, causing streaks and smudging. Humid weather or water coolers can cause the humidity to increase in a room. As paper is opened and used it absorbs any excess moisture, causing light print and dropouts. Also, as paper loses and gains moisture it can distort. This issue can cause jams.

As a result, paper storage and handling are as important as the paper-making process itself. Paper storage environmental conditions directly affect the feed operation.

Care should be taken not to purchase more paper than can be easily used in a short time (about three months). Paper stored for long periods can experience heat and moisture extremes, which can cause damage. Planning is important to prevent damage to a large supply of paper.

Unopened paper in sealed reams can remain stable for several months before use. Opened packages of paper have more potential for environmental damage, especially if they are not wrapped with a moisture-proof barrier.

The paper-storage environment should be properly maintained to ensure optimum printer performance. The required condition is 20° to 24° C (68° to 75° F), with a relative humidity of 45 percent to 55 percent. The following guidelines should be helpful when evaluating the paper's storage environment:

- Paper should be stored at or near room temperature.
- The air should not be too dry or too humid (due to the hygroscopic properties of paper).
- The best way to store an opened ream of paper is to rewrap it tightly in its moisture-proof wrapping. If the printer environment is subject to extremes, unwrap only the amount of paper to be used during the day's operation to prevent unwanted moisture changes.
- Avoid storing paper and print media near heating and air conditioning vents or near windows and doors that are frequently open.

# Envelopes

Use only tray 1 to print envelopes. Select the type of envelope you are using from the **Print** dialog box or the printer driver. For UNIX, Linux, and OS/2, this feature is available in the embedded Web server if the printer is connected to the network.

In your program, set the margins for the envelope. The following table gives typical address margins for a commercial #10 or DL envelope.

Type of address	Top margin	Left margin
Return address	15 mm (0.6 in.)	15 mm (0.6 in.)
Delivery address	51 mm (2 in.)	89 mm (3.5 in.)

- For the best print quality, position margins no closer than 15 mm (0.6 in.) from the edges of the envelope.
- Avoid printing over the area where the envelope seams meet.

## Envelope storage

Proper storage of envelopes helps contribute to print quality. Envelopes should be stored flat. If air is trapped in an envelope creating an air bubble, then the envelope might wrinkle during printing.

For more information, see [“Printing on envelopes” on page 43](#).

## Envelope construction

Envelope construction is critical. Envelope fold lines can vary considerably, not only between manufacturers, but also within a box from the same manufacturer. Successful printing on envelopes depends upon the quality of the envelopes. When selecting envelopes, consider the following components:

- **Weight:** The weight of the envelope paper should not exceed 105 g/m<sup>2</sup> (24 lb) or jamming might occur.
- **Construction:** Prior to printing, envelopes should lie flat with less than 6 mm (0.25 in.) curl, and should not contain air.
- **Condition:** Envelopes should not be wrinkled, nicked, or otherwise damaged.
- **Temperature:** You should use envelopes that are compatible with the heat and pressure of the printer.
- **Size:** You should use only envelopes within the following size ranges.

Tray	Minimum	Maximum
Tray 1	76 by 127 mm (3 by 5 in.)	216 by 356 mm (8.5 by 14 in.)

## Envelopes with double side-seams

Double side-seam construction has vertical seams at both ends of the envelope rather than diagonal seams. This style might be more likely to wrinkle. Be sure the seam extends all the way to the corner of the envelope as illustrated below.

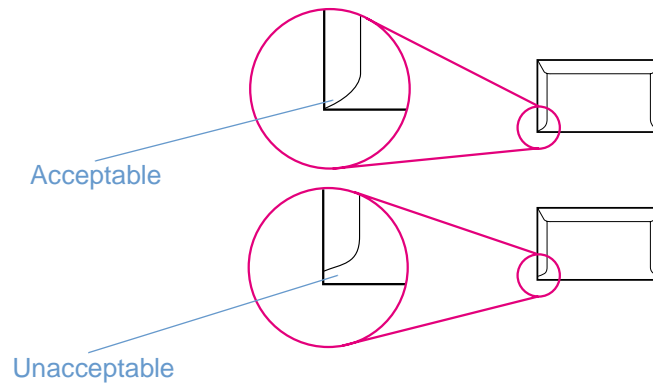

## Envelopes with adhesive strips or flaps

Envelopes with a peel-off adhesive strip or with more than one flap that folds over to seal must use adhesives compatible with the heat and pressure in the printer. The extra flaps and strips might cause wrinkling, creasing, or even jams and might even damage the fuser.

## Labels

Select the type of label you are using from the **Print** dialog box or the printer driver. For UNIX, Linux, and OS/2, this feature is available in the embedded Web server if the printer is connected to the network.

---

### CAUTION

To avoid damaging the printer, use only labels recommended for laser printers. To prevent serious jams, always use tray 1 to print labels and always use the straight-through paper path. Never print on the same sheet of labels more than once or print on a partial sheet of labels.

When selecting labels, consider the quality of each component:

- **Adhesives:** The adhesive material should be stable at 195° C (383° F), which is the printer fusing temperature.
- **Arrangement:** Only use labels with no exposed backing between them. Labels can peel off sheets with spaces between the labels, causing serious jams.
- **Curl:** Prior to printing, labels must lie flat with no more than 13 mm (.5 in.) of curl in any direction.
- **Condition:** Do not use labels with wrinkles, bubbles, or other indications of separation.

For more information, see [“Printing on labels” on page 44](#).

## Grayscale transparencies

Select **Grayscale Transparencies** from the **Print** dialog box or the printer driver. For UNIX, Linux, and OS/2, this feature is available in the embedded Web server if the printer is connected to the network.

The printer supports printing *in grayscale* on grayscale or color transparencies. (Grayscale transparencies are usually less expensive.) Only use transparencies recommended for use in laser printers.

Grayscale transparencies used in the printer must be able to withstand 195° C (383° F), which is the printer fusing temperature. Grayscale transparencies print only in grayscale (black and white).

---

### CAUTION

To avoid damage to the printer, use only grayscale transparencies recommended for use in laser printers. See [“Accessories and ordering information” on page 24](#).

For more information, see [“Printing on grayscale transparencies” on page 45](#).

# D Working with memory and print server cards

## Introduction

This section provides information about the following topics:



- [“Printer memory” on page 134](#)
- [“Installing memory and font DIMMs” on page 135](#)
- [“Checking DIMM installation” on page 137](#)
- [“Enabling memory” on page 138](#)
- [“Enabling the language font DIMM” on page 138](#)
- [“Installing an HP Jetdirect print server card” on page 139](#)

## Printer memory

The printer has two dual inline memory module (DIMM) slots for upgrading with:

- More printer memory. DIMMs are available in 32, 64, and 128 MB for a maximum of 256 MB.
- DIMM-based accessory fonts, macros, and patterns.

You might want to add more memory to the printer if you often print complex graphics or PS documents, or use many downloaded fonts. Additional memory also allows the printer to print multiple, collated copies at the maximum speed.

Before ordering additional memory, see how much is currently installed by printing a Configuration page. [Press  (GO) and  (CANCEL JOB) simultaneously, or use the embedded Web server.] To order DIMMs, see [“Accessories and ordering information” on page 24](#). Single inline memory modules (SIMMs) used on previous HP LaserJet printers are not compatible with the printer.



## Installing memory and font DIMMs

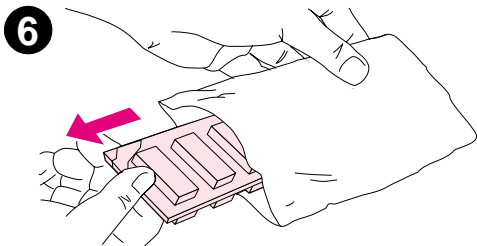
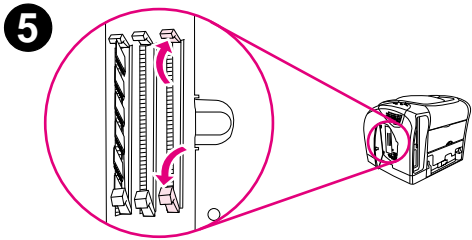
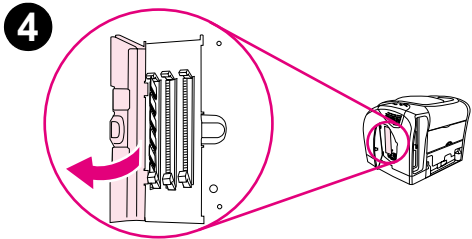
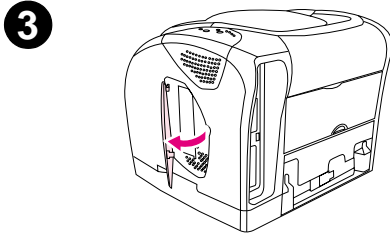
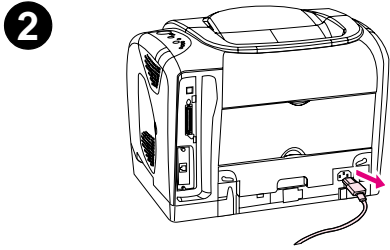

You can install more memory for the printer, and you can also install a font DIMM to allow the printer to print characters for languages such as Chinese or the Cyrillic alphabet.



---

### CAUTION

Static electricity can damage DIMMs. When handling DIMMs, either wear an antistatic wrist strap, or frequently touch the surface of the DIMM antistatic package and then touch bare metal on the printer.

---

### To install memory and font DIMMs

- 1 Print a Configuration page by pressing  (Go) and  (CANCEL JOB) simultaneously. (A Supplies Status page and possibly an HP Jetdirect Configuration page also print.) If the Configuration page does not print in your language, see “Special pages” on page 56.
- 2 After the Configuration page prints, turn the printer off and disconnect the power cable.
- 3 On the right side of the printer, open the DIMM door.
- 4 Open the second DIMM door.
- 5 Release the locks on each side of the DIMM slot.
- 6 Remove the DIMM from the antistatic package.

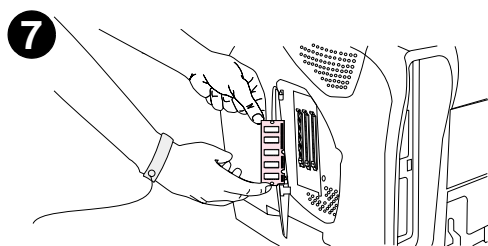

7 Holding the DIMM by the edges as shown in the illustration, align the notches on the DIMM with the DIMM slot.

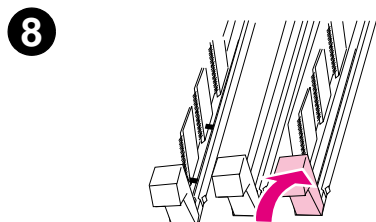

8 Firmly press the DIMM straight into the slot. Firmly close the locks on each side of the DIMM until they snap into place.

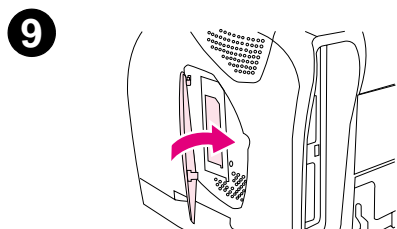

9 Close the two DIMM doors.

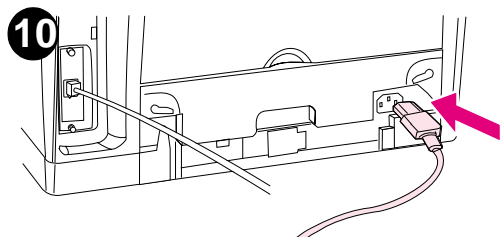



10 Reconnect the power cable and turn the printer on.

11 Go to [“Checking DIMM installation”](#) on page 137.

# Checking DIMM installation

Check that the DIMMs are installed correctly and working.

## To check DIMM installation

- 1 Turn the printer on. Check that the Ready light is on after the printer has gone through the startup sequence. If an error message appears, a DIMM might have been incorrectly installed.
- 2 Print a Configuration page by pressing  (Go) and  (CANCEL JOB) simultaneously. (A Supplies Status page and possibly an HP Jetdirect Configuration page also print.)
- 3 Check the Installed Personalities and Options section on the Configuration page and compare it with the Configuration page printed before the DIMM installation.
- 4 If the amount of recognized memory has not increased or the font DIMM is not recognized:
  - The DIMM might not be installed correctly. Repeat the installation procedure.
  - The DIMM might be defective. Try installing a different DIMM.
- 5 Once you have installed the DIMM correctly, go to [“Enabling memory” on page 138](#) if you installed a memory DIMM or [“Enabling the language font DIMM” on page 138](#) if you installed a language font DIMM.

## Enabling memory

If the printer has a new memory DIMM installed, all Windows users of the printer must set the printer driver to recognize the newly added memory. Macintosh computers automatically recognize new memory.

### To enable memory for Windows

- 1 On the **Start** menu, point to **Settings**, and click **Printers** or **Printers and Faxes**.
- 2 Select this printer and select **Properties**.
- 3 On the **Configure** tab, click **More**.
- 4 In the **Total Memory** field, enter the total amount of memory that is now installed.
- 5 Click **OK**.

### To enable memory for Mac OS

---

#### Note

Enabling memory for OS X might be different than how it is stated here.

- 1 Click the desktop printer icon.
- 2 From the **Printing** menu, select **Change Setup**.

## Enabling the language font DIMM

If the printer has a new language font DIMM installed, all Windows users of the printer must set the printer driver to recognize the newly installed font DIMM. Macintosh computers automatically recognize new language font DIMMs.

### To enable fonts for Windows

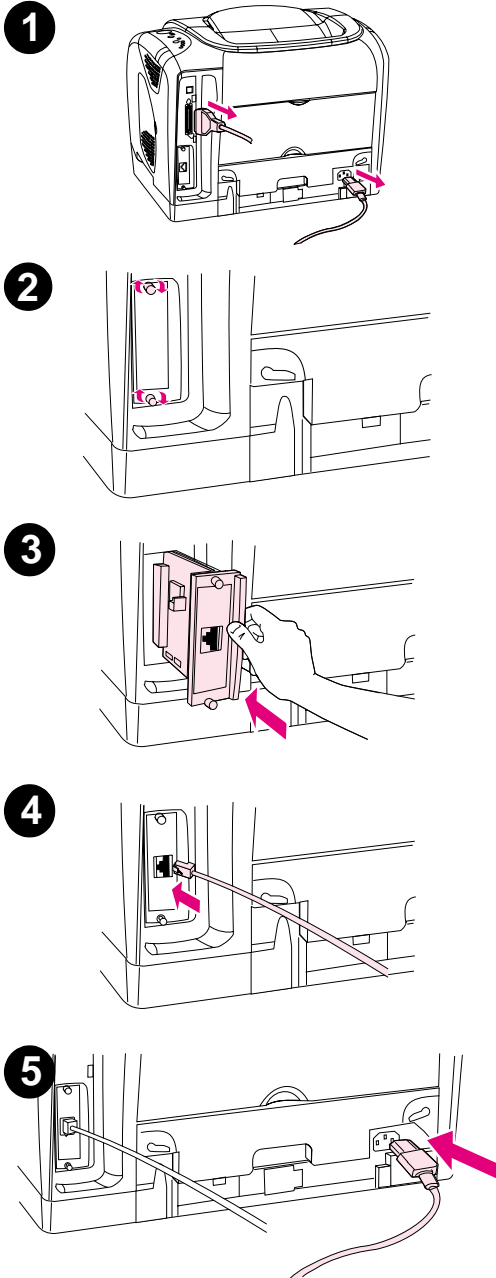

- 1 On the **Start** menu, point to **Settings**, and click **Printers**.
- 2 Select this printer and select **Properties**.
- 3 On the **Configure** tab, click **More**.
- 4 Select the **Font DIMM** check box.
- 5 Click **OK**.

# Installing an HP Jetdirect print server card



You can install an optional HP Jetdirect print server card in the 2500L or 2500 model printer, which comes with an EIO slot.

## To install an HP Jetdirect print server card

- 1 Turn the printer off and disconnect the power cable and the parallel or USB (interface) cable.
- 2 Locate the EIO slot. Loosen and remove the two retaining screws holding the cover for the EIO slot onto the printer, and then remove the cover.
- 3 Firmly insert the HP Jetdirect print server card into the EIO slot. Insert and tighten the retaining screws that came with the print server card.
- 4 Connect the network cable.
- 5 Reconnect the power cable, and turn the printer on.
- 6 Print a Configuration page at the printer by pressing  (Go) and  (CANCEL JOB) simultaneously. In addition to a printer Configuration page and a Supplies Status page, an HP Jetdirect configuration page should print. If it does not print, uninstall and reinstall the print server card to ensure that it is completely seated in the slot.

---

### Note

If the configuration page does not print in your language, see [“Special pages” on page 56](#).

---

- 7 Perform *one* of these steps:
  - Choose the correct port. See the computer or operating system documentation for instructions.
  - Reinstall the software, choosing the network installation this time.



# Index

## Numerics

- 250-sheet tray. *See* tray 2
- 4-Color option 52
- 500-sheet tray. *See* tray 3

## A

- accessories
  - errors 76, 79
  - ordering 3
  - part numbers 24
- acoustic emissions 115
- Adaptive Halftoning options 52
- adding paper 31
- adhesive labels
  - output path 42
  - printing 44
  - specifications 125, 132
- agreements, maintenance 108, 118
- alerts
  - e-mail 61
  - HP Printer Status and Alerts 17, 63
- Apple LaserWriter 8 driver 20
- Apple Macintosh. *See* Macintosh
- AppleTalk, troubleshooting 97
- applications, settings 21
- Attention light 16, 75
  - See also* lights
- Automatic color adjustment 51

## B

- background, gray 83
- bands, troubleshooting 82
- battery specifications 117
- bins, output
  - features 11
  - jams, clearing 69
  - locating 13
  - selecting 42
  - troubleshooting curl 94
- black and white printing
  - selecting 39
  - troubleshooting 87
- Black cartridge
  - See also* cartridges
  - empty or missing, light messages 73
  - life expectancy 101
  - low 72
  - non-HP 74
  - part number 24
  - status light 15, 72
- Black Only option 52
- blank pages, troubleshooting 94
- blinking lights
  - accessory error messages 79
  - consumables status messages 72
  - printer status messages 75
  - printer status secondary messages 77
- both sides, printing on 48
- browser requirements 58
- buffer overflow errors 78
- buttons, control panel 15

## C

- cables
  - connecting 14
  - errors 77
  - ordering 3
  - part numbers 24
  - troubleshooting 93
- calibrating printer 100
- Cancel Job button 16, 49
- capacity
  - output bins 42
  - tray 1 125
  - tray 2 126
  - tray 3 126
- cardstock
  - printing on 42, 46
  - specifications 125
- cartridges
  - empty or missing, light messages 73
  - HP fraud hotline 103
  - life expectancy 101
  - low 72
  - non-HP 74
  - ordering 3
  - part numbers 24
  - recycling 117
  - replacing 102
  - status lights 15, 72
  - status page, printing 57
  - status, viewing with embedded Web server 61
  - storage specifications 115
- CDs
  - software, ordering 25
  - Support Assistant 3
- characters, troubleshooting 84
- Chooser, Macintosh 97
- cleaning page, printing 59
- clearing jams
  - common locations 66
  - input areas 68
  - inside printer 67
  - output areas 69
- CMYK printing 53
- color
  - Automatic adjustment 51
  - calibration 100
  - features 50
  - four-color (CMYK) printing 53
  - grayscale, printing as 39
  - HP ColorSmart 51
  - HP ImageREt 2400 50
  - Manual adjustment options 52
  - matching 53
  - settings, changing 51
  - sRGB 53
  - troubleshooting 87
- Configuration page
  - printing 56
  - viewing with embedded Web server 61
- configurations, printer 10
- connecting cables 14

- consumables
  - availability 118
  - life expectancies 101
  - ordering 3
  - part numbers 24
  - recycling 117
  - specifications 114
  - status lights 15, 72
  - status page, printing 57
  - status, viewing with embedded Web server 61
- continuable attention errors 76, 77
- contracts, maintenance 108, 118
- control panel
  - accessory error lights 79
  - consumables status 72
  - lights and buttons, description 15
  - lights and messages, troubleshooting 71
  - printer status lights 75
  - secondary printer status lights 77
  - viewing with embedded Web server 60
- Courier font 96
- covers, document
  - cardstock, printing on 42, 46
  - paper specifications 125
  - using different paper for 41
- covers, printer 13
- creases, troubleshooting 85
- crooked pages 85
- curl, troubleshooting 84, 94
- custom paper sizes 39, 46
- customer support
  - HP Express Exchange 109
  - maintenance agreements 108, 118
  - repacking printer 110
  - service information form 111
  - telephone and online 3

- Cyan cartridge
  - See also* cartridges
  - empty or missing, light messages 73
  - life expectancy 101
  - low 72
  - non-HP 74
  - part number 24
  - status light 15, 72

## D

- declaration of conformity 120
- default settings, restoring 41
- deleting print jobs 49
- Demo page, printing 56
- Detail halftone option 52
- Device tab, Toolbox 58
- diagnostics pages 59
- different first page 41
- digital cameras, color matching 53
- dimensions, media. *See* sizes, media
- dimensions, printer 114
- DIMMs
  - adding 134
  - enabling 138
  - font, settings 94
  - installing 135
  - part numbers 24
  - slot errors 79
  - verifying installation 137
- documentation 25, 58
- Documentation tab, Toolbox 58
- dots per inch (dpi)
  - HP ImageREt 2400 50
  - settings 41

- specifications 11
- troubleshooting print quality 80
- dots, troubleshooting 82
- double-sided printing 48
- downloading drivers 21
- dpi (dots per inch)
  - HP ImageREt 2400 50
  - settings 41
  - specifications 11
  - troubleshooting print quality 80
- drivers
  - downloading 21
  - features 38
  - Macintosh 20
  - opening 34
  - operating systems supported 17
  - restoring default settings 41
  - settings, changing 37
  - uninstalling 22
  - Windows, features 18
- dropouts, troubleshooting 82
- drum, imaging
  - empty, light messages 73
  - life expectancy 101
  - low 72
  - non-HP 74
  - ordering 3
  - part number 24
  - status light 15
- duplexing 48

## E

- Edge Control 52
- EIO port errors 79
- electrical specifications 114
- e-mail alerts 61
- embedded Web server
  - operating systems supported 17
  - toner level, checking from 102
  - using 60
  - viewing with HP Printer Status and Alerts 63
- energy consumption 114, 116
- engine errors 77
- engine, cleaning 99
- enlarging documents 40
- envelopes
  - output path 42
  - printing 43
  - specifications 125, 130
- environmental
  - features 116
  - paper specifications 129
  - printer specifications 115
- EPS files, troubleshooting 97
- error messages
  - accessory 79
  - consumables status lights 72
  - HP Printer Status and Alerts 63
  - Macintosh 89
  - printer status 75
  - secondary, printer status 77
  - viewing with embedded Web server 60
  - Windows 89
- event log, viewing 61
- expansion, memory 134
- Explorer, versions supported 58
- Express Exchange, HP 109
- extended warranty 108, 118



## F

- face down bin. *See* top output bin
- face up bin. *See* rear output door
- faded print 82
- FCC statements 119
- features
  - color 50
  - drivers 38
  - printer 10
- film, transparency. *See* transparencies
- first page, different 41
- Fit to Page option 40
- font DIMMs
  - See also* DIMMs
  - enabling 138
  - installing 135
  - part numbers 24
  - settings 94
- fonts
  - included 11
  - troubleshooting 96, 97
- 4-Color option 52
- four-color printing 53
- fraud hotline 103
- fuser, ordering 25

## G

- general continuable errors 78
- getting started guide 25
- Go light and button 16
- gray background, troubleshooting 83
- grayscale printing
  - selecting 39
  - transparencies 45
  - troubleshooting 87

## H

- halftone options 52
- heavy paper
  - printing on 42, 46
  - specifications 125
- Help
  - See also* customer support
  - printer drivers 37
- HP Color LaserJet 2500 Toolbox
  - calibrating printer 100
  - operating systems supported 17
  - using 58
- HP ColorSmart 51
- HP Customer Care 3
- HP Express Exchange 109
- HP fraud hotline 103
- HP ImageREt 2400 50
- HP Jetdirect print servers
  - configuring 62
  - EIO port errors 79
  - HP Printer Status and Alerts 17, 63
  - information page, printing 56
  - installing 139
  - models including 12
  - ordering 3
  - part numbers 24
  - troubleshooting 91
- HP LaserJet paper 25
- HP multipurpose paper 25
- HP Printer Status and Alerts
  - operating systems supported 17
  - toner level, checking from 102
  - using 63
- HP Printing Supplies Returns and Recycling Program 117

- HP Support Assistant CD 3
- HP SupportPack 108, 118
- HP Web Jetadmin
  - operating systems supported 17
  - toner level, checking from 102
  - using 19
- humidity specifications
  - paper, storing 129
  - printer environment 115

## I

- I/O errors 77
- IBM OS/2 support 17
- image quality
  - HP ImageREt 2400 50
  - settings 41
  - specifications 11
  - troubleshooting 80
- ImageREt 2400 50
- imaging drum
  - empty, light messages 73
  - life expectancy 101
  - low 72
  - non-HP 74
  - ordering 3
  - part number 24
  - status light 15
- information pages, printing 56
- ink cartridges. *See* print cartridges
- input trays
  - configuring 60
  - default 28
  - features 11
  - included 10
  - jams, clearing 68
  - loading 31
  - locating 13
  - media supported 29, 125
  - ordering 3
  - part numbers 24, 25
  - selecting 34, 38
  - troubleshooting 92
- install notes 58
- installing
  - HP Jetdirect print servers 139
  - memory 134
- interface ports
  - cables, ordering 24
  - connecting to 14
  - locating 13
  - troubleshooting 93, 98
  - types included 11
- Internet Explorer, versions supported 58

## J

- jams
  - causes of 66
  - input areas 68
  - inside printer 67
  - output areas 69
- Jetadmin
  - operating systems supported 17
  - toner level, checking from 102
  - using 19
- Jetdirect print servers
  - configuring 62
  - EIO port errors 79
  - HP Printer Status and Alerts 17, 63
  - information page, printing 56
  - installing 139

- models including 12
- ordering 3
- part numbers 24
- troubleshooting 91

**K**

- keys, control panel 15

**L**

- labels
  - output path 42
  - printing 44
  - specifications 125, 132
- language
  - documentation 25
  - embedded Web server 61
  - information pages 56
- languages, printer
  - errors 78
  - features 11
- laser safety statements 121
- LaserJet 2500 Toolbox
  - calibrating printer 100
  - operating systems supported 17
  - using 58
- LaserJet paper 25
- LaserWriter 8 driver 20
- letterhead
  - output path 42
  - printing 47
  - specifications 128
- life expectancies, supplies 101
- light print, troubleshooting 82
- lights
  - accessory error messages 79
  - consumables status messages 72
  - locating 15
  - printer status messages 75
  - printer status secondary messages 77
  - states 71
- Limit Check error 89
- lines, troubleshooting 82
- LINUX support 17
- loading media
  - tray 1 31
  - tray 2 32
  - tray 3 33
- loose toner, troubleshooting 83

**M**

- Macintosh
  - driver features 38
  - features supported 17
  - printing from 36
  - problems, troubleshooting 97
  - settings 37
  - software features 20
  - uninstalling software 23
- Magenta cartridge
  - See also* cartridges
  - empty or missing, light messages 73
  - life expectancy 101
  - low 72
  - non-HP 74
  - part number 24
  - status light 15, 72
- mailing labels
  - output path 42
  - printing 44
  - specifications 125, 132

- maintenance
  - agreements 108, 118
  - cleaning printer 59
  - replacing print cartridges 101
- Manual color options 52
- manual duplexing 48
- Manual Feed mode 93
- manuals 25, 58
- margins, envelopes 130
- matching, color 53
- Material Safety Data Sheet 118
- media
  - cardstock 46
  - custom-sized 39, 46
  - envelopes 43, 130
  - first page, different 41
  - HP, ordering 25
  - jams 66
  - labels 44, 132
  - letterhead 47
  - loading trays 31
  - long 31
  - output options 42
  - selecting 30, 124
  - sizes and types supported 29
  - specifications 127
  - transparencies 45, 132
  - tray 1, types supported 125
  - tray 2, types supported 126
  - tray 3, types supported 126
  - troubleshooting 128
  - usage page 61
- memory
  - adding 134
  - DIMM slot errors 79
  - enabling 138
  - features 12
  - installing 135
  - Memory Enhancement technology (MEt) 12
  - NVRAM errors 78
  - overflow errors 77
  - part numbers 24
  - verifying installation 137
- mercury specifications 117
- messages
  - accessory errors 79
  - consumables status 72
  - HP Printer Status and Alerts 63
  - Macintosh 89
  - printer status 75
  - secondary, printer status 77
  - viewing with embedded Web server 60
  - Windows 89
- Microsoft Windows. *See* Windows
- models 10
- monitors, color matching 53
- multiple pages per sheet 40
- multipurpose paper, HP 25
- multipurpose tray. *See* tray 1

**N**

- Netscape Navigator, versions supported 58
- networks
  - accessories, ordering 3, 24
  - compatible models 12
  - configuring with embedded Web server 62
  - HP Printer Status and Alerts 17, 63
  - information pages, printing 56
  - installing HP Jetdirect print servers 139
  - software for 19

- status, viewing with embedded Web server 60
- troubleshooting 91
- Neutral Grays options 52
- noise specifications 115
- non-HP print cartridges 103
- nonvolatile memory (NVRAM) errors 78
- not printing, troubleshooting 90, 93
- N-up printing 40
- NVRAM (nonvolatile memory) errors 78

## O

- on/off switch 13
- online customer support 3
- online Help
  - printer drivers 37
- on-site service agreements 108, 118
- operating environment, specifications 115
- operating systems supported 17
- optional tray 2. *See* tray 2
- optional tray 3. *See* tray 3
- options. *See* settings
- ordering supplies and accessories 3, 24
- OS/2 support 17
- output bins
  - features 11
  - jams, clearing 69
  - locating 13
  - selecting 42
  - troubleshooting curl 94
- output quality
  - HP ImageREt 2400 50
  - settings 41
  - specifications 11
  - troubleshooting 80
- overhead transparencies
  - printing 45
  - specifications 125, 132
- ozone specifications 116

## P

- packaging printer 110
- Page Setup 34
- page skew, troubleshooting 85
- pages per minute 11
- pages per sheet 40
- paper
  - cardstock 46
  - custom-sized 39, 46
  - first page, different 41
  - HP, ordering 25
  - jams 66
  - letterhead 47
  - loading trays 31
  - long 31
  - output options 42
  - selecting 30, 124
  - sizes and types supported 29
  - specifications 127
  - tray 1, types supported 125
  - tray 2, types supported 126
  - tray 3, types supported 126
  - troubleshooting 128
  - usage page 61
- paper input trays
  - configuring 60
  - default 28
  - features 11
  - included 10
  - jams, clearing 68
  - loading 31

- locating 13
- media supported 29, 125
- ordering 3
- part numbers 24, 25
- selecting 34, 38
- troubleshooting 92

- paper output bins
  - features 11
  - jams, clearing 69
  - locating 13
  - selecting 42
  - troubleshooting curl 94
- parallel cables, ordering 3, 24
- parallel port
  - connecting to 14
  - locating 13
  - type included 11
- parts
  - ordering 3
  - part numbers 24
  - user replaceable 25
- passwords, network 61
- paused printing 16
- PCL drivers
  - backward compatibility 18
  - features 11
  - operating systems supported 17
  - settings 38
- PDEs, Macintosh 20
- permanent storage 78
- personalities
  - errors 78
  - features 11
- phone numbers
  - HP fraud hotline 103
  - HP Printing Supplies Returns and Recycling Program 117
  - support 3
- pick-up rollers, ordering 25
- platforms supported 17
- ports
  - cables, ordering 24
  - connecting to 14
  - locating 13
  - troubleshooting 93, 98
  - types included 11
- PostScript
  - driver settings 38
  - errors 96
  - features 11
  - operating systems supported 17
- power
  - consumption 116
  - requirements 114
  - switch 13
  - troubleshooting 90
- PPDs, Macintosh 20
- preprinted paper
  - output path 42
  - printing on 47
  - specifications 128
- print cartridges
  - empty or missing, light messages 73
  - HP fraud hotline 103
  - life expectancy 101
  - low 72
  - non-HP 74
  - ordering 3
  - part numbers 24
  - recycling 117
  - replacing 102
  - status lights 15, 72

- status page, printing 57
- status, viewing with embedded Web server 61
- storage specifications 115
- Print dialog box 34
- print media. *See* media
- print quality
  - HP ImageREt 2400 50
  - settings 41
  - specifications 11
  - troubleshooting 80
- print servers
  - configuring 62
  - EIO port errors 79
  - HP Printer Status and Alerts 17, 63
  - information page, printing 56
  - installing 139
  - models including 12
  - ordering 3
  - part numbers 24
  - troubleshooting 91
- printer drivers
  - downloading 21
  - features 38
  - Macintosh 20
  - opening 34
  - operating systems supported 17
  - restoring default settings 41
  - settings, changing 37
  - uninstalling 22
  - Windows, features 18
- printer languages
  - errors 78
  - features 11
- Printer Status and Alerts
  - operating systems supported 17
  - toner level, checking from 102
  - using 63
- printing
  - both sides 48
  - canceling 49
  - Macintosh 36
  - troubleshooting 90, 93
  - Windows 35
- problem solving. *See* troubleshooting
- processing message 75
- programs, settings 21
- properties. *See* settings
- PS
  - driver settings 38
  - errors 96
  - features 11
  - operating systems supported 17

## Q

- quality
  - HP ImageREt 2400 50
  - settings 41
  - specifications 11
  - troubleshooting 80
- Quick Sets 40

## R

- read me file 58
- Ready light 16, 75
  - See also* lights
- rear output door
  - features 11
  - locating 13
  - printing to 42
- recycled paper 30

- recycling
  - plastics 116
  - print cartridges 117
- reducing documents 40
- refilled print cartridges 103
- refilling paper 31
- regulatory statements
  - declaration of conformity 120
  - FCC 119
  - laser safety 121
  - Material Safety Data Sheet 118
- repacking printer 110
- repair. *See* service
- repetitive defects, troubleshooting 84, 85
- replacement parts. *See* supplies; service
- replacing print cartridges 102
- reports, printing 56
- resizing documents 40
- resolution
  - HP ImageREt 2400 50
  - settings 41
  - specifications 11
  - troubleshooting print quality 80
- restoring default settings 41
- resuming printing 16
- RGB color options 52, 53
- rollers, ordering 25
- Rotate Carousel button 15

## S

- saving settings 40
- scaling documents 40
- scanners, color matching 53
- scatter, troubleshooting 85
- screen color matching 53
- secondary messages
  - accessory errors 79
  - printer status lights 77
- security page, embedded Web server 61
- separation pad, ordering 25
- servers
  - configuring 62
  - EIO port errors 79
  - HP Printer Status and Alerts 17, 63
  - information page, printing 56
  - installing 139
  - models including 12
  - ordering 3
  - part numbers 24
  - troubleshooting 91
- service
  - agreements 108, 118
  - errors 76
  - HP Express Exchange 109
  - information form 111
  - part numbers 24
  - phone numbers 3
  - repacking printer 110
- settings
  - changing 21, 37
  - color 51
  - embedded Web server 61
  - restoring defaults 41
  - saving 40
- shipping printer 110
- size, printer 114
- sizes, media
  - custom 39, 46
  - selecting trays 34
  - supported 29

- tray 1 125
- tray 2 126
- tray 3 126
- skew, troubleshooting 85
- slanted pages 85
- slow printing, troubleshooting 92
- smeared toner, troubleshooting 83
- Smooth halftone option 52
- software
  - downloading 21
  - embedded Web server 60
  - features 38
  - HP Printer Status and Alerts 63
  - Macintosh, features 20
  - operating systems supported 17
  - settings, changing 37
  - Toolbox 58
  - uninstalling 22
  - Windows, features 18
- source, printing by 34, 38
- spare parts. *See* supplies; service
- special media
  - cardstock 46
  - custom-sized 39, 46
  - envelopes 43, 130
  - labels 44, 132
  - letterhead 47, 128
  - output path 42
  - specifications 125
  - transparencies 45, 132
- specifications
  - envelopes 130
  - environmental 115
  - labels 132
  - Material Safety Data Sheet 118
  - paper 127
  - printer 114
  - printer features 11
  - transparencies 132
  - trays, media supported 125
- specks, troubleshooting 82
- speed
  - specifications 11
  - troubleshooting 92
- spots, troubleshooting 82
- sRGB 52, 53
- status
  - e-mail alerts 61
  - HP Printer Status and Alerts 17, 63
  - lights. *See* lights
  - Supplies Status page, printing 57
  - viewing with embedded Web server 60
  - viewing with Toolbox 58
- stopping printing 49
- storing
  - envelopes 130
  - paper 129
  - print cartridges 102
  - printer 115
- straight-through paper path 42
- streaks, troubleshooting 82
- supplies
  - availability 118
  - life expectancies 101
  - ordering 3
  - recycling 117
  - specifications 114
  - status lights 15, 72
  - status page 57, 61

- support
  - HP Express Exchange 109
  - maintenance agreements 108, 118
  - part numbers 24
  - repacking printer 110
  - service information form 111
  - telephone and online 3
- Support Assistant CD 3
- SupportPack, HP 108, 118

## T

- technical support
  - HP Express Exchange 109
  - maintenance agreements 108, 118
  - part numbers 24
  - repacking printer 110
  - service information form 111
  - telephone and online 3
- telephone numbers
  - HP fraud hotline 103
  - HP Printing Supplies Returns and Recycling Program 117
  - support 3
- temperature specifications
  - paper, storing 129
  - printer environment 115
- temporary engine errors 77
- text, troubleshooting 84, 95
- toner
  - low 72
  - out 73
  - scatter, troubleshooting 85
  - smeared, troubleshooting 83
  - specks, troubleshooting 82
  - status lights 15
- toner cartridges. *See* print cartridges
- Toolbox
  - calibrating printer 100
  - operating systems supported 17
  - using 58
- top cover, locating 13
- top output bin
  - features 11
  - locating 13
  - printing to 42
  - troubleshooting curl 94
- transparencies
  - printing 45
  - specifications 125, 132
- Trapping options 52
- tray 1
  - See also* trays
  - loading 31
  - locating 13
  - media supported 29, 125
- tray 2
  - See also* trays
  - loading 32
  - locating 13
  - media supported 29, 126
  - models including 10
  - part number 24
  - size specifications 114
  - troubleshooting 93
- tray 3
  - See also* trays
  - loading 33
  - media supported 30, 126
  - models including 10
  - part number 25

- size specifications 114
- troubleshooting 93
- trays
  - configuring 60
  - default 28
  - features 11
  - included 10
  - jams, clearing 68
  - loading 31
  - locating 13
  - media supported 29, 125
  - ordering 3
  - part numbers 24, 25
  - selecting 34, 38
  - troubleshooting 92
- troubleshooting
  - accessory errors 79
  - blank pages 94
  - calibrating printer 100
  - cleaning printer 59
  - color 87
  - Configuration page, printing 56
  - consumables status messages 72
  - control panel messages 71
  - curl 84, 94
  - Demo page, printing 56
  - diagnostic pages 59
  - EPS files 97
  - faded print 82
  - fonts 96, 97
  - jams 66
  - Limit Check errors 89
  - lines 82
  - Macintosh problems 97
  - media 128
  - PostScript (PS) errors 96
  - printer status messages 75
  - printing 90, 93
  - print-quality problems 80
  - repetitive defects 84, 85
  - replacing print cartridges 102
  - secondary printer status messages 77
  - skewed pages 85
  - slow printing 92
  - text 95
  - toner smear 82
  - trays 92
  - Windows error messages 89
  - wrinkles 85
- Troubleshooting tab, Toolbox 59
- TrueType fonts, included 11
  - See also* fonts
- two-sided printing 48
- typefaces. *See* fonts
- types, media
  - selecting trays by 34, 38
  - supported 29
  - tray 1 125
  - tray 2 126
  - tray 3 126

## U

- uninstalling software 22
- UNIX support 17
- upgrading memory 134
- Usage page 61
- USB cables, ordering 3, 24
- USB port
  - connecting to 14
  - locating 13

- troubleshooting 98
- type included 11
- user guide
  - accessing 58
  - part numbers 25
- user replaceable parts 25

## V

- vertical lines, troubleshooting 82
- voltage requirements 114

## W

- warranty
  - extended 108, 118
  - printer 106
- watermarks 39
- wave, troubleshooting 84, 94
- Web browser requirements 58
- Web Jetadmin
  - operating systems supported 17
  - toner level, checking from 102
  - using 19
- Web server, embedded
  - operating systems supported 17
  - toner level, checking from 102
  - using 60
  - viewing with HP Printer Status and Alerts 63
- websites
  - customer support 3
  - HP Printing Supplies Returns and Recycling Program 117
  - HP Web Jetadmin 19
  - linking to embedded Web server 61
  - Material Safety Data Sheet 118
- weight
  - media specifications 125
  - printer 114
- Windows
  - driver features 38
  - driver Help 37
  - error messages 89
  - printing from 35
  - settings 37
  - uninstalling software 22
  - versions supported 17
- wrinkles, troubleshooting 85

## Y

- Yellow cartridge
  - See also* cartridges
  - empty or missing, light messages 73
  - life expectancy 101
  - low 72
  - non-HP 74
  - part number 24
  - status light 15, 72





i n v e n t

copyright © 2003  
Hewlett-Packard Company

[www.hp.com](http://www.hp.com)



C9706-90960