



HP LaserJet Pro Color MFP M476

Repair Manual



M476dn
M476dw
M476nw



www.hp.com/support/colorljMFPM476
www.hp.com/support



HP Color LaserJet Pro MFP M476

Replace and Repair Manual

Copyright and License

© 2014 Copyright Hewlett-Packard Development Company, L.P.

Reproduction, adaptation, or translation without prior written permission is prohibited, except as allowed under the copyright laws.

The information contained herein is subject to change without notice.

The only warranties for HP products and services are set forth in the express warranty statements accompanying such products and services. Nothing herein should be construed as constituting an additional warranty. HP shall not be liable for technical or editorial errors or omissions contained herein.


Edition 1, 04/2014


Trademark Credits


Microsoft®, Windows®, Windows® XP, Windows Vista®, Windows® 7, Windows® 8, and Windows® 8.1 are U.S. registered trademarks of Microsoft Corporation.

ENERGY STAR and the ENERGY STAR mark are registered U.S. marks.

Conventions used in this guide

 **TIP:** Tips provide helpful hints or shortcuts.

 **NOTE:** Notes provide important information to explain a concept or to complete a task.

 **CAUTION:** Cautions indicate procedures that you should follow to avoid losing data or damaging the product.


 **WARNING!** Warnings alert you to specific procedures that you should follow to avoid personal injury, catastrophic loss of data, or extensive damage to the product.

Table of contents

1 Removal and replacement	1
Removal and replacement strategy	2
Introduction	2
Considerations during removal and replacement	2
Electrostatic discharge	2
Required tools	3
Accessing the 2ndary service menu	4
Fasteners used in this product	5
Service approach	6
Before performing service	6
After performing service	6
Post-service tests	7
Print-quality test	7
Copy quality test	7
Fax quality test (fax models only)	7
Removal and replacement procedures	8
Rollers and pads	8
Transfer roller	8
Pickup roller (Tray 2 or Tray 3)	9
Separation roller (Trays 2 or 3)	11
Reinstall the separation roller	12
Document feeder pickup roller assembly	13
Pickup roller and separation pad (Tray 1)	14
Scanner and document feeder	17
Scanner assembly	17
Document feeder	18
Remove the scanner cable cover	18
Remove the document feeder	21
Reinstall the document feeder	22
Covers and doors	22
Print-cartridge drawer	22
Right cover	25

Right-front cover and power button	26
Rear-upper cover	28
Paper-feed guide assembly	29
Rear door	30
Rear-lower cover and rear-door links	32
Remove the rear-lower cover and rear-door links	32
Rear-door rib assembly	36
Remove the rear-door rib assembly	36
Control panel and right-arm mount	39
Reinstall the control panel and right-arm mount	40
Upper-cover assembly	42
Remove the upper-cover assembly	42
Reinstall the upper-cover assembly	43
Left cover	45
Remove the left cover	45
Reinstall the left cover	47
Front-door assembly	48
Remove the front-door assembly	48
Internal assemblies	54
Intermediate transfer belt (ITB)	54
Reinstall the ITB	57
Drum motor (M1) and developer motor (M2)	58
Reinstall the drum motor (M1) and developer motor (M2)	63
Intermediate PCA	64
Formatter PCA	65
Remove the formatter PCA	65
Fax PCA	66
Wireless PCA	68
DC controller PCA	69
Remove the DC controller PCA	69
Fuser-motor assembly	71
Remove the fuser-motor assembly	71
Reinstall the fuser-motor assembly	74
High-voltage power-supply PCA	75
Remove the high-voltage power-supply PCA	75
Color-misregistration sensor assembly	78
Remove the color-misregistration sensor assembly	78
Reinstall the color-misregistration sensor assembly	80
Fan (FM1)	82
USB PCA (fax/memory-card models)	83
Remove the USB PCA	83

Duplex-reverse drive assembly	84
Remove the duplex-reverse drive assembly	84
Fuser	87
Remove the fuser	87
Reinstall the fuser	92
Paper-delivery assembly	93
Remove the paper-delivery assembly	93
Low voltage power supply	95
Trays	104
Tray cassettes and optional Tray 3 assembly	105

2 Parts and diagrams 107

Order parts, accessories, and supplies	108
Orderable parts	109
Accessories	109
Toner cartridges	109
Customer self repair (CSR) and service kits	109
Whole unit replacement (WUR)	110
Service parts	111
Related documentation and software	111
How to use the parts lists and diagrams	112
Scanner and document feeder main assembly	114
Covers	116
Internal assemblies	118
Internal assemblies (1 of 7)	118
Internal assemblies (2 of 7)	120
Internal assemblies (3 of 7)	122
Internal assemblies (4 of 7)	124
Internal assemblies (5 of 7)	126
Internal assemblies (6 of 7)	128
Internal assemblies (7 of 7)	130
PCAs	132
Accessories	134
250-sheet paper feeder accessory kit (optional Tray 3)	134
Alphabetical parts list	136
Numerical parts list	139

Index 143

List of tables

Table 1-1	Common fasteners	5
Table 2-1	Accessories	109
Table 2-2	Toner cartridges	109
Table 2-3	Customer self repair (CSR) and service kits	109
Table 2-4	Pro 400 Color MFP M476 nw	110
Table 2-5	Pro 400 Color MFP M476 dn	110
Table 2-6	Pro 400 Color MFP M476 dw	110
Table 2-7	Service parts	111
Table 2-8	Related documentation and software	111
Table 2-9	Scanner and document feeder main assembly	115
Table 2-10	Covers	117
Table 2-11	Internal assemblies (1 of 7)	119
Table 2-12	Internal assemblies (2 of 7)	121
Table 2-13	Internal assemblies (3 of 7)	123
Table 2-14	Internal assemblies (4 of 7)	125
Table 2-15	Internal assemblies (5 of 7)	127
Table 2-16	Internal assemblies (6 of 7)	129
Table 2-17	Internal assemblies (7 of 7)	131
Table 2-18	PCAs	133
Table 2-19	250-sheet paper feeder accessory kit (optional Tray 3)	135
Table 2-20	Alphabetical parts list	136
Table 2-21	Numerical parts list	139

List of figures

Figure 1-1	Phillips and pozidrive screwdriver comparison	3
Figure 1-2	Raise the front of the product	10
Figure 1-3	Remove the pickup roller	10
Figure 1-4	Remove the pickup roller (1 of 3)	11
Figure 1-5	Remove the separation roller (2 of 3)	11
Figure 1-6	Remove the separation roller (3 of 3)	12
Figure 1-7	Reinstall the separation roller	12
Figure 1-8	Open the jam-access cover	13
Figure 1-9	Remove the document feeder pickup roller assembly	13
Figure 1-10	Remove the Tray 1 pickup roller (1 of 3)	14
Figure 1-11	Raise the front of the product	15
Figure 1-12	Remove the Tray 1 pickup roller (3 of 3)	15
Figure 1-13	Remove the Tray 1 separation pad	16
Figure 1-14	Disconnect the ground cable, connector, and FFCs	17
Figure 1-15	Remove four screws	17
Figure 1-16	Lift and slide the scanner assembly	18
Figure 1-17	Lift the scanner up and off the product	18
Figure 1-18	Turn the scanner assembly over	19
Figure 1-19	Remove three screws, then remove the cable cover	20
Figure 1-20	Remove three screws, then remove the cable cover	20
Figure 1-21	Release the cables	21
Figure 1-22	Remove the document feeder assembly	21
Figure 1-23	Remove the print-cartridge drawer (1 of 3)	23
Figure 1-24	Remove the print-cartridge drawer (2 of 3)	23
Figure 1-25	Remove the print-cartridge drawer (3 of 3)	24
Figure 1-26	Remove the right cover (1 of 2)	25
Figure 1-27	Remove the right cover (2 of 2)	25
Figure 1-28	Remove the rear-upper cover (1 of 2)	28
Figure 1-29	Remove the rear-upper cover (2 of 2)	28
Figure 1-30	Remove the feed assembly (1 of 2)	29
Figure 1-31	Remove the feed assembly (2 of 2)	29
Figure 1-32	Close the duplex-feed assembly	30

Figure 1-33	Remove two screws	30
Figure 1-34	Remove the rear door	31
Figure 1-35	Remove the rear- lower cover and rear-door links (1 of 6)	32
Figure 1-36	Remove the rear-lower cover and rear-door links (2 of 6)	33
Figure 1-37	Remove the rear-lower cover and rear-door links (3 of 6)	33
Figure 1-38	Remove the rear-lower cover and link-guides (4 of 6)	34
Figure 1-39	Remove the rear-lower cover and link-guides (5 of 6)	34
Figure 1-40	Remove the rear-lower cover and rear-door links (6 of 6)	35
Figure 1-41	Remove the rear-door rib assembly (1 of 3)	36
Figure 1-42	Remove the rear-door rib assembly (2 of 3)	37
Figure 1-43	Remove the rear-door rib assembly (2 of 3)	37
Figure 1-44	Remove the rear-door rib assembly (3 of 3)	38
Figure 1-45	Disconnect FFCs and connectors and loosen ferrite	39
Figure 1-46	Remove four screws and disconnect the ground wire	39
Figure 1-47	Remove the right-arm mount	40
Figure 1-48	Install four screws and connect the ground wire	40
Figure 1-49	Connect FFCs and connectors and replace ferrite	41
Figure 1-50	Remove four screws	42
Figure 1-51	Raise the back of the cover up and off the product	42
Figure 1-52	Remove the upper-cover assembly	43
Figure 1-53	Reinstall the upper-cover assembly (1 of 3)	43
Figure 1-54	Reinstall the upper-cover assembly (2 of 3)	44
Figure 1-55	Reinstall the upper-cover assembly (3 of 3)	44
Figure 1-56	Remove the left cover (1 of 3)	45
Figure 1-57	Remove the left cover (2 of 3)	46
Figure 1-58	Remove the left cover (3 of 3)	46
Figure 1-59	Reinstall the left cover (1 of 2)	47
Figure 1-60	Reinstall the left cover (2 of 2)	47
Figure 1-61	Remove the front-door assembly (1 of 10)	48
Figure 1-62	Remove the front-door assembly (2 of 10)	49
Figure 1-63	Remove the front-door assembly (3 of 10)	49
Figure 1-64	Remove the front-door assembly (4 of 10)	50
Figure 1-65	Remove the front-door assembly (5 of 10)	50
Figure 1-66	Remove the front-door assembly (6 of 10)	51
Figure 1-67	Remove the front-door assembly (7 of 10)	51
Figure 1-68	Remove the front-door assembly (8 of 10)	52
Figure 1-69	Remove the front-door assembly (9 of 10)	52
Figure 1-70	Remove the front-door assembly (10 of 10)	53
Figure 1-71	Remove the ITB (1 of 6)	54
Figure 1-72	Remove the ITB (2 of 6)	54
Figure 1-73	Remove the ITB (3 of 6)	55

Figure 1-74	Remove the ITB (4 of 6)	55
Figure 1-75	Remove the ITB (5 of 6)	56
Figure 1-76	Remove the ITB (6 of 6)	56
Figure 1-77	Diagnostic page	57
Figure 1-78	Remove motor M1 and motor M2 (1 of 6)	58
Figure 1-79	Remove motor M1 and motor M2 (2 of 6)	59
Figure 1-80	Remove motor M1 and motor M2 (3 of 6)	60
Figure 1-81	Remove motor M1 and motor M2 (4 of 6)	61
Figure 1-82	Remove motor M1 and motor M2 (5 of 6)	61
Figure 1-83	Remove motor M1 and motor M2 (6 of 6)	62
Figure 1-84	Reinstall the motor M1 and motor M2 wire-harness retainer	63
Figure 1-85	Remove the Intermediate PCA (1 of 2)	64
Figure 1-86	Remove the Intermediate PCA (2 of 2)	64
Figure 1-87	Remove the formatter PCA (1 of 2)	66
Figure 1-88	Remove the formatter PCA (2 of 2)	66
Figure 1-89	Remove the fax PCA	67
Figure 1-90	Remove the wireless PCA	68
Figure 1-91	Remove the DC controller PCA (1 of 2)	70
Figure 1-92	Remove the DC controller PCA (2 of 2)	70
Figure 1-93	Remove the fuser-motor assembly (1 of 6)	71
Figure 1-94	Remove the fuser-motor assembly (2 of 6)	72
Figure 1-95	Remove the fuser-motor assembly (3 of 6)	72
Figure 1-96	Remove the fuser-motor assembly (4 of 6)	73
Figure 1-97	Remove the fuser-motor assembly (5 of 6)	73
Figure 1-98	Remove the fuser-motor assembly (6 of 6)	74
Figure 1-99	Reinstall the fuser-motor assembly	74
Figure 1-100	Remove the high-voltage power-supply PCA (1 of 5)	75
Figure 1-101	Remove the high-voltage power-supply PCA (2 of 5)	76
Figure 1-102	Remove the high-voltage power-supply PCA (3 of 5)	76
Figure 1-103	Remove the high-voltage power-supply PCA (4 of 5)	77
Figure 1-104	Remove the high-voltage power-supply PCA (5 of 5)	77
Figure 1-105	Remove the color-misregistration sensor assembly PCA (1 of 4)	78
Figure 1-106	Remove the color-misregistration sensor assembly PCA (2 of 4)	79
Figure 1-107	Remove the color-misregistration sensor assembly PCA (3 of 4)	79
Figure 1-108	Remove the color-misregistration sensor assembly PCA (4 of 4)	80
Figure 1-109	Reinstall the color-misregistration sensor assembly PCA (1 of 2)	80
Figure 1-110	Reinstall the color-misregistration sensor assembly PCA (2 of 2)	81
Figure 1-111	Remove the fan (FM1) (1 of 2)	82
Figure 1-112	Remove the fan (FM1) (2 of 2)	82
Figure 1-113	Remove the USB PCA (fax/memory-card models)	83
Figure 1-114	Remove the duplex-reverse drive assembly (1 of 4)	84

Figure 1-115	Remove the duplex-reverse drive assembly (2 of 4)	85
Figure 1-116	Remove the duplex-reverse drive assembly (3 of 4)	85
Figure 1-117	Remove the duplex-reverse drive assembly (4 of 4)	86
Figure 1-118	Remove the fuser (1 of 8)	87
Figure 1-119	Remove the fuser (2 of 8)	88
Figure 1-120	Remove the fuser (3 of 8)	88
Figure 1-121	Remove the fuser (4 of 8)	89
Figure 1-122	Remove the fuser (5 of 8)	89
Figure 1-123	Remove the fuser (6 of 8)	90
Figure 1-124	Remove the fuser (7 of 8)	90
Figure 1-125	Remove the fuser (8 of 8)	91
Figure 1-126	Reinstall the fuser	92
Figure 1-127	Remove the paper-delivery assembly (1 of 4)	93
Figure 1-128	Remove the paper-delivery assembly (2 of 4)	94
Figure 1-129	Remove the paper-delivery assembly (3 of 4)	94
Figure 1-130	Remove the paper-delivery assembly (4 of 4)	95
Figure 1-131	Remove three screws	96
Figure 1-132	Original routing of wires to be removed	97
Figure 1-133	DCC plugs disconnected	97
Figure 1-134	Unplugged wires have been removed from the wire guides and plugs from the Driver PCA have been disconnected	98
Figure 1-135	Disconnect the plug on the formatter board	98
Figure 1-136	Plastic wire frame	99
Figure 1-137	Tabs to release	99
Figure 1-138	Remove one screw	100
Figure 1-139	Remove one screw above and left of the power switch	100
Figure 1-140	Remove the screw holding the tray 3 harness in place	101
Figure 1-141	Remove the tray 3 harness and pin guide	101
Figure 1-142	Remove the screws securing the low voltage power supply	102
Figure 1-143	Remove the screw securing the top of the low voltage power supply	102
Figure 1-144	Lift the low voltage power supply	103
Figure 1-145	Disconnect two plugs	103
Figure 1-146	Remove the ground strap	104
Figure 1-147	Remove the low voltage power supply	104
Figure 1-148	Remove the tray cassettes and optional Tray 3 assembly (1 of 2)	105
Figure 1-149	Remove the tray cassettes and optional Tray 3 assembly (2 of 2)	105
Figure 2-1	Scanner and document feeder main assembly	114
Figure 2-2	External panels and covers	116
Figure 2-3	Internal assemblies (1 of 7)	118
Figure 2-4	Internal assemblies (2 of 7)	120
Figure 2-5	Internal assemblies (3 of 7)	122

Figure 2-6	Internal assemblies (4 of 7)	124
Figure 2-7	Internal assemblies (5 of 7)	126
Figure 2-8	Internal assemblies (6 of 7)	128
Figure 2-9	Internal assemblies (7 of 7)	130
Figure 2-10	PCAs	132
Figure 2-11	250-sheet paper feeder (optional Tray 3)	134

1 Removal and replacement

- [Removal and replacement strategy](#)
- [Service approach](#)
- [Removal and replacement procedures](#)

Removal and replacement strategy

Use this section to find procedures for the removal and replacement of field replaceable units (FRUs).

Introduction

This chapter describes the removal and replacement of field-replaceable units (FRUs) only.


Replacing FRUs is generally the reverse of removal. Occasionally, notes and tips are included to provide directions for difficult or critical replacement procedures.

HP does *not* support repairing individual subassemblies or troubleshooting to the component level.

Note the length, diameter, color, type, and location of each screw. Be sure to return each screw to its original location during reassembly.


Incorrectly routed or loose wire harnesses can interfere with other internal components and can become damaged or broken. Frayed or pinched harness wires can be difficult to find. When replacing wire harnesses, always use the provided wire loops, lance points, or wire-harness guides and retainers.


Considerations during removal and replacement


 **WARNING!** Turn the product off, wait 5 seconds, and then remove the power cord before attempting to service the product. If this warning is not followed, severe injury can result, in addition to damage to the product. The power must be on for certain functional checks during troubleshooting. However, disconnect the power supply during parts removal.

Never operate or service the product with the protective cover removed from the laser/scanner assembly. The reflected beam, although invisible, can damage your eyes.



The sheet-metal parts might have sharp edges. Be careful when handling sheet-metal parts.

 **CAUTION:** Do not bend or fold the flat flexible cables (FFCs) during removal or installation. Also, do not straighten pre-folds in the FFCs. You *must* fully seat all FFCs in their connectors. Failure to fully seat an FFC into a connector can cause a short circuit in a PCA.

 **NOTE:** To install a self-tapping screw, first turn it counterclockwise to align it with the existing thread pattern, and then carefully turn it clockwise to tighten. Do not overtighten. If a self-tapping screw-hole becomes stripped, repair the screw-hole or replace the affected assembly.

 **TIP:** For clarity, some photos in this chapter show components removed that would not be removed to service the product. If necessary, remove the components listed at the beginning of a procedure before proceeding to service the product.

Electrostatic discharge

 **CAUTION:**  Some parts are sensitive to electrostatic discharge (ESD). Look for the ESD reminder when removing product parts. Always perform service work at an ESD-protected workstation or mat, or use an ESD strap. If an ESD workstation, mat, or strap is not available, ground yourself by touching the sheet-metal chassis *before* touching an ESD-sensitive part.

Protect the ESD-sensitive parts by placing them in ESD pouches when they are out of the product.

Required tools

- Number 2 Phillips screwdriver with a magnetic tip and a 152-mm (6-inch) shaft length
- Precision slotted (flat head) screwdriver with a 1 mm (0.04 in) blade width

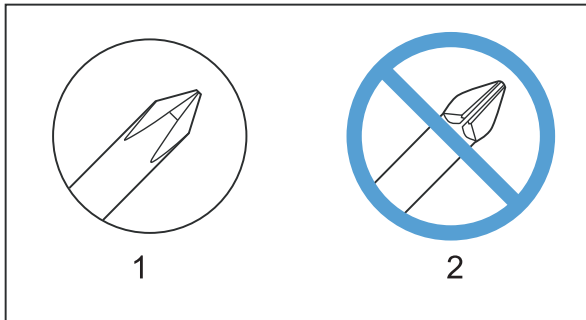


NOTE: This fine-point tool is required to release the front door pins. The width of the blade must be 2 mm (0.08 in) or less to be able to drive the door pins out of the mounting holes.


- Small, slotted (flat head) screwdriver
- Needle-nose pliers
- Snap-ring pliers
- ESD mat (if one is available)
- Penlight (optional)

CAUTION: Always use a Phillips screwdriver (callout 1). Do not use a pozidrive screwdriver (callout 2) or any motorized screwdriver. These can damage screws or screw threads.


Figure 1-1 Phillips and pozidrive screwdriver comparison



Accessing the 2ndary service menu

 **NOTE:** If the 2ndary Service menu bar does not appear, repeat steps 2 and 3.

1. On the Home screen of the touch display, touch **Setup Menu** to open the Setup menu.
2. On the Setup Menu screen of the touch display, simultaneously touch the hidden Left Arrow ◀ and Cancel ✕ icons.

 **NOTE:** The Left Arrow and Cancel icons might not be illuminated. Use the following image to make sure that you touch the correct areas of the touchscreen.




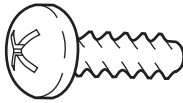

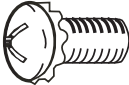
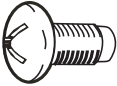
3. After pressing both symbols, the Home screen should reappear. Touch the Setup Menu icon to access the 2ndary Service Menu bar.
4. From the Service Menu, touch the 2ndary Service Menu bar.

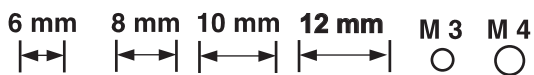
Fasteners used in this product

⚠ WARNING! Make sure that components are replaced with the correct screw type. Using the incorrect screw (for example, substituting a long screw for the correct shorter screw) can cause damage to the product or interfere with product operation. Do not intermix screws that are removed from one component by using the screws that are removed from another component.

📝 NOTE: The screw illustrations in the following table are for reference only. Screws might vary in size and appearance from those shown in this table.

Table 1-1 Common fasteners

Example	Description	Size	Part Number
	Screw, with washer	M3X8	XA9-1420-000CN
		M4X6	XB2-7400-605CN
		M4X12	XA9-1422-000CN
	Screw, tapping, truss head	M4X10	XB4-7401-005CN
		M4X15	XB4-7401-609CN
	Screw, TP	M3X4	XB6-7300-405CN
		M3X6	XB6-7300-605CN
	Screw, D	M3X6	XA9-1670-000CN
		M3X8	XA9-1671-000CN
	Screw, machine	M3X4	XB6-7300-409CN
	Screw, machine, flat head	M3X4	XA9-0679-000CN
	Screw, machine, flanged pan head	M3X6	XB6-7300-805CN



Service approach

Before performing service

- Remove all media from the product.
- Turn off the power using the power switch.
- Unplug the power cable and interface cable(s).
- Place the product on an ESD mat (if one is available). If an ESD workstation or mat is not available, ground yourself by touching the sheet-metal chassis *before* touching an ESD-sensitive part.
- Remove the toner cartridges.
- Remove the tray 2 cassette.

After performing service

- Connect the power cable.
- Reinstall the toner cartridges.
- Reinstall the tray 2 cassette.

Post-service tests

After service has been completed, perform the following tests to verify that the repair or replacement was successful.

Print-quality test

1. Verify that you have completed the necessary reassembly steps.
2. Make sure that the input tray contains clean, unmarked paper.
3. Attach the power cable and interface cable, and then turn on the product.
4. Verify that the expected start-up sounds occur.
5. Print a configuration page, and then verify that the expected printing sounds occur.
6. Print a demo page, and then verify that the print quality is as expected.
7. Send a print job from the host computer, and then verify that the output meets expectations.
8. If necessary, restore any customer-specified settings.
9. Clean the outside of the product by using a damp cloth.

Copy quality test

1. Verify that you have completed the necessary reassembly steps.
2. Perform steps 1-8 in test 1 to check basic print quality.
3. Place the configuration page in the document feeder.
4. Print a copy job, and then verify the results.
5. Clean the outside of the product by using a damp cloth.

Fax quality test (fax models only)

1. Place the configuration page in the document feeder.
2. Type a valid fax number and send the fax job.
3. Verify that the send quality and receive quality meet expectations.

Removal and replacement procedures


Rollers and pads

Transfer roller


The transfer roller is a component of the paper-feed assembly and not available as an individual FRU. To remove and replace the transfer roller, install a replacement paper-feed guide assembly. See [Paper-feed guide assembly on page 29](#).


Pickup roller (Tray 2 or Tray 3)

The roller must be rotated into the service position to remove it.

 **CAUTION:** Avoid touching the spongy roller surface unless you are going to replace the roller. Skin oils on the roller can cause paper pickup problems.


1. Turn the product on, and wait for it to reach the Ready state. Perform the following steps to rotate the roller to the service position.

 **NOTE:** If you have removed [Tray 2](#) to service the product, reinstall the tray before turning the power on.

 **TIP:** The following steps rotate the engine pickup roller *and* the [Tray 1](#) pickup roller into the service position.

- a. Open the 2ndary service menu. See [Accessing the 2ndary service menu on page 4](#)
- b. Scroll down, then touch the [Pick Roller](#) item.

Touch the [OK](#) button to confirm that you want the roller to rotate.
- c. Listen for the roller to rotate. When the roller is done rotating, unplug the power cable and then place the power button in the off position.

 **CAUTION:** It is important to place the power button in the off position **after** unplugging the power cable so that the product power does not come on immediately when the power cable is plugged in again.

- d. Remove [Tray 2](#).
- e. Perform the remaining steps in this procedure to remove the roller. After replacing the roller, plug the power cable into the product, and then use the power button to turn the power on.

2. Carefully raise the front of the product.

⚠ WARNING! Do not place the product face-up resting on the rear cover and rear door unless you have removed all toner cartridges. Excess toner might enter the laser/scanner assembly and contaminate the mirrors, causing print-quality problems. The laser/scanner is not a FRU. If the laser/scanner mirrors are contaminated, the entire product must be replaced.

⚠ CAUTION: The document feeder and scanner cover are not captive and can open suddenly when the product is placed front-side face up. Always support the document feeder and scanner cover before placing the product front-side face up.

Do not lift the product grasping the front door and Tray 2 cavity.

📝 NOTE: The roller is located inside the tray cavity.

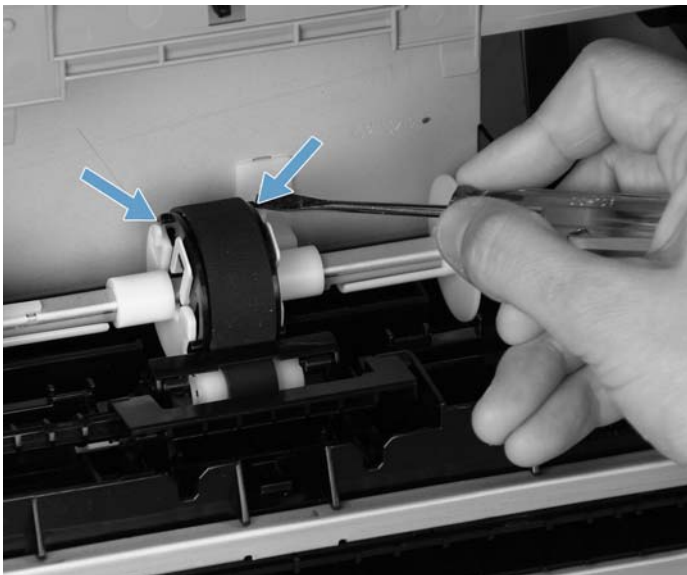
Figure 1-2 Raise the front of the product



3. Use a precision slotted (flat head) screwdriver to release two locking tabs and remove the pickup roller.

⚠ CAUTION: Do not touch the spongy roller surface unless you are going to replace the roller. Skin oils on the roller can cause paper pickup problems.

Figure 1-3 Remove the pickup roller



Separation roller (Trays 2 or 3)

CAUTION: Avoid touching the spongy roller surface unless you are going to replace the roller. Skin oils on the roller can cause paper pickup problems.

1. Remove Tray 2 (if installed), and then carefully raise the front of the product.

WARNING! Do not place the product face-up resting on the rear cover and rear door. Excess toner might enter the laser/scanner assembly and contaminate the mirrors, causing print-quality problems. The laser/scanner is not a FRU. If the laser/scanner mirrors are contaminated, the entire product must be replaced.

CAUTION: Do not lift the product grasping the front door and Tray 2 cavity.

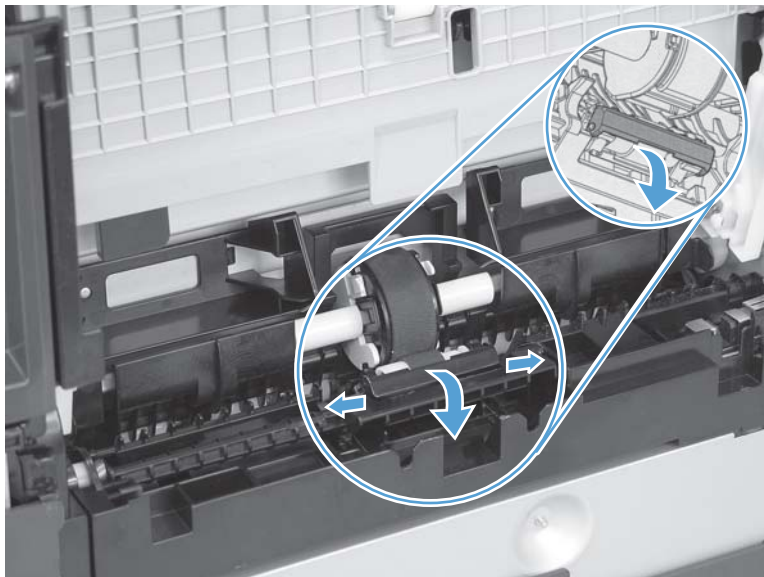
NOTE: The roller is located inside the tray cavity.

Figure 1-4 Remove the pickup roller (1 of 3)



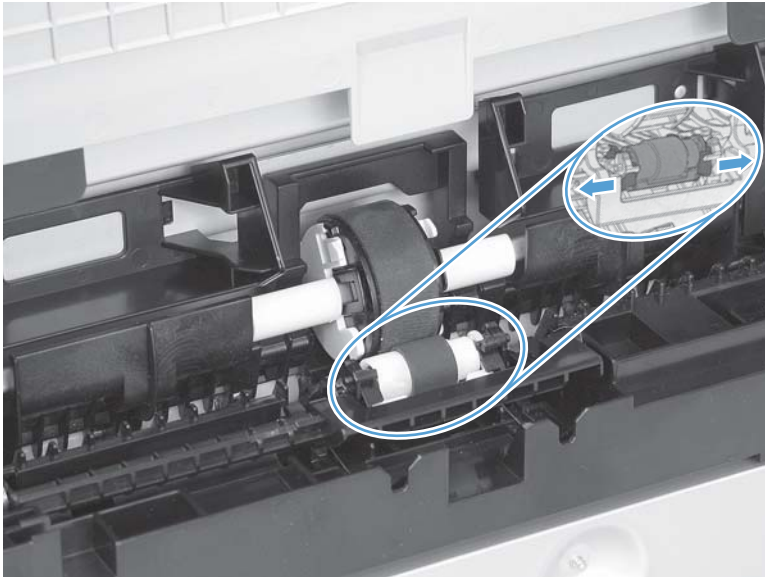
2. Shift the cover to one side and pull it over the shaft, then slide the cover the other way to slide it off the shaft and remove it.

Figure 1-5 Remove the separation roller (2 of 3)



3. Wedge a small precision slotted (flat head) screwdriver under the left side of the roller holder to release and remove the separation roller.

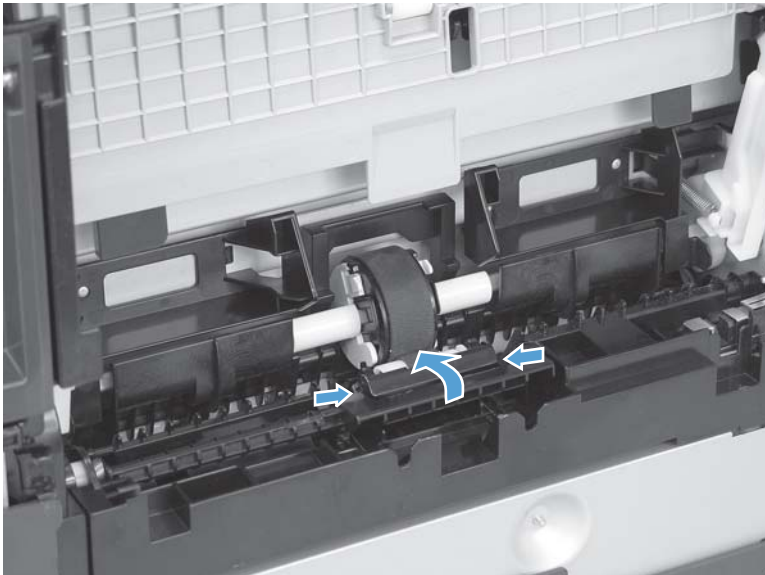
Figure 1-6 Remove the separation roller (3 of 3)



Reinstall the separation roller

1. Install the replacement separation roller.
2. Reinstall the separation roller cover on the locking pins, and then rotate it toward the roller until you hear it snap into place.

Figure 1-7 Reinstall the separation roller



Document feeder pickup roller assembly

⚠ CAUTION: Skin oils on the roller can cause paper pickup problems. Wash your hands before handling the assembly.

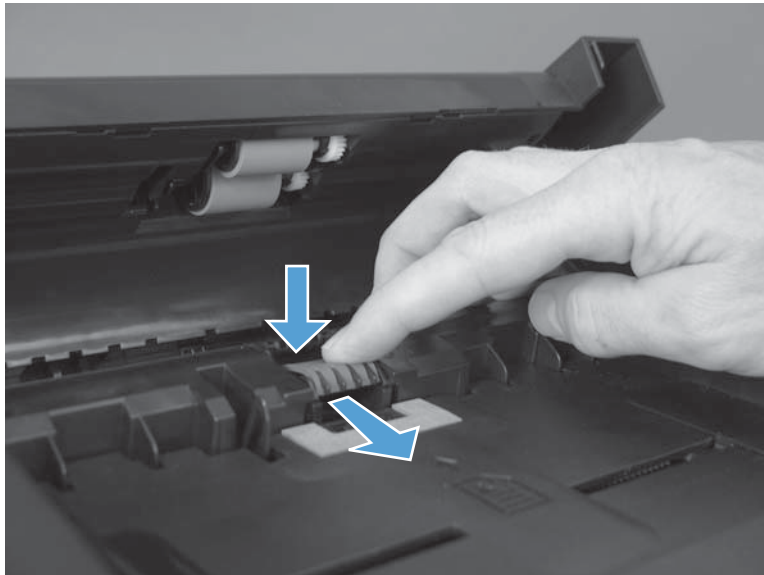
1. Open the jam-access cover.

Figure 1-8 Open the jam-access cover



2. Locate the separation pad at the end of the document feeder input tray, press down on the pad, and then slide the pad toward the input tray to remove it from the assembly.

Figure 1-9 Remove the document feeder pickup roller assembly



Pickup roller and separation pad (Tray 1)

The roller must be rotated into the service position to remove it.

CAUTION: Avoid touching the spongy roller surface unless you are going to replace the roller. Skin oils on the roller can cause paper pickup problems.

NOTE: Always replace the separation pad when replacing the pickup roller.

1. Turn the product on, and wait for it to reach the Ready state. Perform the following steps to rotate the roller to the service position.

NOTE: If you have removed **Tray 2** to service the product, reinstall the tray before turning the power on.

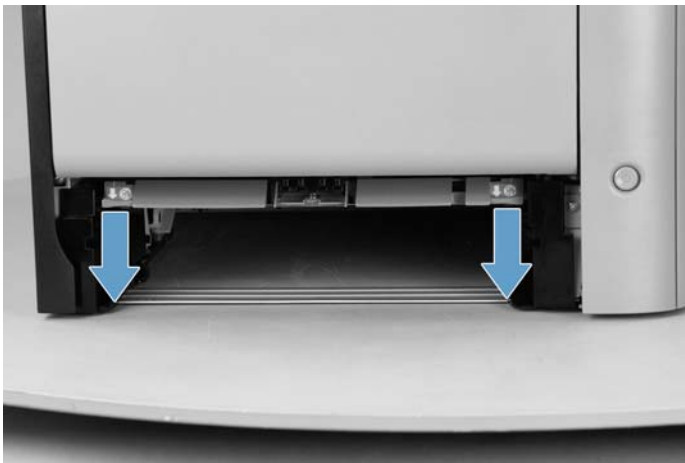
TIP: The following steps rotate the engine pickup roller *and* the **Tray 1** pickup roller into the service position.

- a. Open the 2ndary service menu. See [Accessing the 2ndary service menu on page 4](#)
- b. Use the arrow buttons to select **Pick Roller**, and then press the **OK** button.
Touch the **OK** button again to confirm that you want the roller to rotate.
- c. Listen for the roller to rotate. When the roller is done rotating, unplug the power cable.

NOTE: Failure to unplug the product at this point will result in the roller being in the incorrect position for the repair procedure.

- d. Remove **Tray 2**.
 - e. Perform the remaining steps in this procedure to remove the roller. After replacing the roller, plug the power cable into the product, and then use the power button to turn the power on.
2. Lower the Tray 1 paper pickup assembly by pushing down on the edges of the assembly.

Figure 1-10 Remove the Tray 1 pickup roller (1 of 3)



3. Carefully raise the front of the product.

⚠ WARNING! Do not place the product face-up resting on the rear cover and rear door. Excess toner might enter the laser/scanner assembly and contaminate the mirrors, causing print-quality problems. The laser/scanner is not a FRU. If the laser/scanner mirrors are contaminated, the entire product must be replaced.

⚠ CAUTION: The document feeder and scanner cover are not captive and can open suddenly when the product is placed front-side face up. Always support the document feeder and scanner cover before placing the product front-side face up.

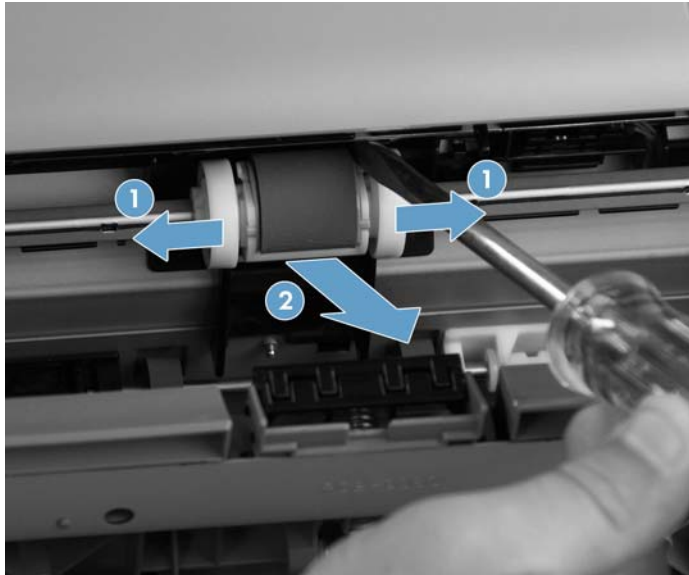
CAUTION: Do not lift the product grasping the front door and Tray 2 cavity.

Figure 1-11 Raise the front of the product



4. Release two tabs, and then rotate the roller away from the product to remove it.

Figure 1-12 Remove the Tray 1 pickup roller (3 of 3)



5. Release the retainer tabs, and then remove the separation pad from the base.


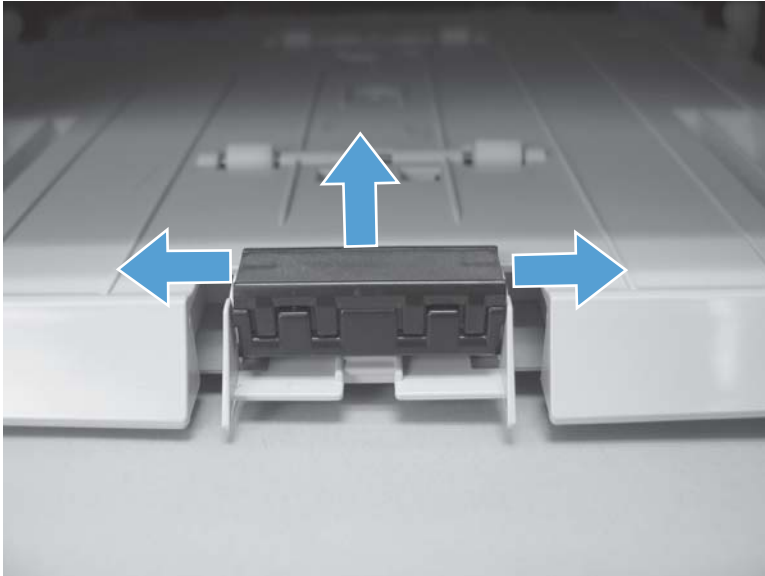
 **NOTE:** The separation pad base can easily be dislodged when the pad is removed. If the base is dislodged, do not lose the spring under the base (it is not captive).

Figure 1-13 Remove the Tray 1 separation pad



Scanner and document feeder

Scanner assembly

1. Remove the right cover. See [Right cover on page 25](#).
2. Disconnect one ground cable (callout 1), one connector (callout 2), and three FFCs (callout 3).

 **NOTE:** Use a small slotted (flat head) screwdriver to release the ferrite and expose the FFC.


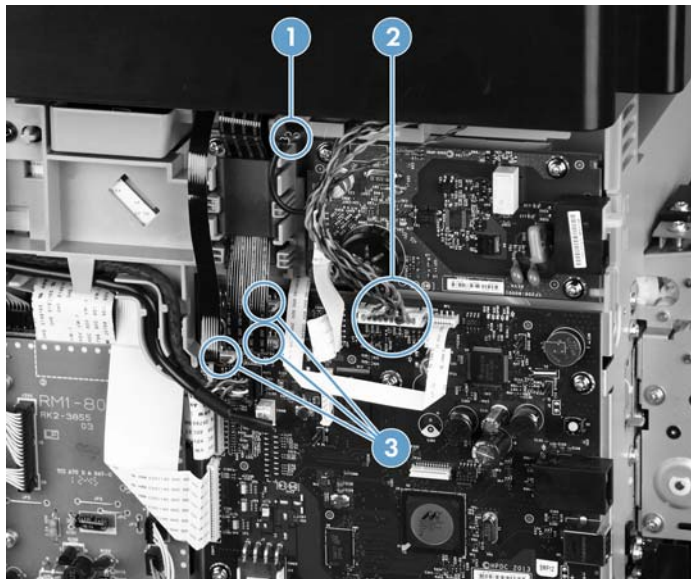
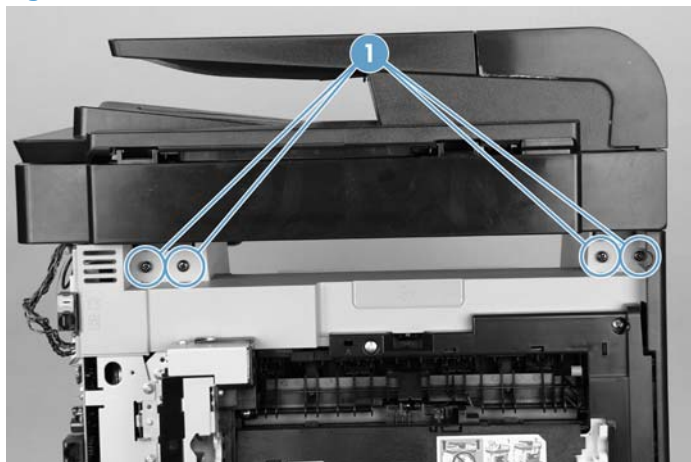
 **WARNING!** The ferrite and cable are fragile. Take care to not damage them when releasing the ferrite.

Figure 1-14 Disconnect the ground cable, connector, and FFCs



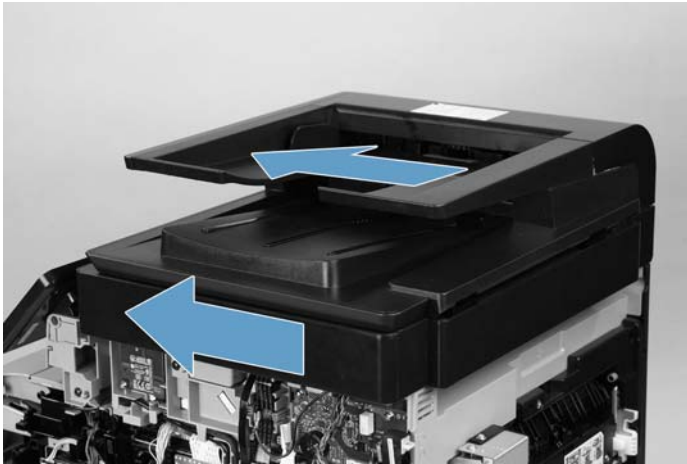
3. Remove four screws (callout 1).

Figure 1-15 Remove four screws



4. Slightly lift up the back of the scanner, and then slide it toward the front of the product.

Figure 1-16 Lift and slide the scanner assembly



5. Lift the scanner straight up and off of the product.

Figure 1-17 Lift the scanner up and off the product



Document feeder

Remove the scanner cable cover

Before proceeding, remove the following:

- Right cover.
- Scanner assembly/ADF.

1. Turn the scanner assembly/ADF over.

Figure 1-18 Turn the scanner assembly over



2. Use a small slotted (flat head) screw driver to remove three screws, then remove the cable cover.

Figure 1-19 Remove three screws, then remove the cable cover

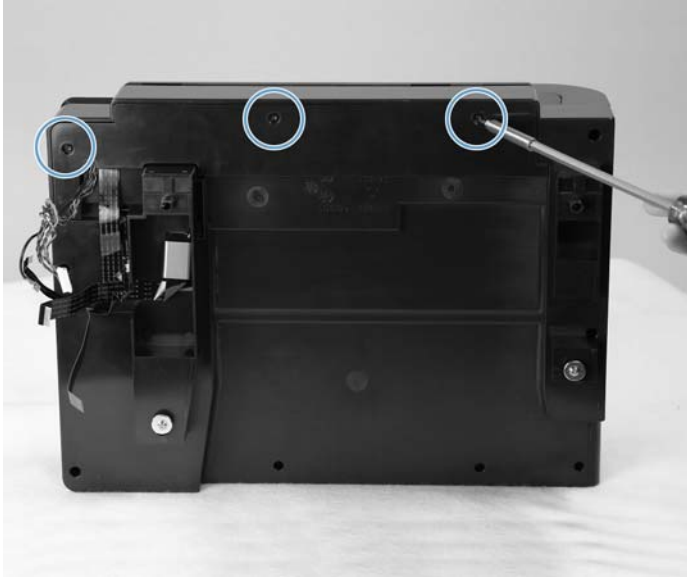
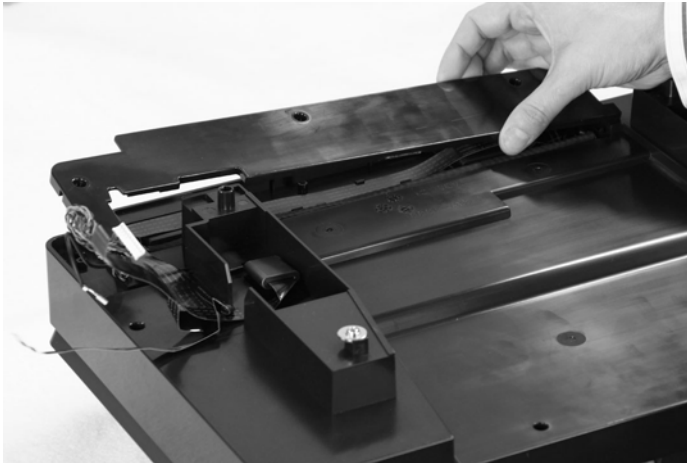
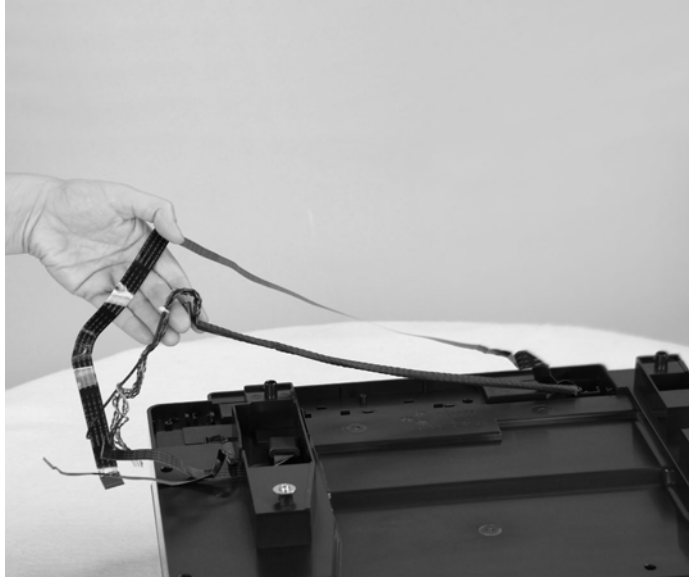


Figure 1-20 Remove three screws, then remove the cable cover




3. Release the cables from the cable guides.

Figure 1-21 Release the cables



Remove the document feeder

 **NOTE:** After removing the document feeder assembly, place it on a clean, dry, and smooth surface. Use a T10 screwdriver to remove the screws.

- ▲ Use a small slotted (flat head) screwdriver to release two tabs (callout 1) on the hinges, and then pull the document feeder straight up and off (callout 2) to remove it.


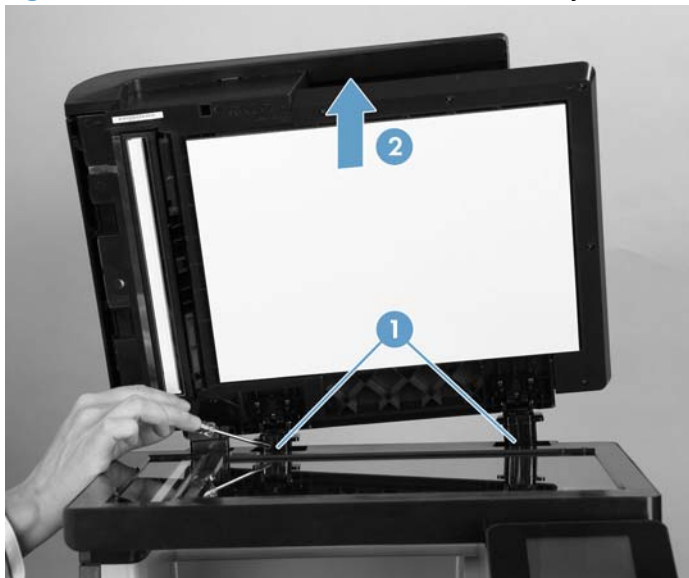
 **TIP:** Push the screwdriver down into the hinge wells to release the tabs.


Figure 1-22 Remove the document feeder assembly




Reinstall the document feeder

After replacing the document feeder, perform E-duplex calibration to make sure that the formatter and ADF are calibrated correctly.

1. To reinstall the document feeder, perform the steps in Remove the document feeder in reverse.

 **NOTE:** The cables connecting the document feeder to the scanner assembly are fragile. Be careful to not damage the cables while reinstalling the document feeder.

2. Power off the device, then turn it back on.
3. Cut down two plain sheets of white paper to measure 220 mm by 140 mm (8.65 in x 5.5 in) and place them in the ADF, long edge first.

 **NOTE:** The required sheet dimensions can be achieved by turning a sheet of Letter or A4 size paper on its side.

4. Open the 2ndary service menu. See [Accessing the 2ndary service menu on page 4](#)
5. Scroll down until eDuplexCalibration displays on the touchscreen, touch to select it, then touch OK .
6. The ADF pulls the paper into the product and the calibration begins. Although the process appears to be complete, continue to wait for 70 seconds after the sheets have been scanned before proceeding.
7. To exit the 2ndary Service menu, go to the Home screen, then simultaneously touch the hidden Left Arrow Left Arrow ◀ and Cancel Cancel ✕ icons.
8. Print a 2-sided copy and confirm that the output is acceptable.

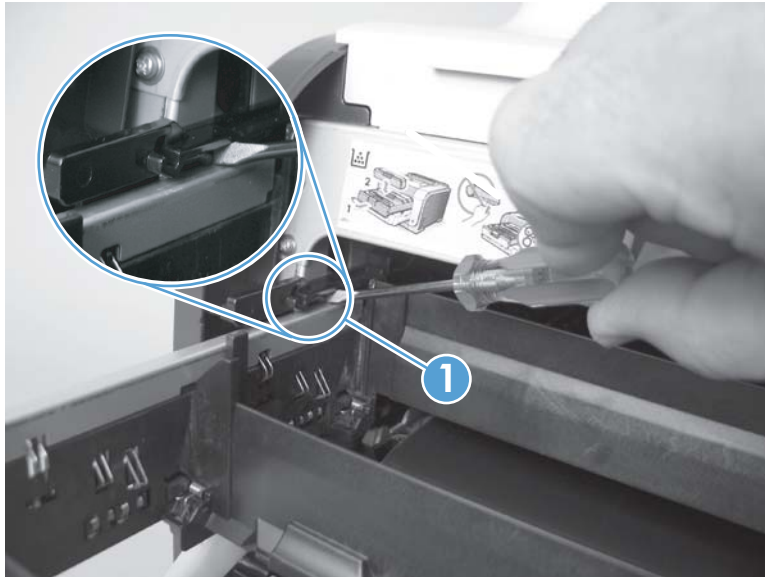
Covers and doors

Print-cartridge drawer

1. Open the front door.

2. Partially pull out the print-cartridge drawer, and then use a small flat blade screwdriver to release one tab (callout 1) on the left side of the product.

Figure 1-23 Remove the print-cartridge drawer (1 of 3)



3. Carefully rotate the print-cartridge drawer toward the right side of the product to release it.

Figure 1-24 Remove the print-cartridge drawer (2 of 3)



4. Pull the print-cartridge drawer out of the product to remove it.

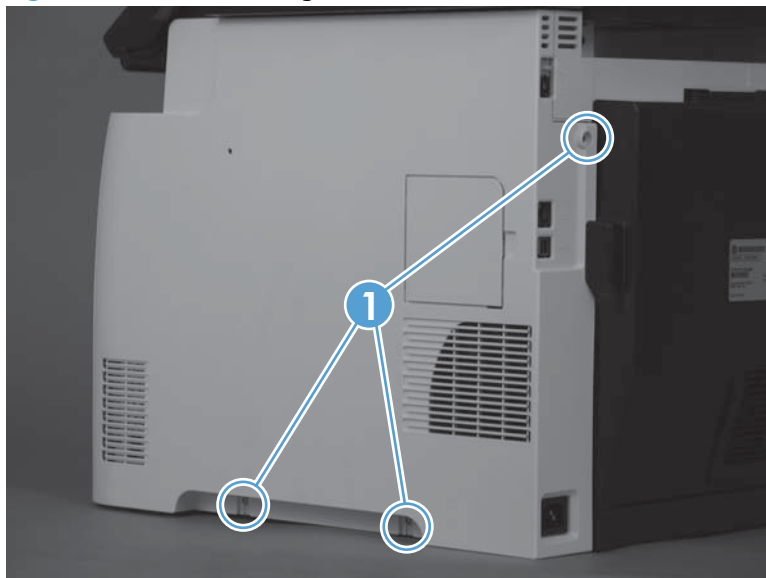
Figure 1-25 Remove the print-cartridge drawer (3 of 3)



Right cover

1. Open the rear door.
2. Remove three screws (callout 1).

Figure 1-26 Remove the right cover (1 of 2)



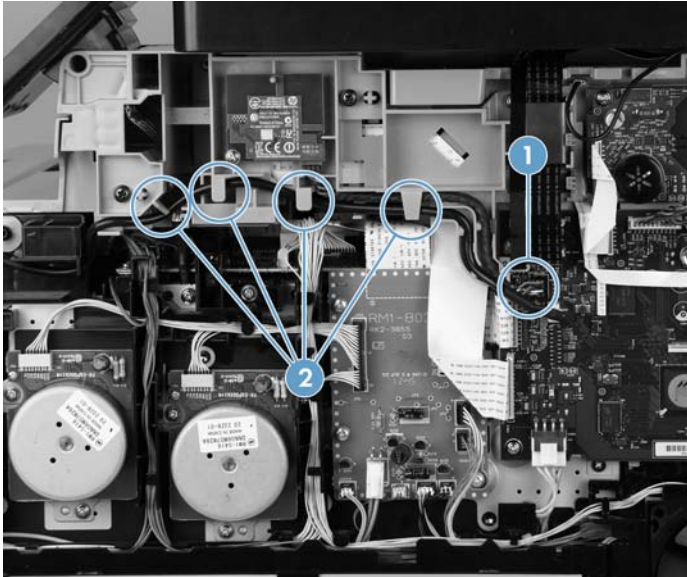
3. Slide the right cover toward the back of the product and remove the cover.

Figure 1-27 Remove the right cover (2 of 2)

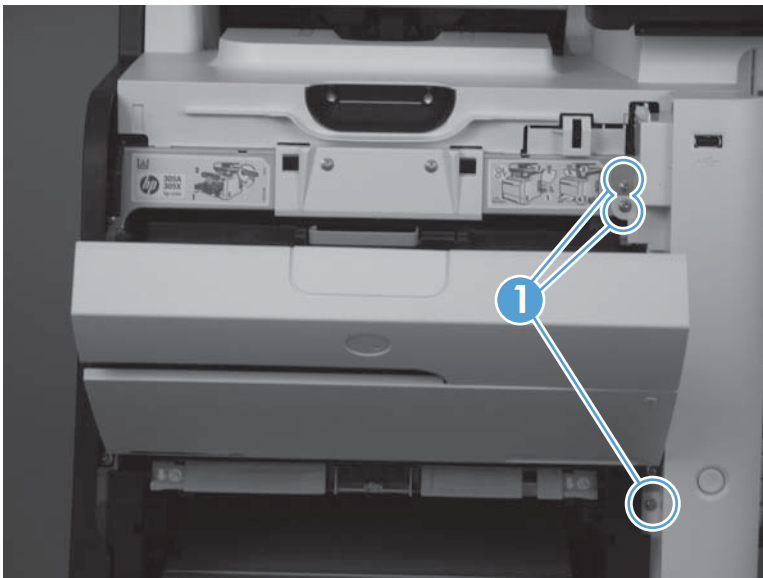


Right-front cover and power button

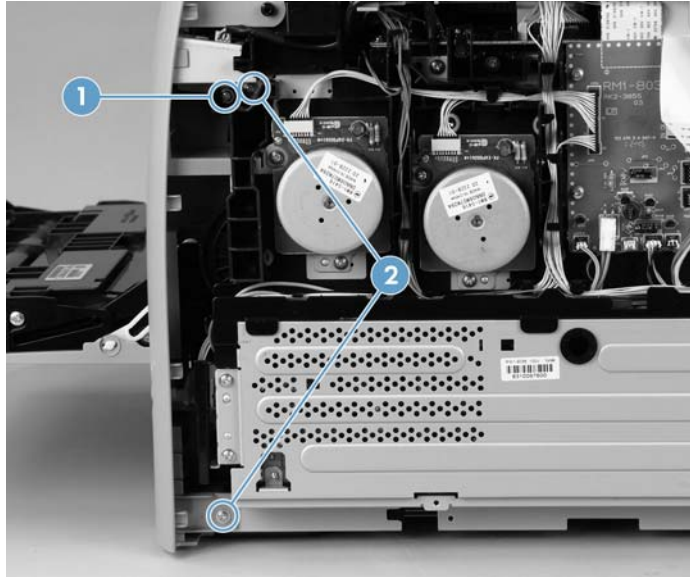
1. Remove the right cover. See [Right cover on page 25](#).
2. Disconnect the USB PCA connector from the formatter PCA (callout 1), and then release the wire from the retainer (callout 2).



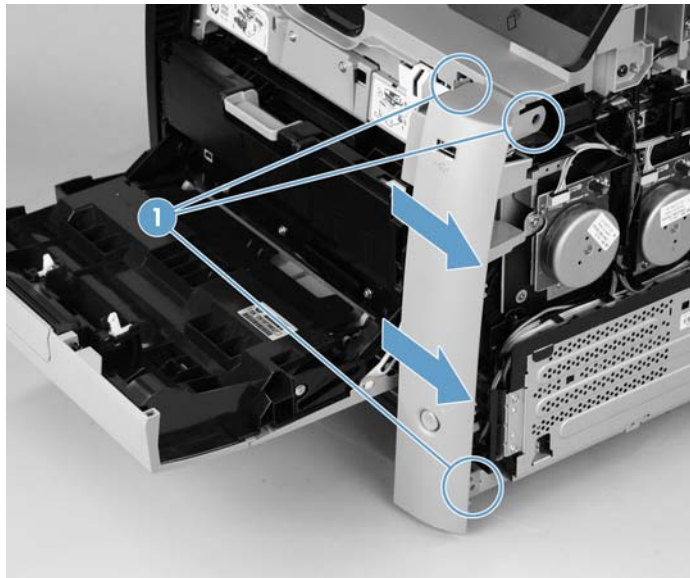
3. Open the front door, and then remove three screws (callout 1).



4. Remove one screw and retainer (callout 1), and then remove two screws (callout 2).



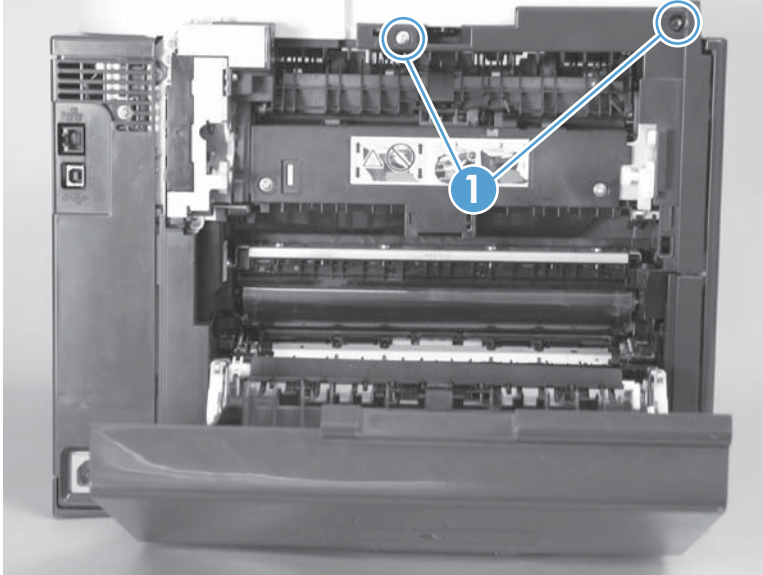
5. Slide the cover slightly toward the right to release three tabs (callout 1), and then remove the cover.



Rear-upper cover

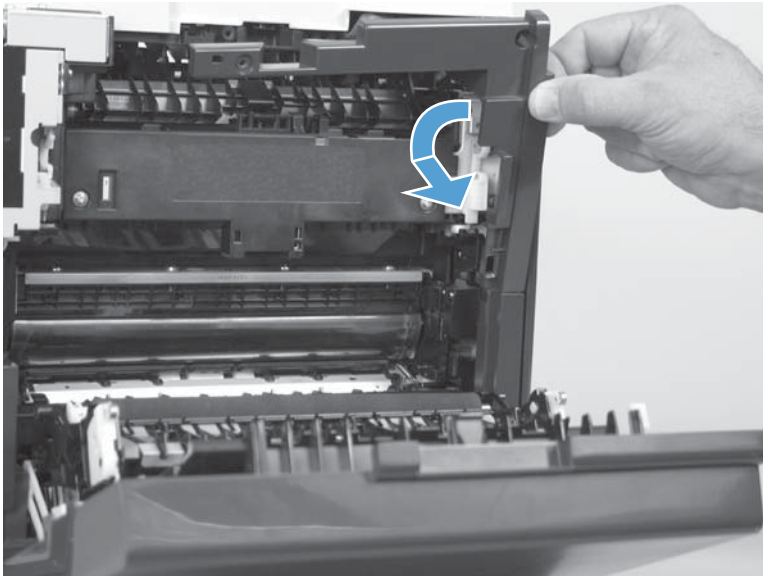
1. Open the rear door.
2. Remove two screws (callout 1).

Figure 1-28 Remove the rear-upper cover (1 of 2)



3. Slightly separate the cover from the product, and then rotate the cover down and then away from the product to remove it.

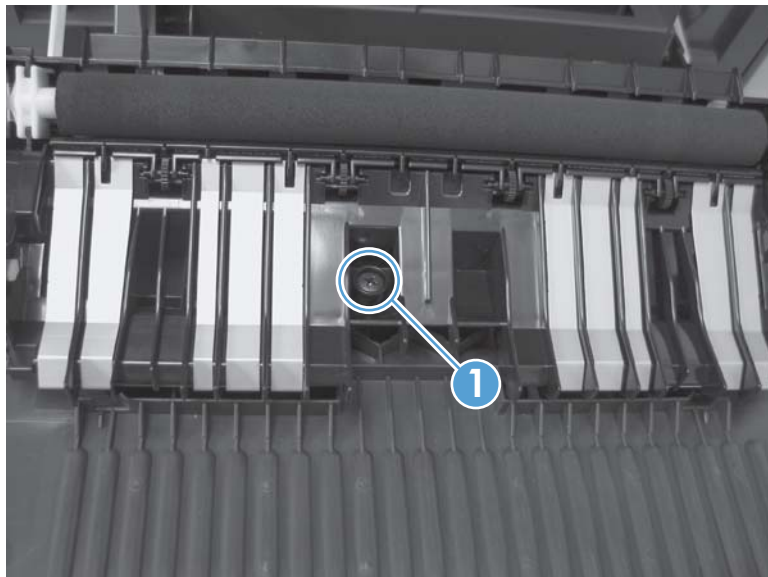
Figure 1-29 Remove the rear-upper cover (2 of 2)



Paper-feed guide assembly

1. Release one screw (callout 1).

Figure 1-30 Remove the feed assembly (1 of 2)



2. Remove the feed assembly.


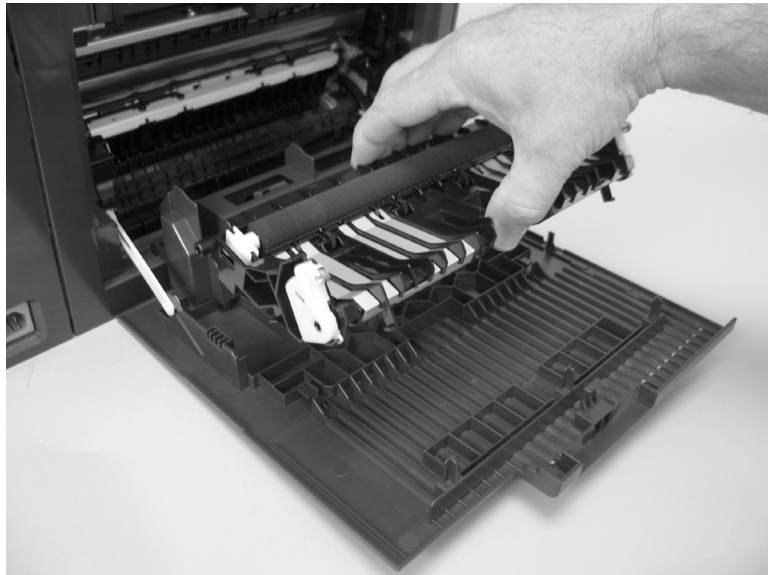
 **TIP:** When the feed assembly is correctly reinstalled, the assembly will be able to move in relation to the door. It should not be secured firmly to the door.

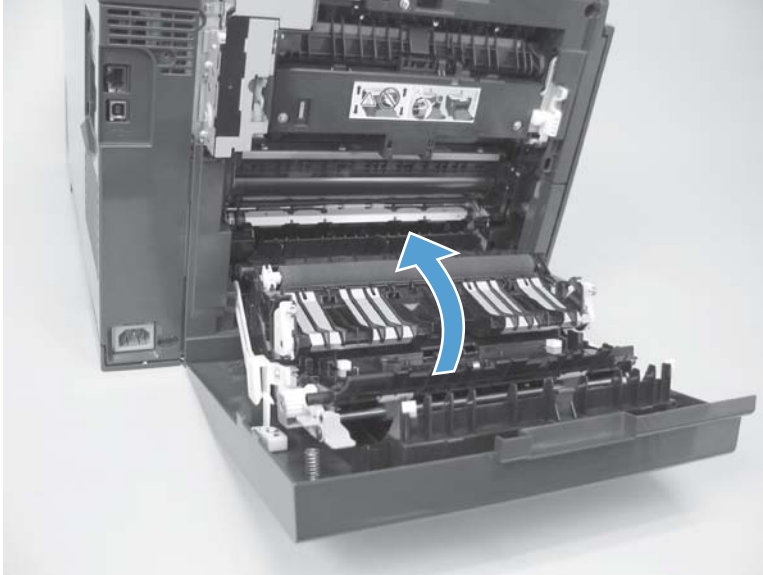
Figure 1-31 Remove the feed assembly (2 of 2)



Rear door

1. Open the rear door.
2. Use the green handle to close the duplex-feed assembly.

Figure 1-32 Close the duplex-feed assembly



3. Remove two screws (callout 1).


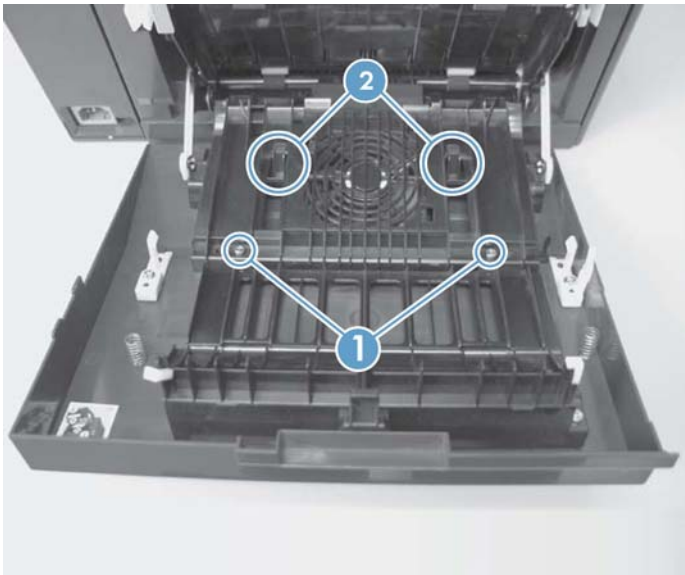
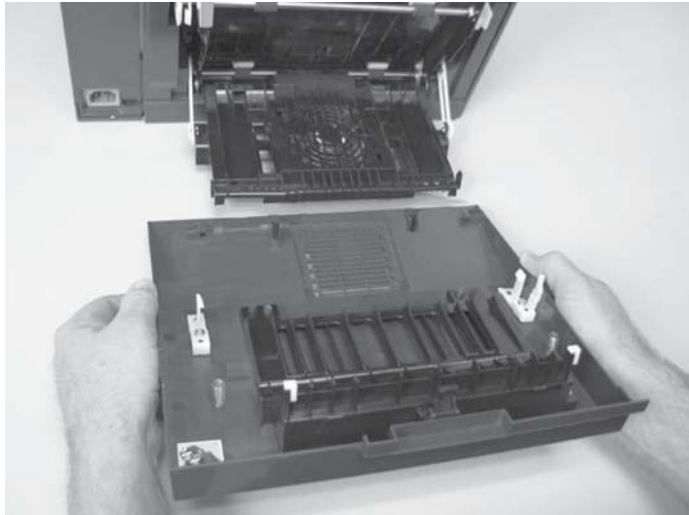
 **NOTE:** Before you remove the rear door, take note of the mounting tabs on the door (callout 2).

Figure 1-33 Remove two screws



4. Slide the door away from the product to release two tabs, and then remove the door.

Figure 1-34 Remove the rear door



Rear-lower cover and rear-door links

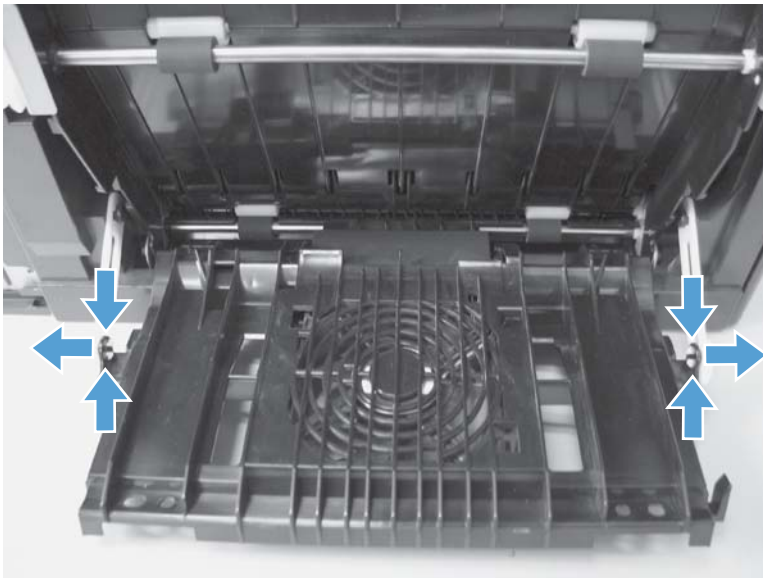
Before proceeding, remove the following components:

- Right cover. See [Right cover on page 25](#).
- Rear door. See [Rear door on page 30](#).
- Rear upper cover. See [Rear-upper cover on page 28](#).

Remove the rear-lower cover and rear-door links

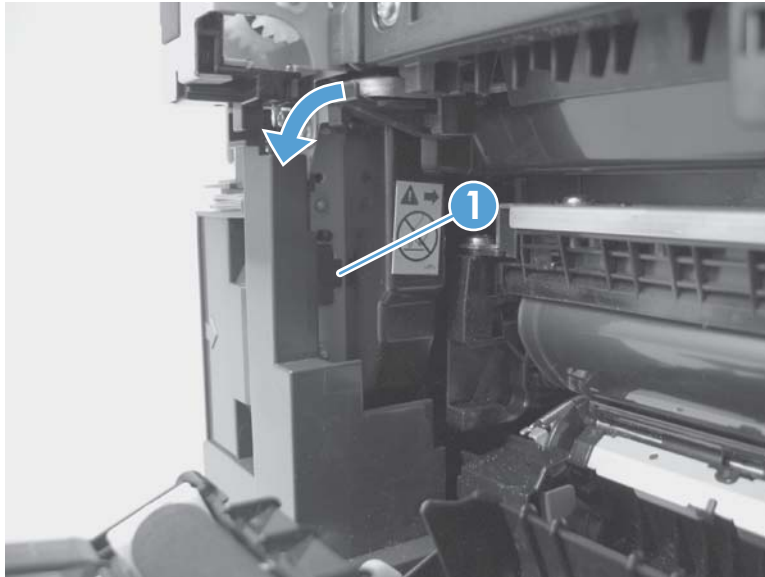
1. Use a pair of needle-nose pliers to release two tabs, and then remove the rear-door link cap. Repeat this step for the remaining rear-door link cap.

Figure 1-35 Remove the rear-lower cover and rear-door links (1 of 6)



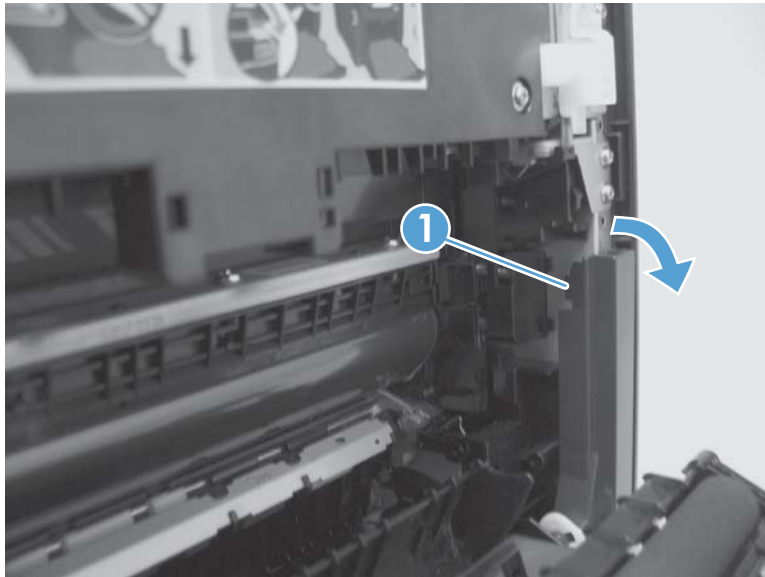
2. Open the duplex-feed assembly, release one tab (callout 1), and then slightly separate the cover from the product.

Figure 1-36 Remove the rear-lower cover and rear-door links (2 of 6)



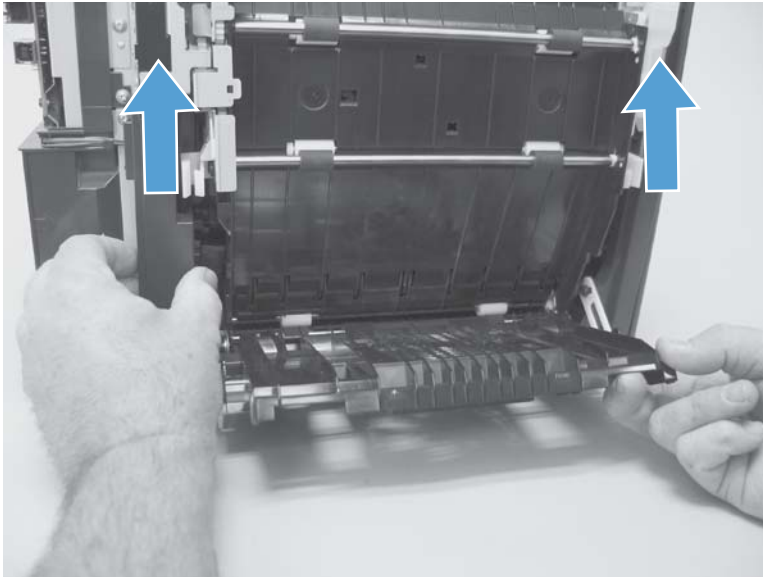
3. Release one tab (callout 1) and slightly separate the cover from the product.

Figure 1-37 Remove the rear-lower cover and rear-door links (3 of 6)



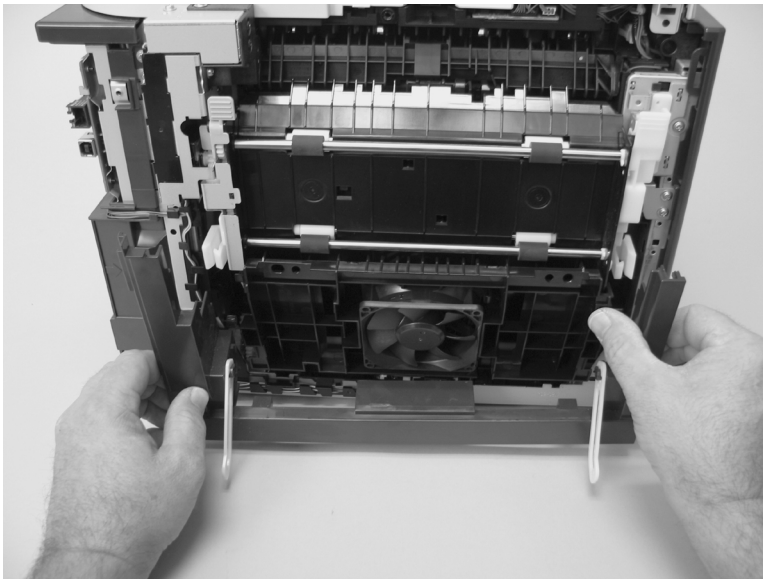
4. Close the duplex assembly, and then lift up on one side of the cover, and then the other side of the cover to release it.

Figure 1-38 Remove the rear-lower cover and link-guides (4 of 6)



5. Slightly lift up the rear-door rib assembly, and then carefully slide the cover away from the product to remove it.

Figure 1-39 Remove the rear-lower cover and link-guides (5 of 6)



6. Rotate the rear-door link until the slot in the link aligns with the tap on the link-hinge pin, and then remove the rear-door link. Repeat this step for the remaining rear-door link.


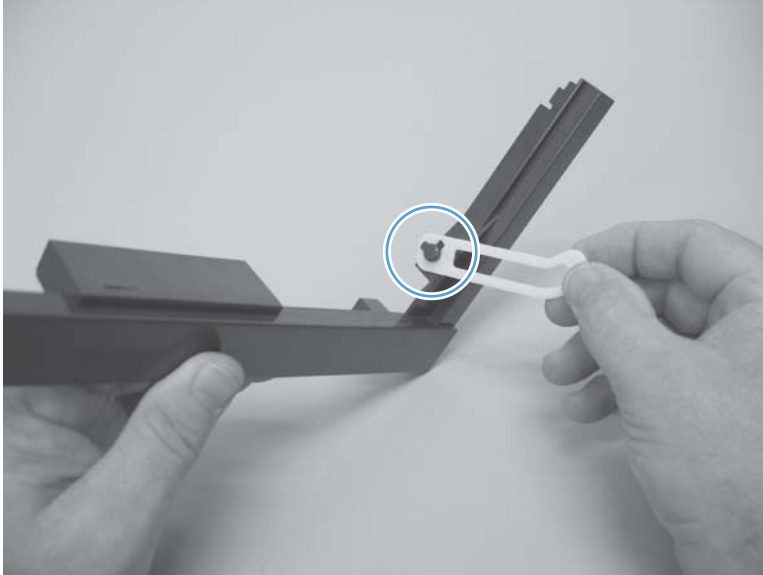
 **NOTE:** If you are installing a replacement rear-lower cover, remove the rear-door links from the discarded cover, and then install them on the replacement cover.

Figure 1-40 Remove the rear-lower cover and rear-door links (6 of 6)



Rear-door rib assembly

Before proceeding, remove the following components:

- Right cover. See [Right cover on page 25](#).
- Rear door. See [Rear door on page 30](#).
- Rear upper cover. See [Rear-upper cover on page 28](#).
- Rear-lower cover. See [Rear-lower cover and rear-door links on page 32](#).

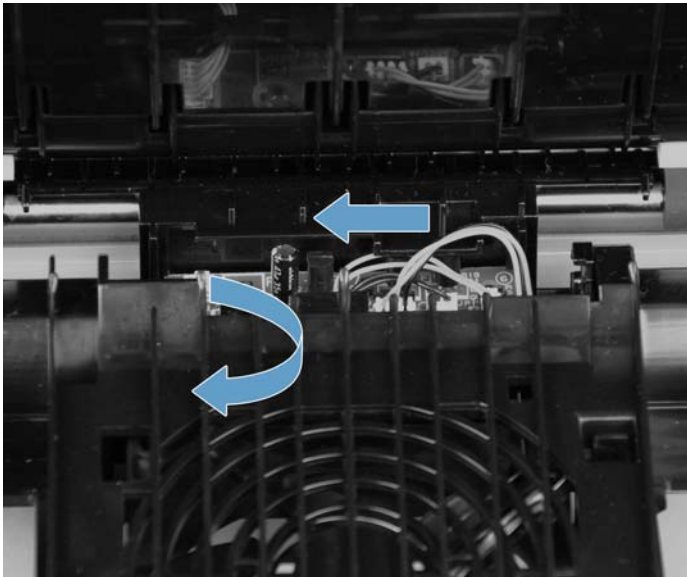
Remove the rear-door rib assembly



NOTE: The duplex fan (FM2) is a component of the rear-door rib assembly.

1. Slide the rear rib assembly to the left, lift the door gently, and then rotate it away from the product slightly.

Figure 1-41 Remove the rear-door rib assembly (1 of 3)



2. Slide the PCA loose, then remove the third connector from the right with red, yellow, and black wires.


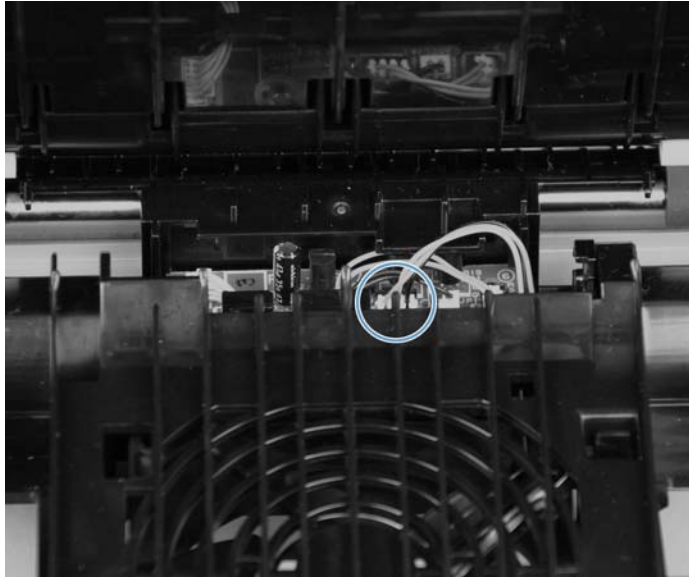
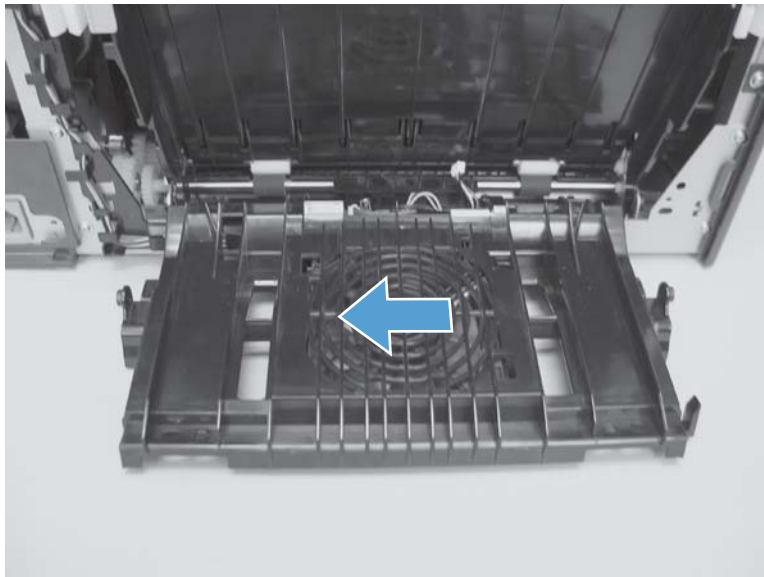
 **TIP:** The PCA can be dislodged when disconnecting the connector. To secure the PCA, carefully push it towards the inside of the product to clear the mounting tabs near the rib assembly (callout 2 shows the PCA correctly positioned under the tabs). Slide the PCA towards the rib assembly to position the edge of the PCA under the mounting tabs.

Figure 1-42 Remove the rear-door rib assembly (2 of 3)



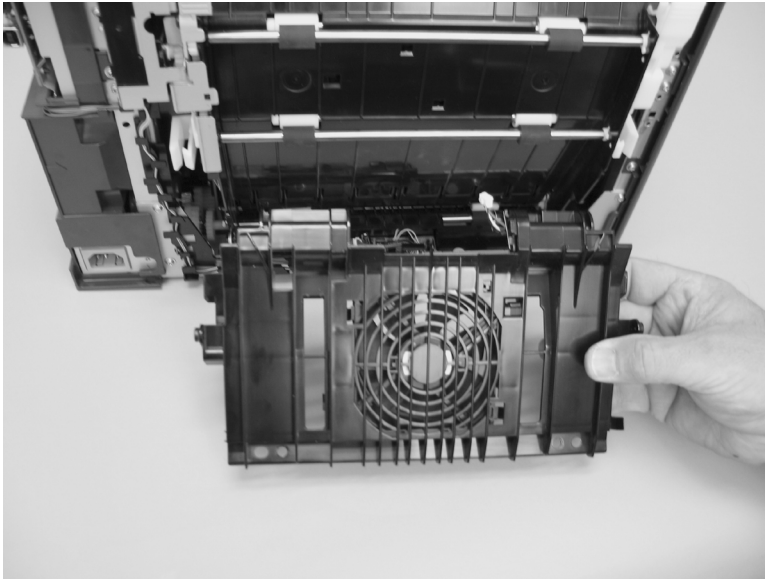
3. Slide the assembly toward the power cable side of the product to release the hinge pin.

Figure 1-43 Remove the rear-door rib assembly (2 of 3)



4. Remove the assembly.

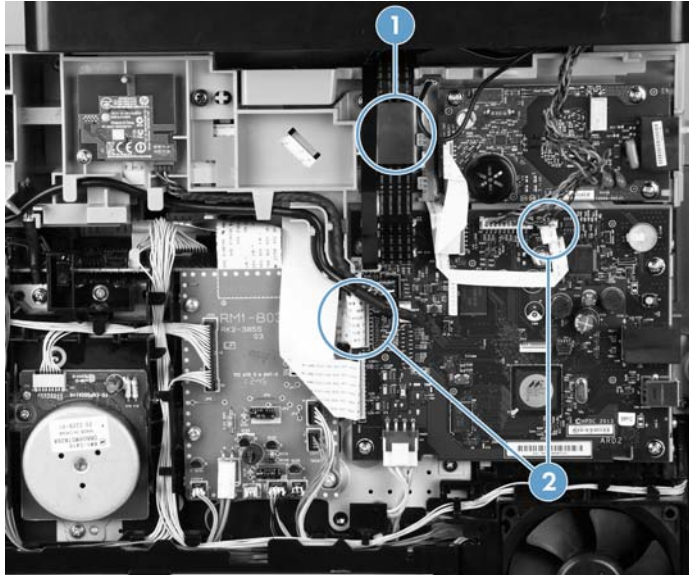
Figure 1-44 Remove the rear-door rib assembly (3 of 3)



Control panel and right-arm mount

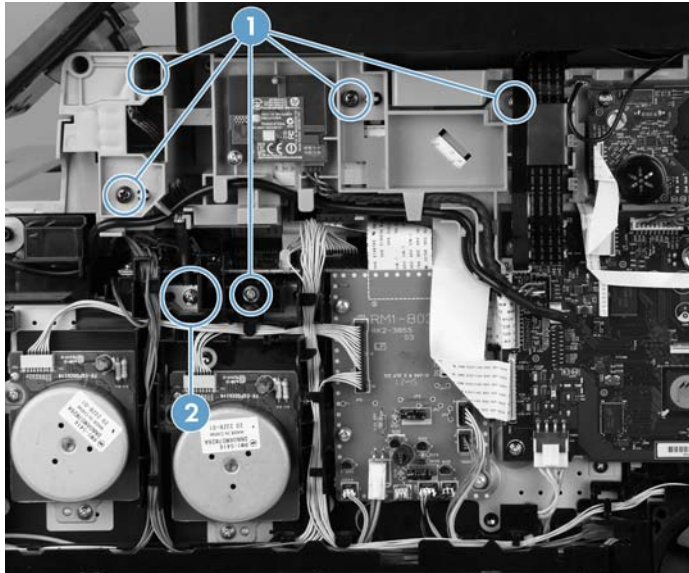
1. Remove the Right cover. See [Right cover on page 25](#).
2. Remove the wireless PCA.
3. Disconnect two FFCs (callout 2) and two connectors, detach the USB PCA connector in the retainer, then loosen the ferrite from the control panel mount (callout 1).

Figure 1-45 Disconnect FFCs and connectors and loosen ferrite



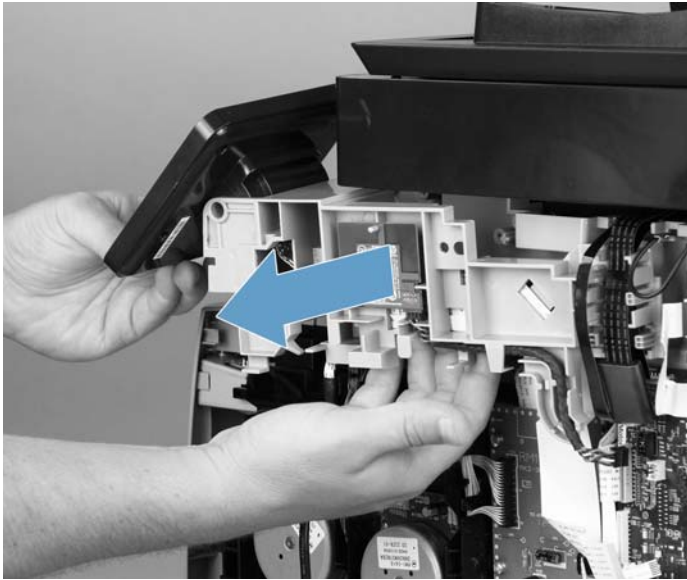
4. Remove four screws (callout 1) and disconnect the ground wire (callout 2).

Figure 1-46 Remove four screws and disconnect the ground wire



5. Slide the control panel right-arm mount to the right to remove it from the scanner chassis.

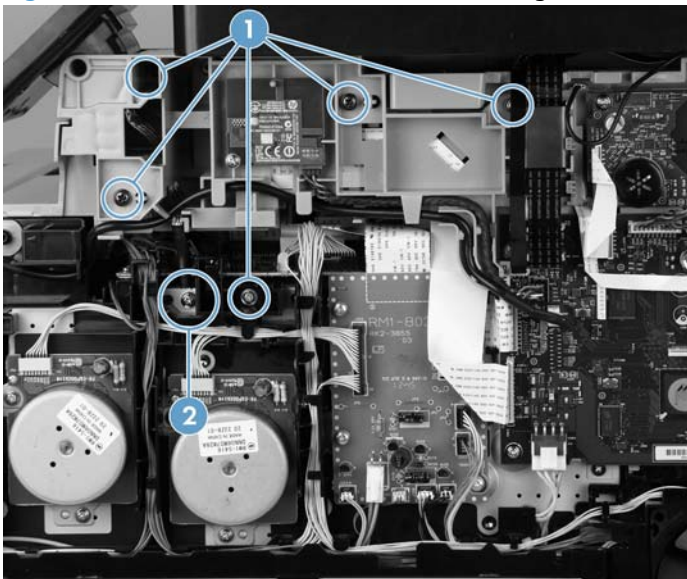
Figure 1-47 Remove the right-arm mount



Reinstall the control panel and right-arm mount

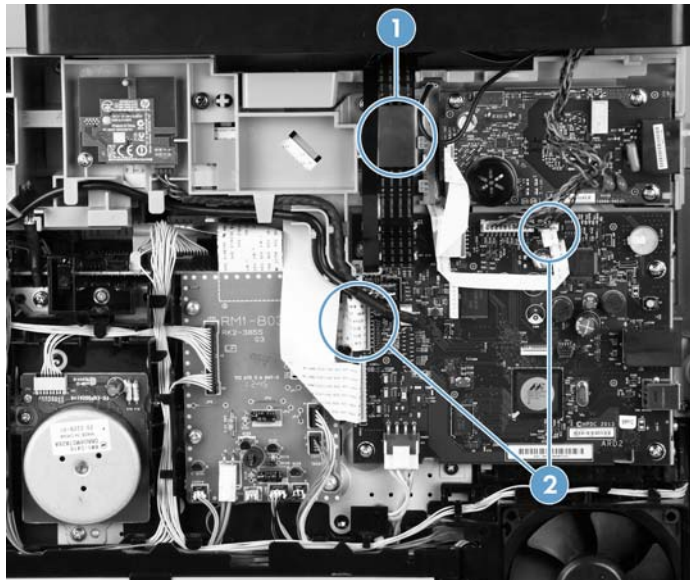
1. Install the wireless card into the new control panel.
2. Slide the control panel right-arm mount assembly into the mounting points on the scanner chassis.
3. Install four screws (callout 1) and attach the grounding wire (callout 2).

Figure 1-48 Install four screws and connect the ground wire



4. Replace two FFCs (callout 2), two connectors, and the PCA connector, then replace the ferrite (callout 1).

Figure 1-49 Connect FFCs and connectors and replace ferrite



Upper-cover assembly

Before proceeding, remove the following components:

- Right cover. See [Right cover on page 25](#).
- Scanner assembly. See [Scanner assembly on page 17](#).
- Rear upper cover. See [Rear-upper cover on page 28](#).
- Control panel and right-arm mount. See [Control panel and right-arm mount on page 39](#).
- Right-front cover and power button. See [Right-front cover and power button on page 26](#).

Remove the upper-cover assembly

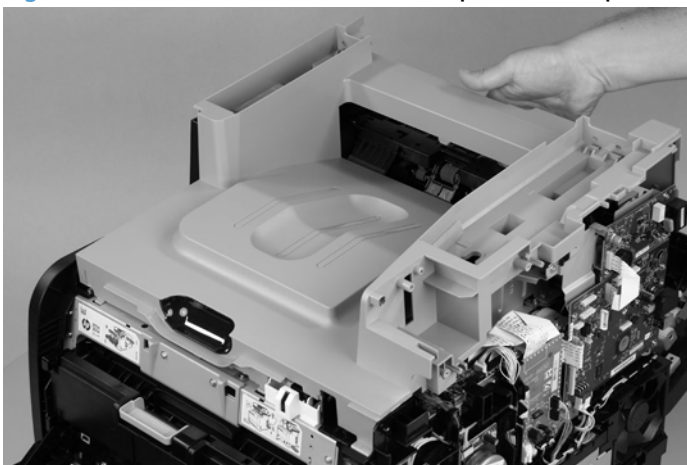
1. Remove four screws (callout 1).

Figure 1-50 Remove four screws



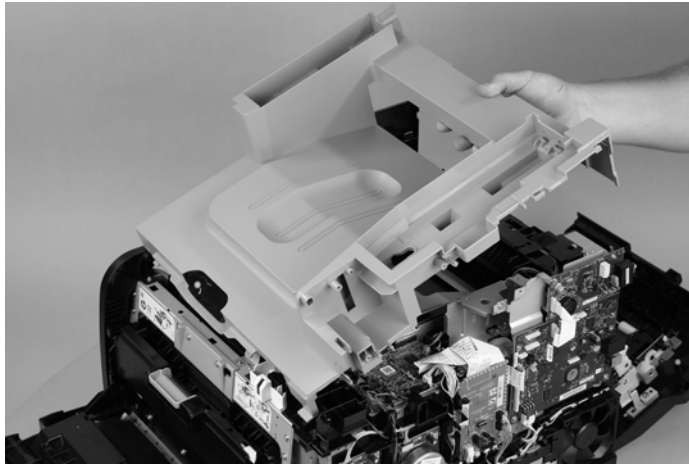
2. Slightly raise the back of the cover up and off of the product.

Figure 1-51 Raise the back of the cover up and off the product



3. Slide the cover toward the back of the product to remove it.

Figure 1-52 Remove the upper-cover assembly



Reinstall the upper-cover assembly

1. Position the upper-cover so that the front-left corner of the upper cover engages the left-side cover (callout 1).

Figure 1-53 Reinstall the upper-cover assembly (1 of 3)



2. Slightly push the cover toward the front of the product to engage the front-locking tabs (callout 1) with the holes in the chassis.


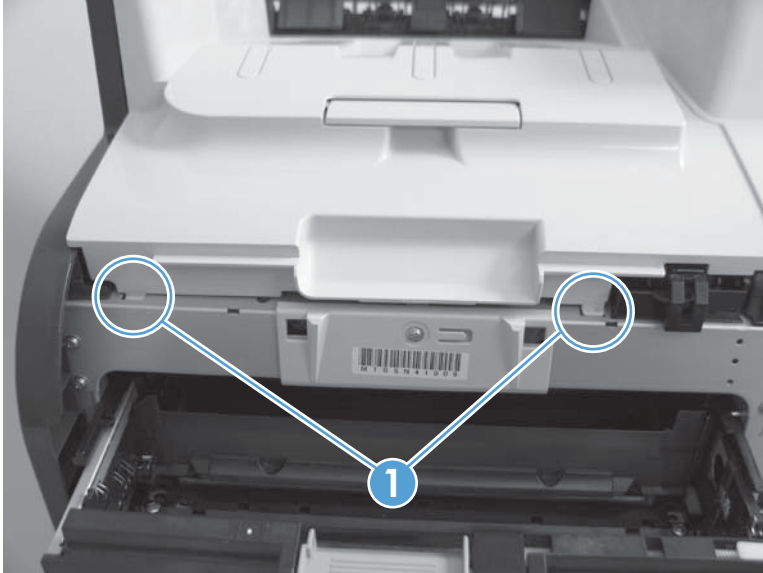
 **NOTE:** Make sure that the right-front edge of the upper cover (where the product right-front cover will be installed) is correctly positioned on the chassis.

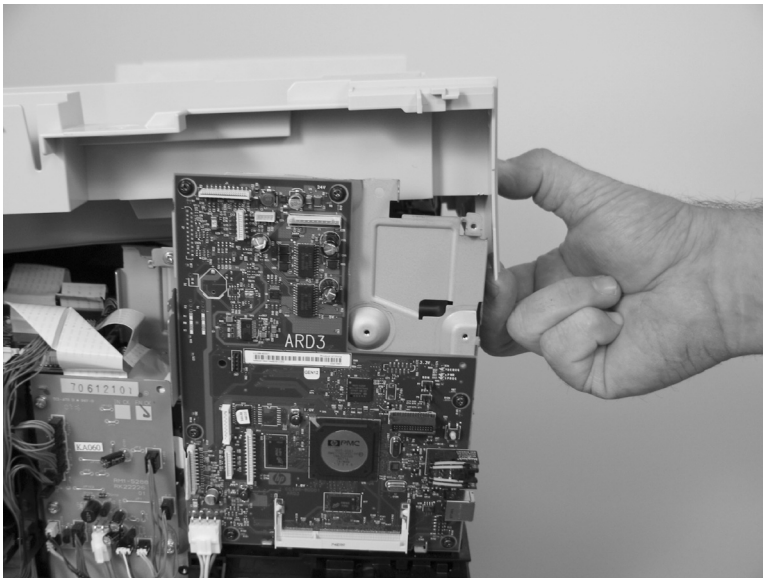
Figure 1-54 Reinstall the upper-cover assembly (2 of 3)



3. Carefully pry the right-rear corner of the upper cover away from the product until the cover fits over the chassis.

Lower the cover onto the product.

Figure 1-55 Reinstall the upper-cover assembly (3 of 3)



Left cover

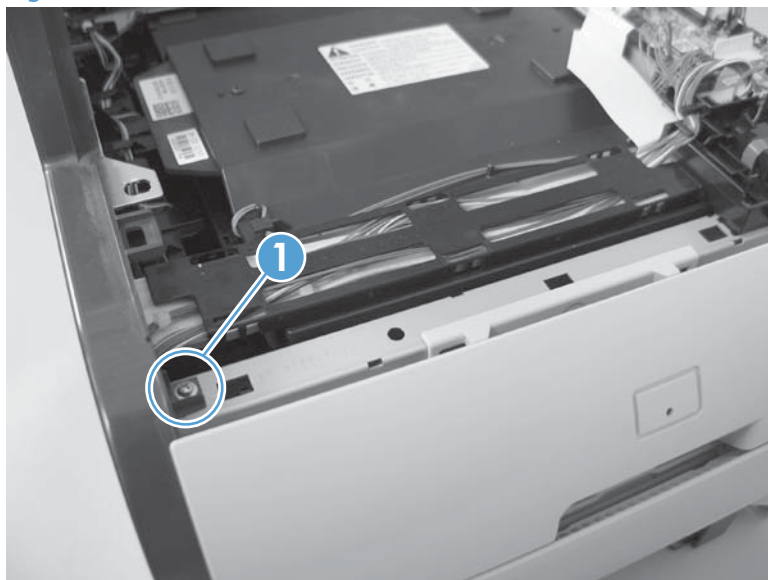
Before proceeding, remove the following components:

- Right cover. See [Right cover on page 25](#).
- Scanner assembly. See [Scanner assembly on page 17](#).
- Rear-lower cover. See [Rear-lower cover and rear-door links on page 32](#).
- Upper-cover assembly. See [Upper-cover assembly on page 42](#).

Remove the left cover

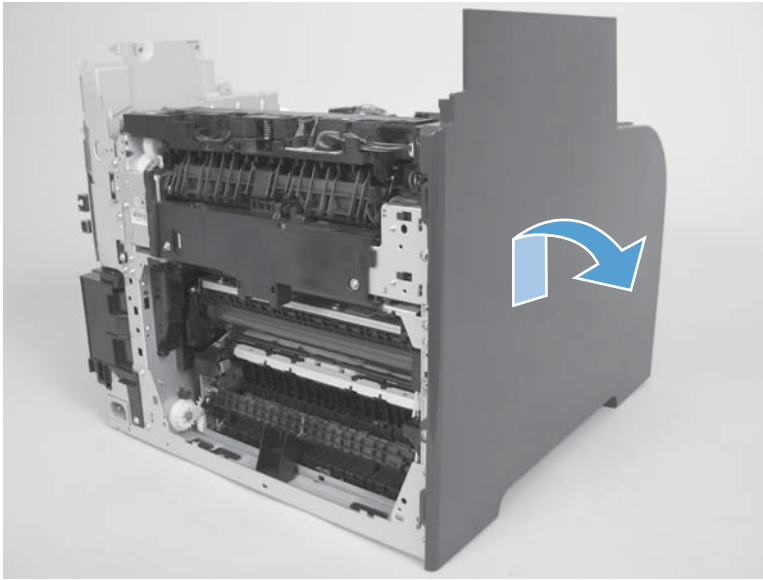
1. Remove one screw (callout 1).

Figure 1-56 Remove the left cover (1 of 3)



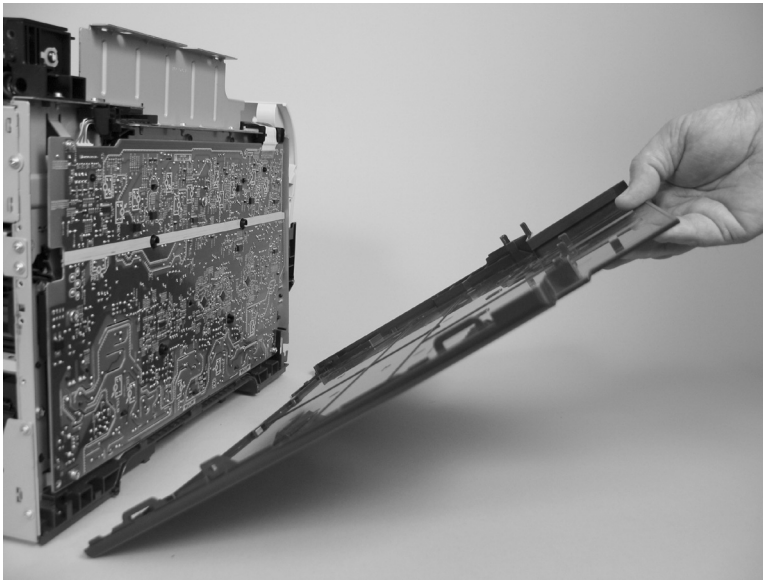
2. Slightly lift up on the cover, and then rotate the top of the cover away from the product.

Figure 1-57 Remove the left cover (2 of 3)



3. Remove the cover.

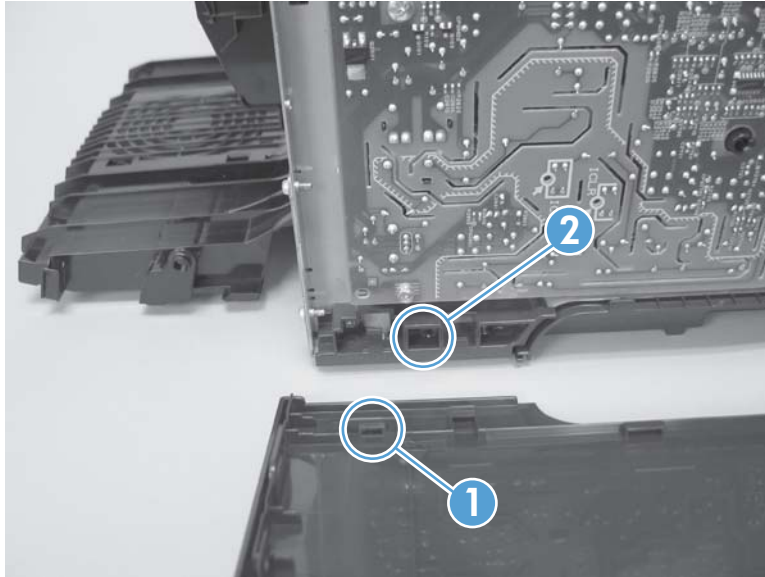
Figure 1-58 Remove the left cover (3 of 3)



Reinstall the left cover

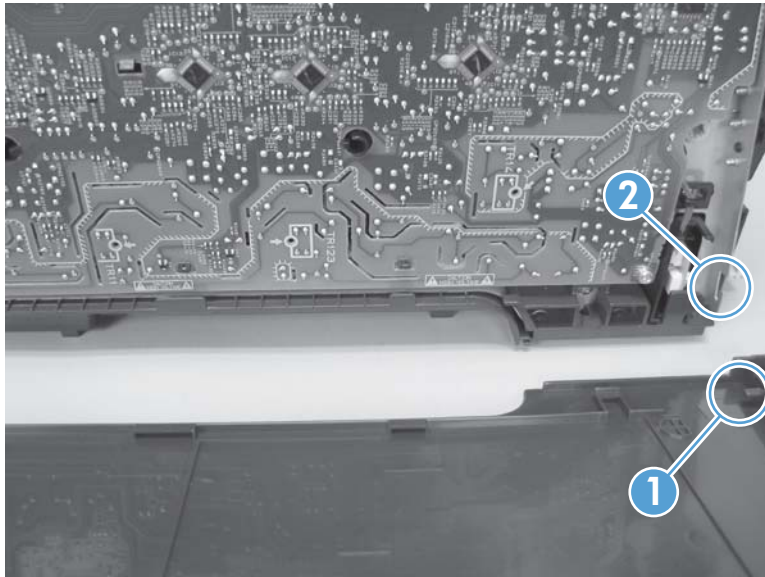
1. When you reinstall the left cover, make sure that the slot in the cover (callout 1) aligns with the tab (callout 2) on the product.

Figure 1-59 Reinstall the left cover (1 of 2)



2. When you reinstall the left cover, make sure that the pin on the cover (callout 1) aligns with the slot (callout 2) in the product.

Figure 1-60 Reinstall the left cover (2 of 2)



Front-door assembly

Before proceeding, remove the following components:

- Print-cartridge drawer. See [Print-cartridge drawer on page 22](#).
- Right cover. See [Right cover on page 25](#).
- Scanner assembly. See [Scanner assembly on page 17](#).
- Rear-upper cover. See [Rear-upper cover on page 28](#).
- Rear door. See [Rear door on page 30](#).
- Rear-lower cover. See [Rear-lower cover and rear-door links on page 32](#).
- Upper-cover assembly. See [Upper-cover assembly on page 42](#).
- Left cover. See [Left cover on page 45](#).
- Right-front cover. See [Right-front cover and power button on page 26](#).

Remove the front-door assembly

1. Locate the front-door pin on the left-side door link.

Figure 1-61 Remove the front-door assembly (1 of 10)



2. Use a precision point (flat head) screwdriver to push the left-side metallic door pin out of the link.


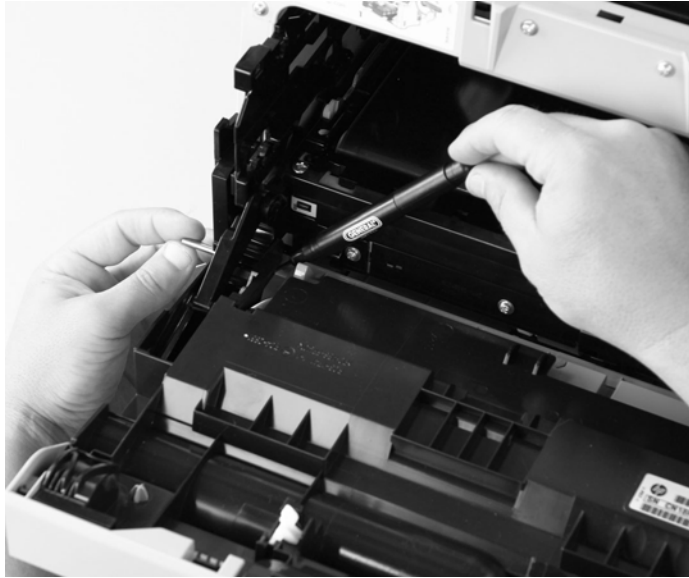
 **NOTE:** A precision point screwdriver is required to release the front door pins. The width of the blade must be 2 mm (0.08 in) or less to be able to push the door pins out of the mounting holes.

Figure 1-62 Remove the front-door assembly (2 of 10)



3. Use a precision point (flat head) screwdriver to push the right-side metallic door pin out of the link.


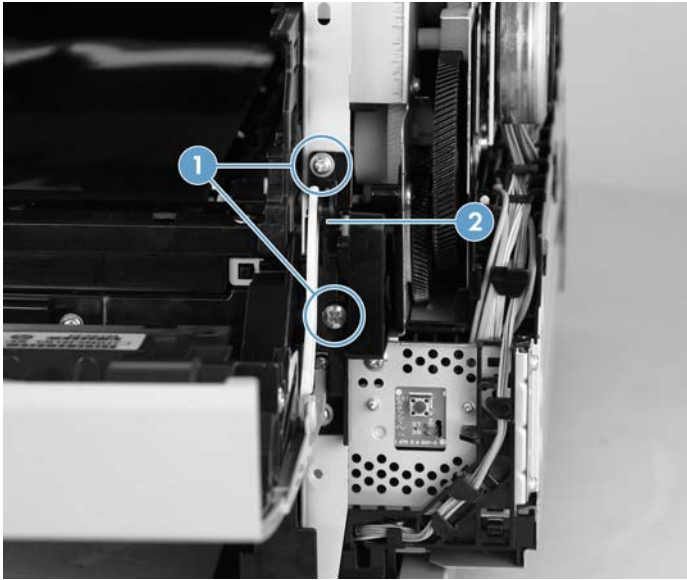
 **NOTE:** A precision point screwdriver is required to release the front door pins. The width of the blade must be 2 mm (0.08 in) or less to be able to push the door pins out of the mounting holes.

Figure 1-63 Remove the front-door assembly (3 of 10)



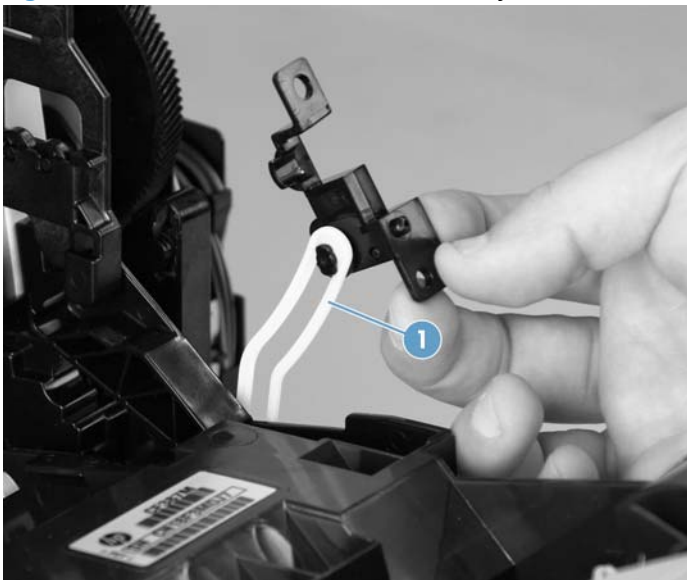
4. Remove two screws (callout 1) and then separate the door bushing (callout 2) from the chassis.

Figure 1-64 Remove the front-door assembly (4 of 10)



5. Release the bushing from the door-retainer link (callout 1).

Figure 1-65 Remove the front-door assembly (5 of 10)



6. Support the door assembly, and carefully release the pin on the right-side link.

Figure 1-66 Remove the front-door assembly (6 of 10)



7. Support the door assembly, and carefully release the upper pin on the left-side link.

Figure 1-67 Remove the front-door assembly (7 of 10)



8. Push the black-plastic arm into the product.

Figure 1-68 Remove the front-door assembly (8 of 10)



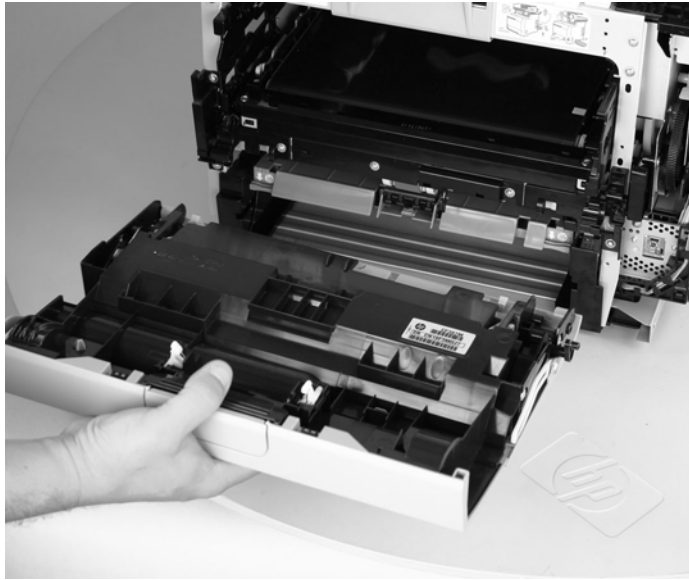
9. Support the door assembly, and carefully release the lower pin on the left-side link.

Figure 1-69 Remove the front-door assembly (9 of 10)



10. Remove the front-door assembly.

Figure 1-70 Remove the front-door assembly (10 of 10)



Internal assemblies

Intermediate transfer belt (ITB)

1. Remove the print-cartridge drawer. See [Print-cartridge drawer on page 22](#).
2. Open the front door, and then remove two screws (callout 1).

Figure 1-71 Remove the ITB (1 of 6)



3. Carefully rotate the color-misregistration sensor away from the ITB.

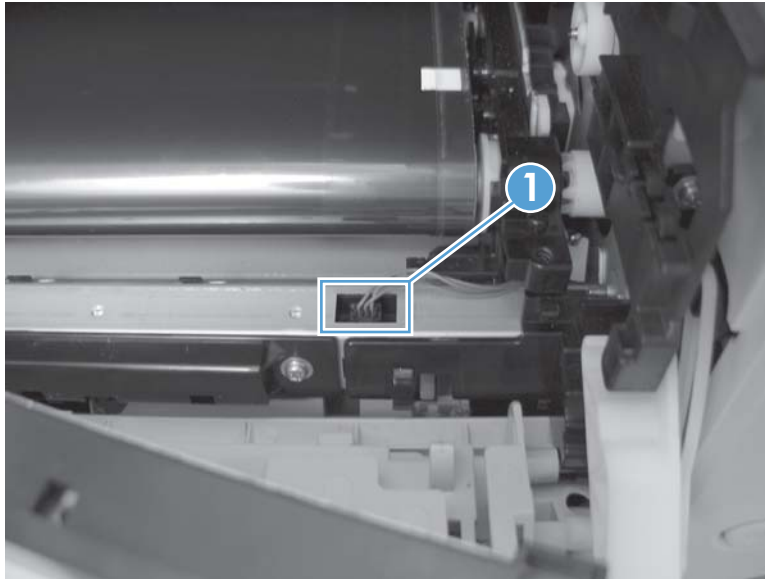
CAUTION: The sensor is still attached to the product and cannot be completely removed.

Figure 1-72 Remove the ITB (2 of 6)



4. Disconnect one connector (callout 1).

Figure 1-73 Remove the ITB (3 of 6)



5. Carefully lift up on the front of the ITB to release it.

CAUTION: Wear gloves when handling the ITB, and avoid touching the black plastic transfer belt. Skin oils on the belt might cause print-quality problems. Lift the ITB as shown below, by using the hard-plastic edges of the ITB.

Figure 1-74 Remove the ITB (4 of 6)

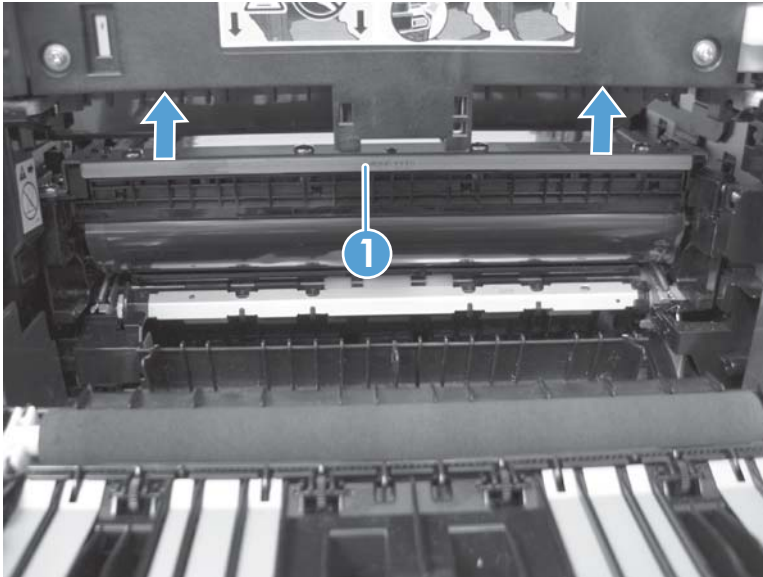


6. Open the rear door, and carefully lift up on the sheet-metal portion (callout 1) of the ITB to release it.

CAUTION: Avoid touching the black plastic transfer belt. Skin oils on the belt might cause print-quality problems.

NOTE: You might need to reach in through the front door and support the front portion of the ITB to keep it from falling back into place as you perform this step.

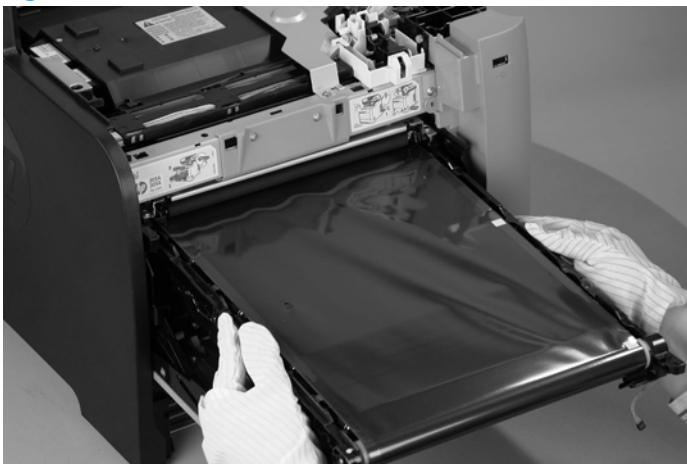
Figure 1-75 Remove the ITB (5 of 6)



7. Carefully pull the ITB straight out of the product to remove it.

CAUTION: Wear gloves when handling the ITB, and avoid touching the black plastic transfer belt. Skin oils on the belt might cause print-quality problems. Handle the ITB as shown below.

Figure 1-76 Remove the ITB (6 of 6)



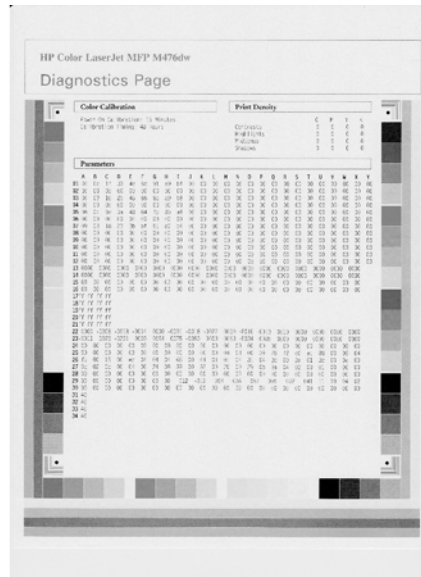
Reinstall the ITB

Use this procedure to reinstall the ITB and then verify that the ITB is correctly reinstalled.

1. Press the ITB back on the springs to fully seat it into position. To seat the ITB correctly, push in the spring-loaded gear on the engine side.
2. Use the control panel to print the diagnostics pages.
3. Verify that rows **one** through **four**, columns **A** through **I** (callout 1) contain hexadecimal numbers.

If these rows and columns are all zero, ensure that the calibration sensor was correctly reinstalled. The sensor must be correctly positioned and fit securely against the chassis before the mounting screws are installed. See [1](#) and [2](#).

Figure 1-77 Diagnostic page



Drum motor (M1) and developer motor (M2)

This procedure can be used to remove the drum motor (M1) or the developer motor (M2). HP does not recommend removing both of the motors at the same time.

1. Remove the right cover. See [Right cover on page 25](#).
2. Disconnect one connector (callout 1) for motor M1 or motor M2.


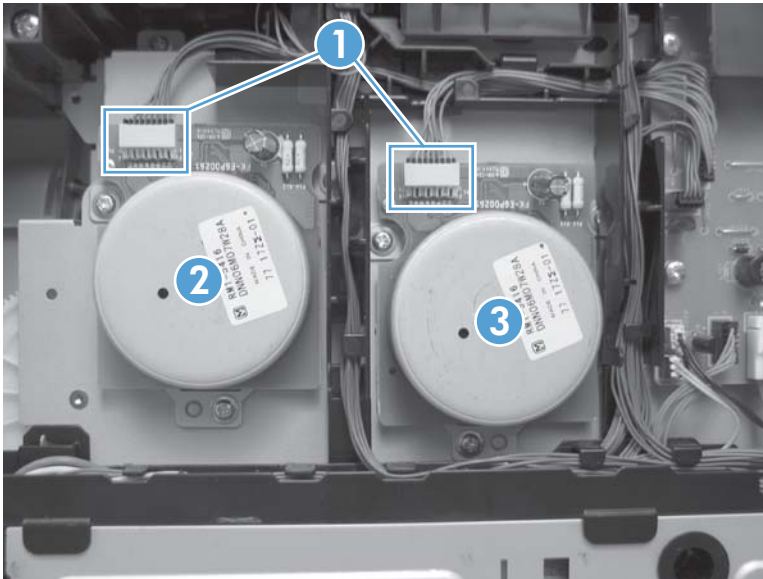
 **NOTE:** The drum motor (callout 2) is motor M1. The developer motor (callout 3) is motor M2.

Figure 1-78 Remove motor M1 and motor M2 (1 of 6)



3. Remove one screw (callout 1), and then remove the black-plastic retainer (callout 2).


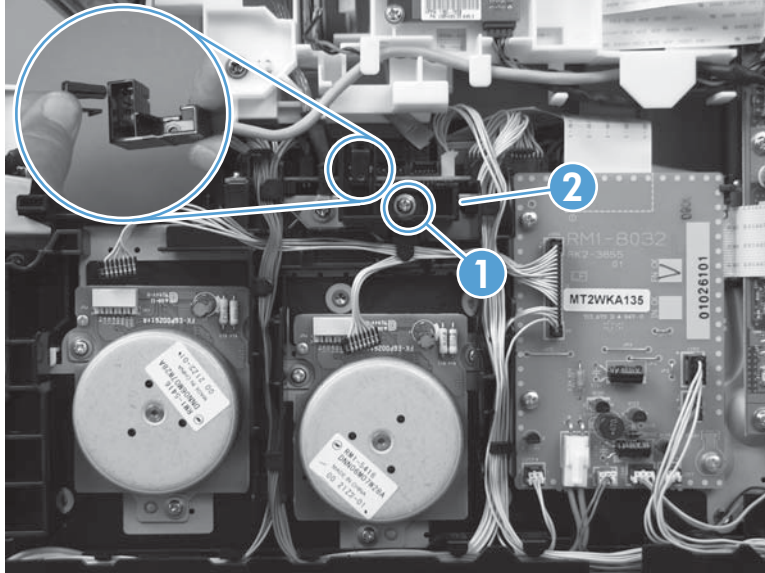

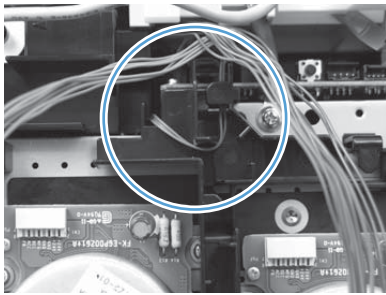
 **NOTE:** There is a small clip—the clip is used to activate the engine test button—attached to the retainer that can be easily dislodged when the retainer is removed. Do not lose this clip when handling the retainer.

Figure 1-79 Remove motor M1 and motor M2 (2 of 6)



4. Release the wire harnesses from the retainer (callout 1).

 **NOTE:** One of the wire harnesses—behind the drum motor wire harness—is difficult to release from the retainer. Be careful to not damage this wire harness when releasing it.




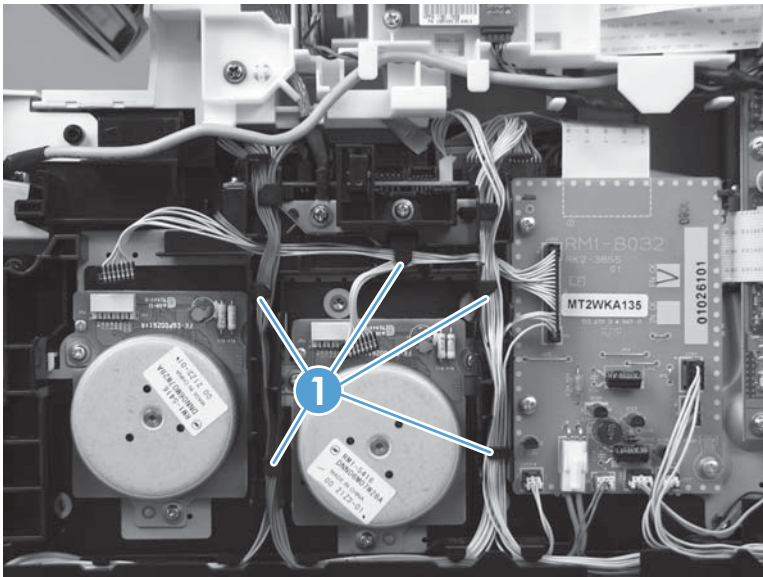
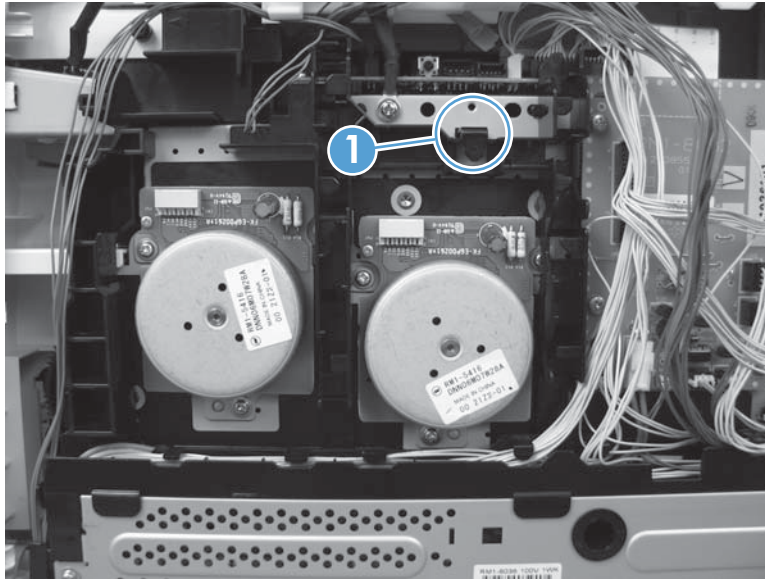
 **TIP:** Additional connectors might need to be disconnected to release the wire harnesses from the retainer.

Figure 1-80 Remove motor M1 and motor M2 (3 of 6)



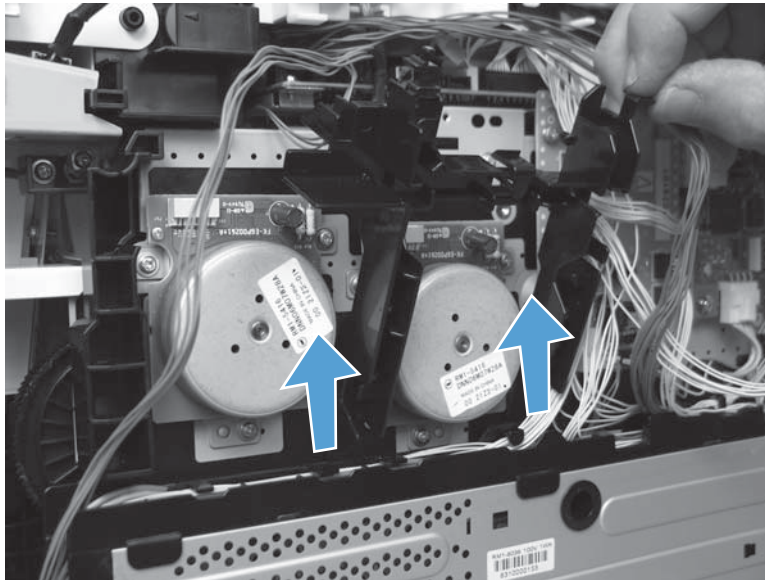
5. Release one tab (callout 1).

Figure 1-81 Remove motor M1 and motor M2 (4 of 6)



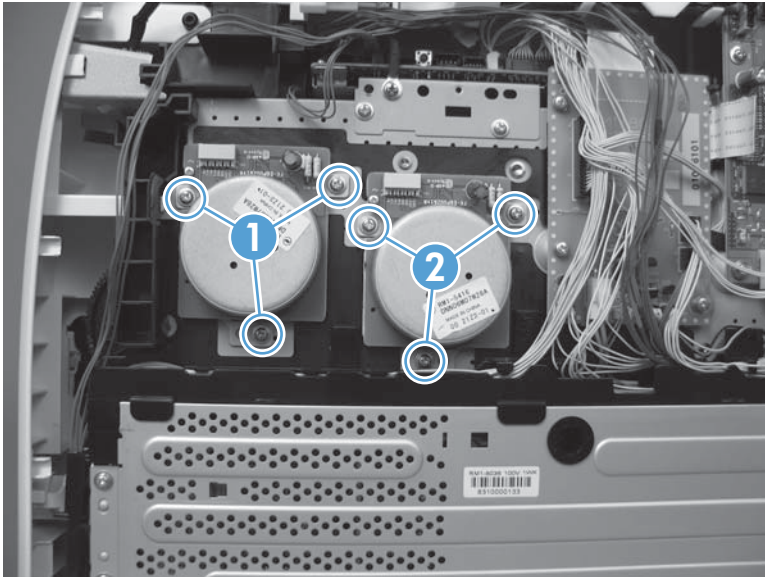
6. Rotate the top of the retainer away from the chassis, and then lift it up to remove it.

Figure 1-82 Remove motor M1 and motor M2 (5 of 6)



7. Remove three screws (callout 1) to remove motor M1, or remove three screws (callout 2) to remove motor M2.

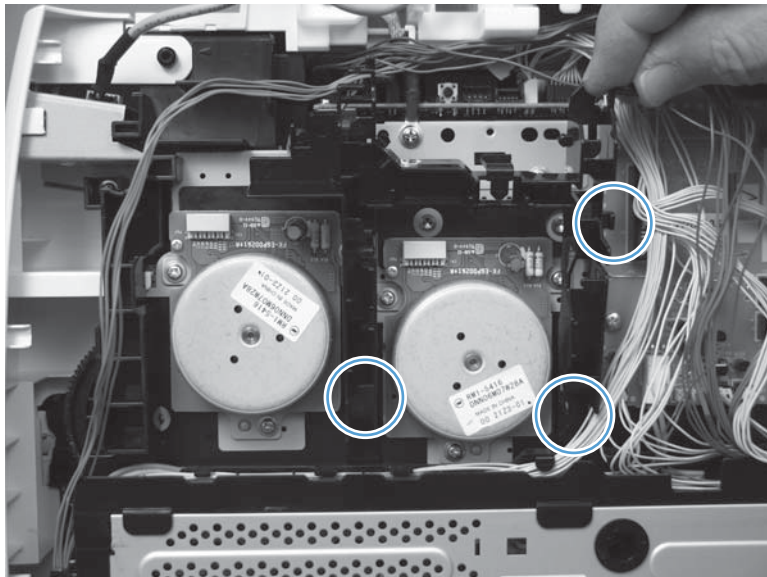
Figure 1-83 Remove motor M1 and motor M2 (6 of 6)



Reinstall the drum motor (M1) and developer motor (M2)

When the motor wire harness retainer is reinstalled, the two tabs at the bottom of the retainer must be positioned behind the retainer on the low-voltage power supply. The tab at the side of motor wire harness retainer must be positioned behind the PCA next to motor M2.

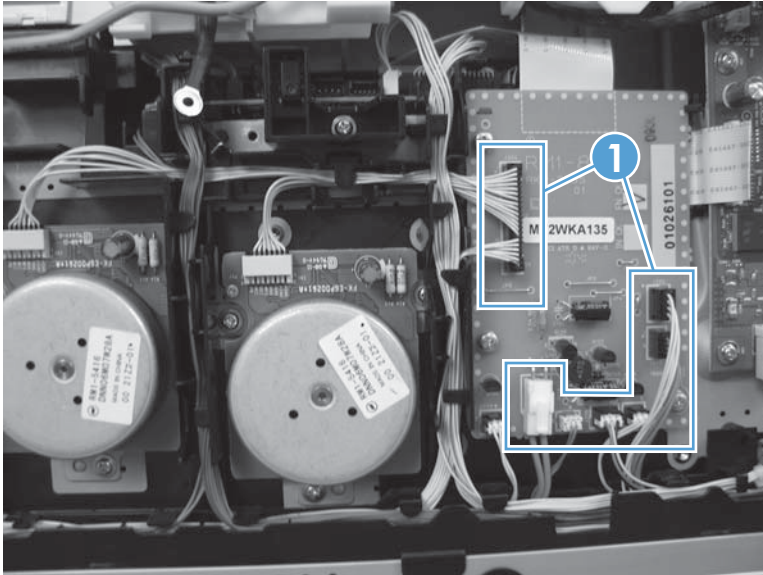
Figure 1-84 Reinstall the motor M1 and motor M2 wire-harness retainer



Intermediate PCA

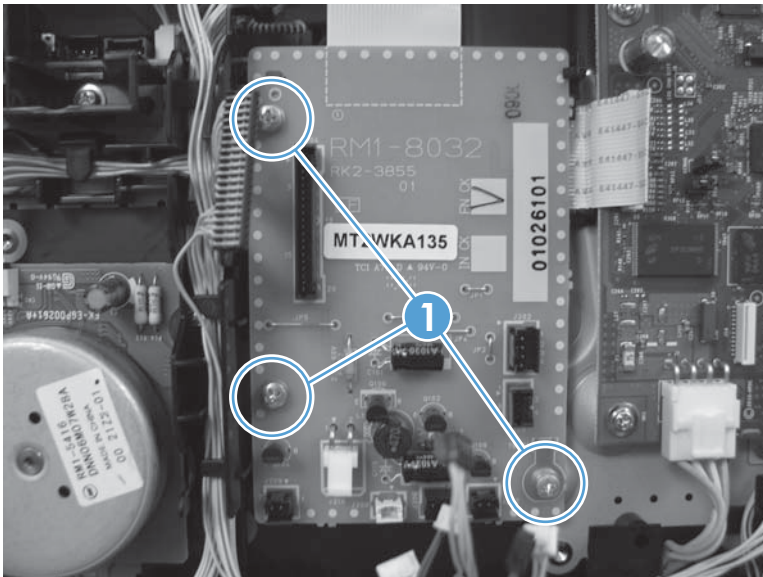
1. Remove the right cover. See [Right cover on page 25](#).
2. Disconnect all of the connectors and one FFC (callout 1) on the PCA.

Figure 1-85 Remove the Intermediate PCA (1 of 2)



3. Remove three screws (callout 1), and then remove the intermediate PCA.

Figure 1-86 Remove the Intermediate PCA (2 of 2)




Formatter PCA

 **WARNING!** Do not install a *replacement* formatter PCA and DC controller PCA at the same time.

The formatter PCA and the DC controller PCA store important product configuration information (NVRAM data) that is lost if both PCAs are replaced at the same time. When the product power is turned on, the DC controller restores the NVRAM data on the replacement formatter.

Replacing both the formatter and the DC controller at the same time will result in severe print-quality problems.


 **NOTE:** The base model does not have a fax card installed.

Replacing the formatter PCA before the DC controller PCA

Use the following procedure if you need to install a replacement formatter PCA *and* a replacement DC controller.


 **NOTE:** If you are only installing a replacement formatter PCA, go to [Remove the formatter PCA on page 65](#).


1. Install a replacement formatter PCA.
2. Turn the product on, and wait for the print-cartridge volume indicators to appear on the control-panel display.


 **NOTE:** This allows important product information to be written to the replacement formatter PCA.

3. Turn the product off.
4. Install a replacement DC controller. See [DC controller PCA on page 69](#).
5. Turn the product on.

Remove the formatter PCA

 **CAUTION:** Do not bend or fold the flat flexible cables (FFCs) during removal or installation. Also, do not straighten pre-folds in the FFCs. You *must* make sure that all FFCs are fully seated in their connectors. Failure to fully seat an FFC into a connector can cause a short circuit in a PCA.

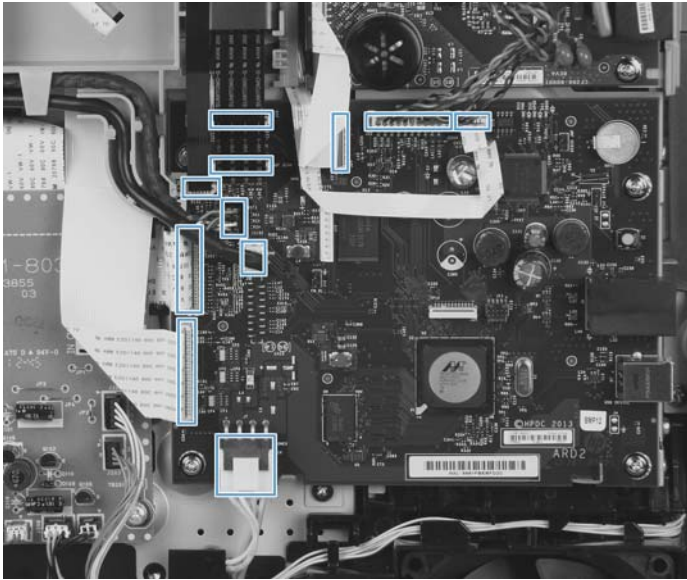
 Some parts are sensitive to electrostatic discharge (ESD). Always perform service work at an ESD-protected workstation or mat. If an ESD workstation or mat is not available, ground yourself by touching the sheet-metal chassis *before* touching an ESD-sensitive part.

 **NOTE:** The base model does not have a fax PCA.

1. Remove the right cover. See [Right cover on page 25](#).

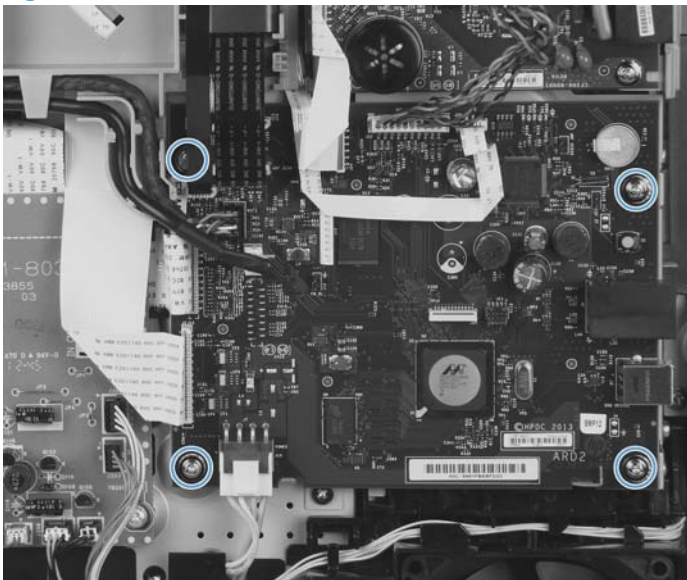
2. Disconnect 11 connectors.

Figure 1-87 Remove the formatter PCA (1 of 2)



3. Remove four screws, and then remove the formatter PCA.

Figure 1-88 Remove the formatter PCA (2 of 2)



Fax PCA

1. Remove the right cover. See [Right cover on page 25](#)

2. Remove four screws (callout 1) and one connector (callout 2).


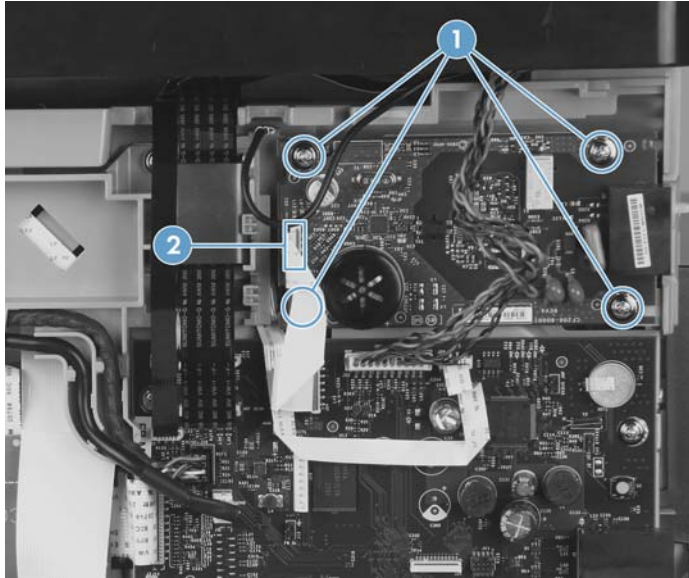
 **NOTE:** The base model does not have a fax PCA.

Figure 1-89 Remove the fax PCA

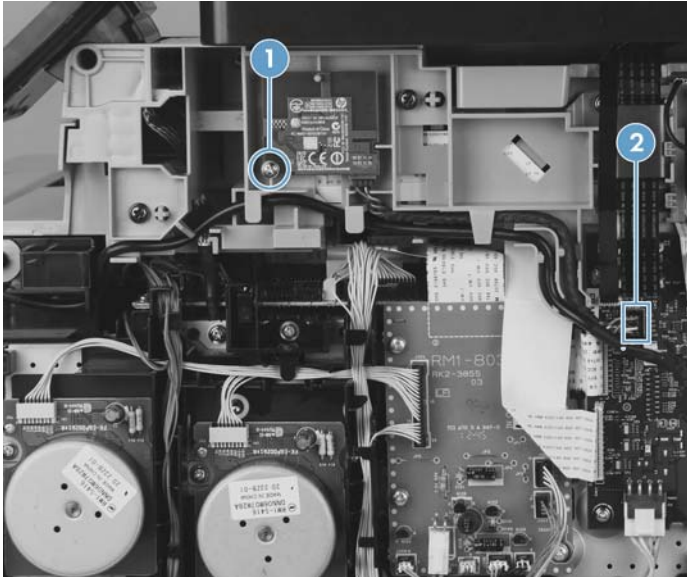


3. Remove the fax PCA.

Wireless PCA

1. Remove the right cover. See [Right cover on page 25](#)
2. Remove one screw (callout 1). Disconnect one connector (callout 2) at the formatter PCA.

Figure 1-90 Remove the wireless PCA



3. Remove the wireless PCA.

DC controller PCA

 **WARNING!** Do not install a *replacement* formatter PCA and a *replacement* DC controller PCA at the same time.


The formatter PCA and the DC controller PCA store important product configuration information (NVRAM data) that is lost if both PCAs are replaced at the same time. When the product power is turned on, the formatter restores the NVRAM data to a replacement DC controller.

Replacing both the DC controller and the formatter at the same time will result in severe print-quality problems.

Replacing the DC controller PCA before the formatter PCA

Use the following procedure if you need to install a replacement DC controller *and* a replacement formatter PCA.

1. Install a replacement DC controller PCA.
2. Turn the product on, and wait for the print-cartridge volume indicators to appear on the control-panel display.


 **NOTE:** This allows important product information to be written to the replacement DC controller PCA.


3. Turn the product off.
4. Install a replacement formatter PCA. See [Formatter PCA on page 65](#).
5. Turn the product on.

Before you proceed, remove the following components:

- Right cover. See [Right cover on page 25](#).
- Scanner assembly. See [Scanner assembly on page 17](#).
- Upper cover. See [Upper-cover assembly on page 42](#).

Remove the DC controller PCA

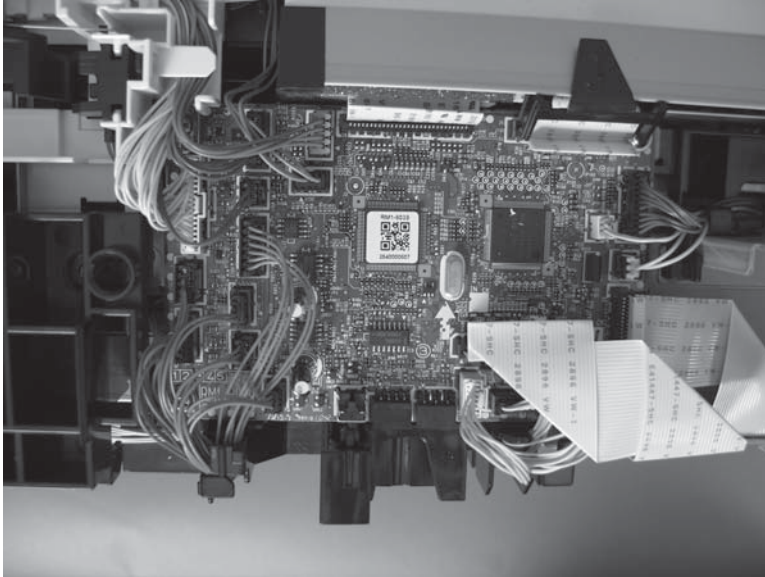
 **CAUTION:** Do not bend or fold the flat flexible cables (FFCs) during removal or installation. Also, do not straighten pre-folds in the FFCs. You *must* make sure that all FFCs are fully seated in their connectors. Failure to fully seat an FFC into a connector can cause a short circuit in a PCA.

 Some parts are sensitive to electrostatic discharge (ESD). Always perform service work at an ESD-protected workstation or mat. If an ESD workstation or mat is not available, ground yourself by touching the sheet-metal chassis *before* touching an ESD-sensitive part.

1. Disconnect all of the connectors.

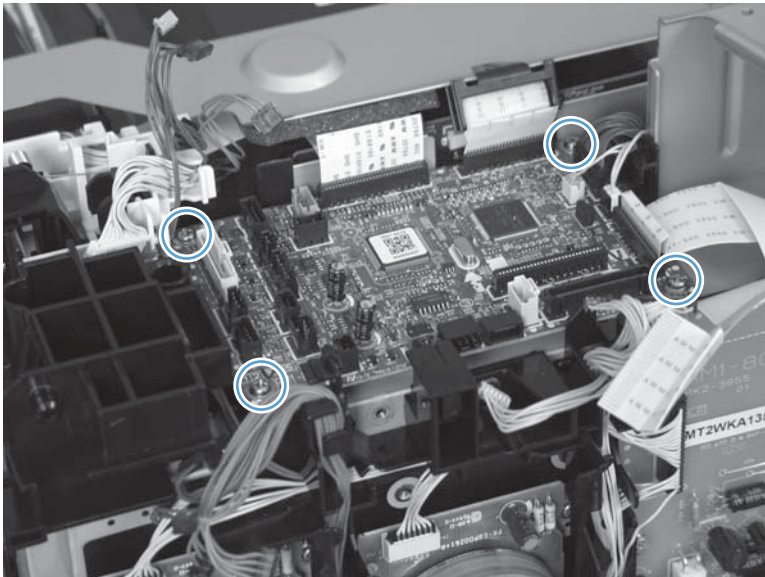
 **NOTE:** The DC controller is located along the top right of the product.

Figure 1-91 Remove the DC controller PCA (1 of 2)



2. Remove four screws (callout 1) and then remove the DC controller PCA.

Figure 1-92 Remove the DC controller PCA (2 of 2)



Fuser-motor assembly

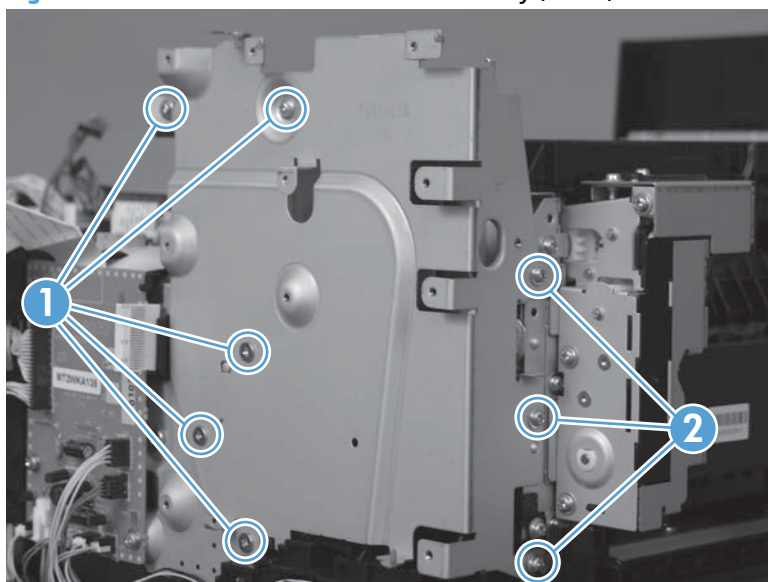
Before proceeding, remove the following components:

- Right cover. See [Right cover on page 25](#).
- Control panel and right-arm mount. See [Control panel and right-arm mount on page 39](#).
- Formatter and fax PCAs. See [Formatter PCA on page 65](#).
- Rear-upper cover. See [Rear-upper cover on page 28](#).

Remove the fuser-motor assembly

1. Remove 5 screws (callout 1) and 3 screws (callout 2).

Figure 1-93 Remove the fuser-motor assembly (1 of 6)



2. Remove three screws (callout 1) and release the wire harness from the retainer. Remove the fan assembly.


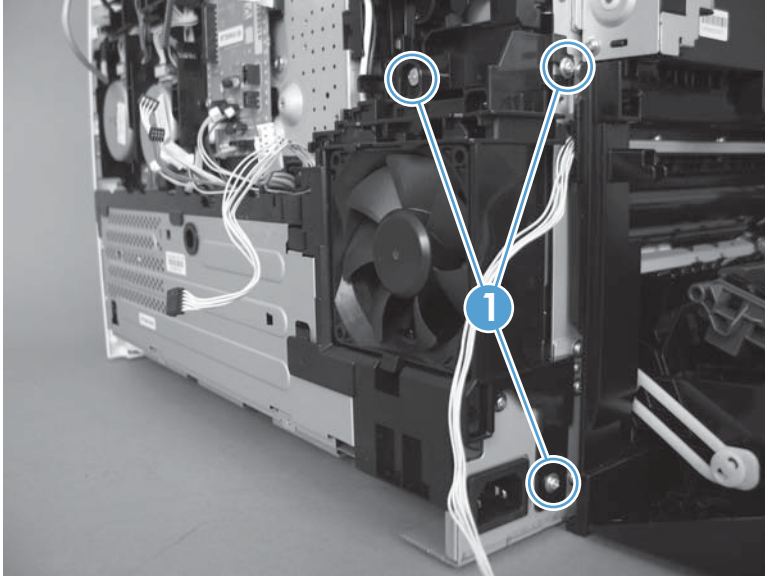
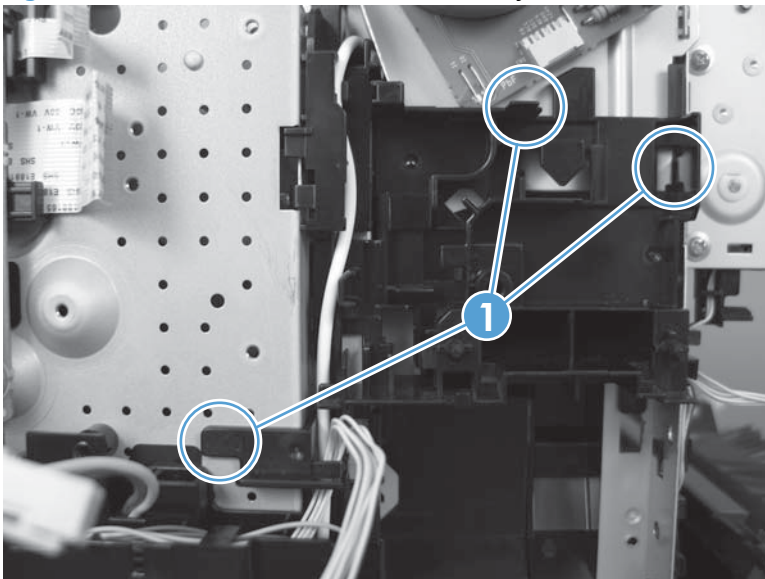
 **NOTE:** The fan assembly is still attached to the product. Move the fan assembly off to one side.

Figure 1-94 Remove the fuser-motor assembly (2 of 6)



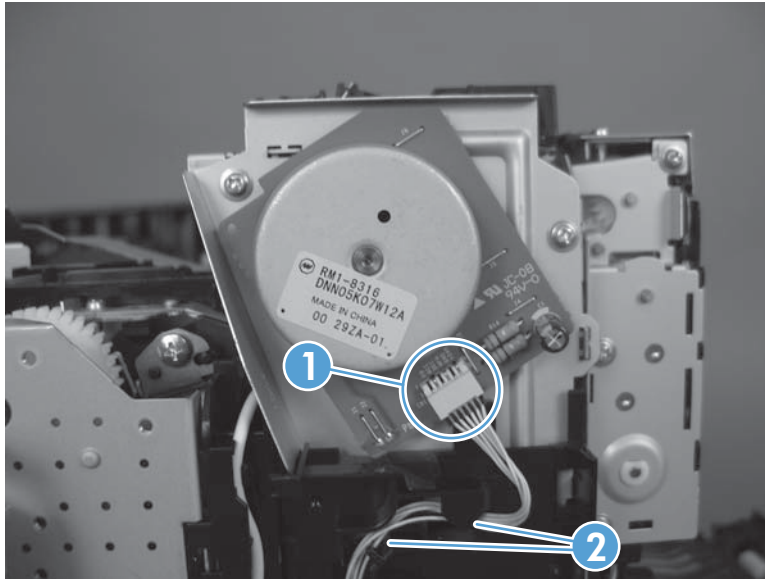
3. Release three tabs (callout 1), and then remove the retainer.

Figure 1-95 Remove the fuser-motor assembly (3 of 6)



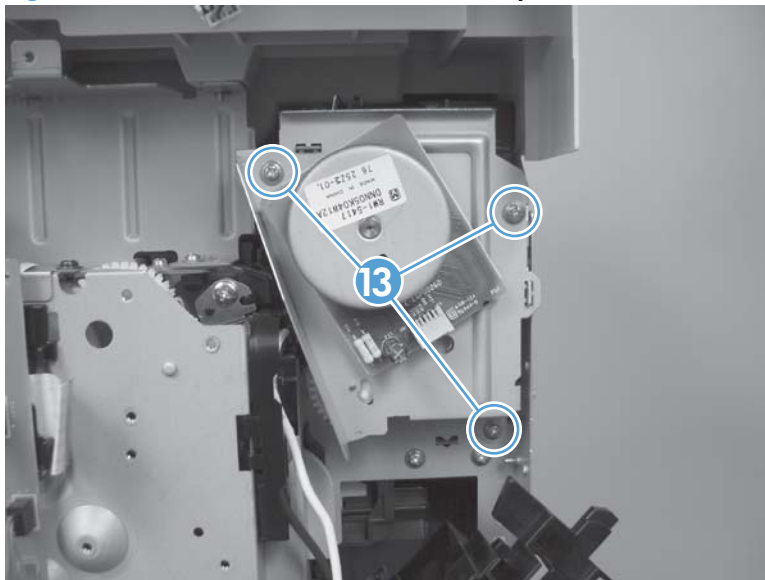
4. Disconnect one connector (callout 1) and remove the wire harness from the retainer (callout 2).

Figure 1-96 Remove the fuser-motor assembly (4 of 6)



5. Remove three screws (callout 1), and then remove the fuser-motor assembly.

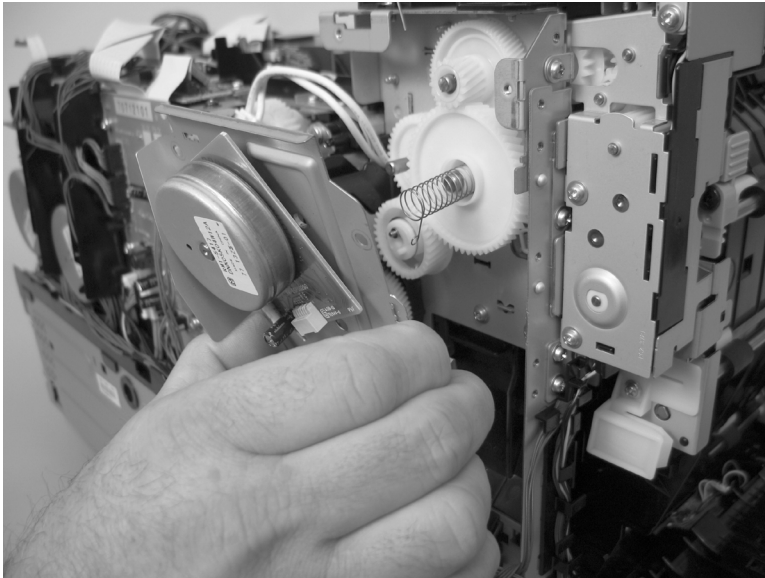
Figure 1-97 Remove the fuser-motor assembly (5 of 6)



6. Before you proceed, take note that the spring and the gears behind the fuser-motor assembly are not captive.

CAUTION: Do not lose the spring or gears when you remove the fuser-motor assembly.

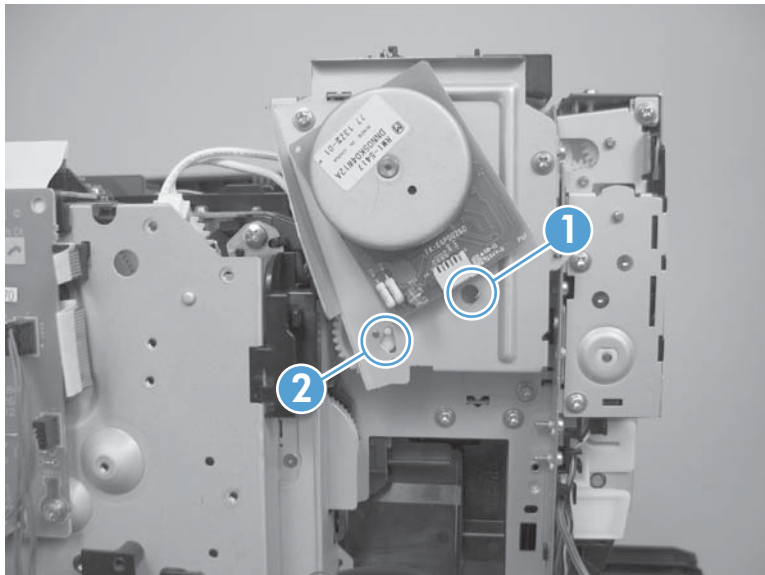
Figure 1-98 Remove the fuser-motor assembly (6 of 6)



Reinstall the fuser-motor assembly

Make sure that the fuser-motor assembly spring (callout 1) and gear pin (callout 2) are correctly positioned in the hole and slot provided in the assembly mounting bracket. The assembly mounting bracket will fit flat against the product chassis when the fuser-motor assembly is correctly installed.

Figure 1-99 Reinstall the fuser-motor assembly



High-voltage power-supply PCA

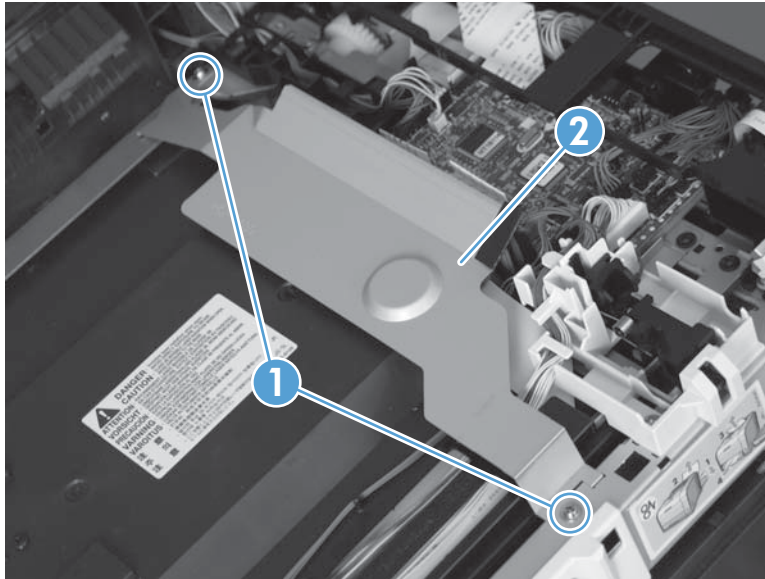
Before proceeding, remove the following components:

- Right cover. See [Right cover on page 25](#).
- Scanner assembly. See [Scanner assembly on page 17](#).
- Rear door. See [Rear door on page 30](#).
- Rear-lower cover. See [Rear-lower cover and rear-door links on page 32](#).
- Upper-cover assembly. See [Upper-cover assembly on page 42](#).
- Left cover. See [Left cover on page 45](#).

Remove the high-voltage power-supply PCA

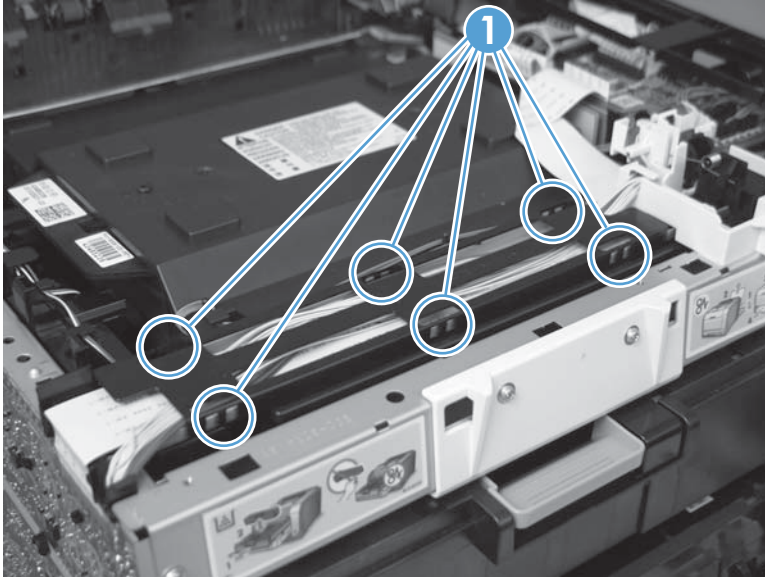
1. Remove two screws (callout 1), and then remove the sheet-metal plate (callout 2).

Figure 1-100 Remove the high-voltage power-supply PCA (1 of 5)



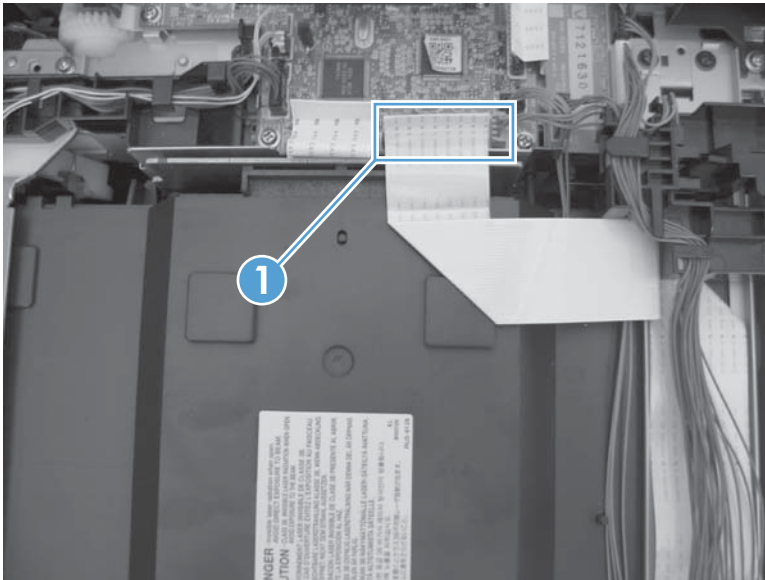
2. Release six tabs (callout 1), and then remove the black-plastic cover.

Figure 1-101 Remove the high-voltage power-supply PCA (2 of 5)



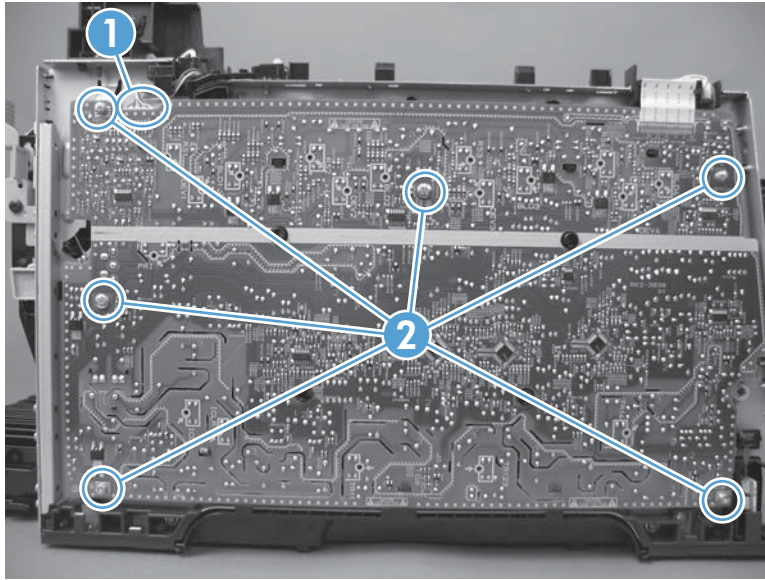
3. Disconnect one FFC (callout 1) on the DC controller.

Figure 1-102 Remove the high-voltage power-supply PCA (3 of 5)



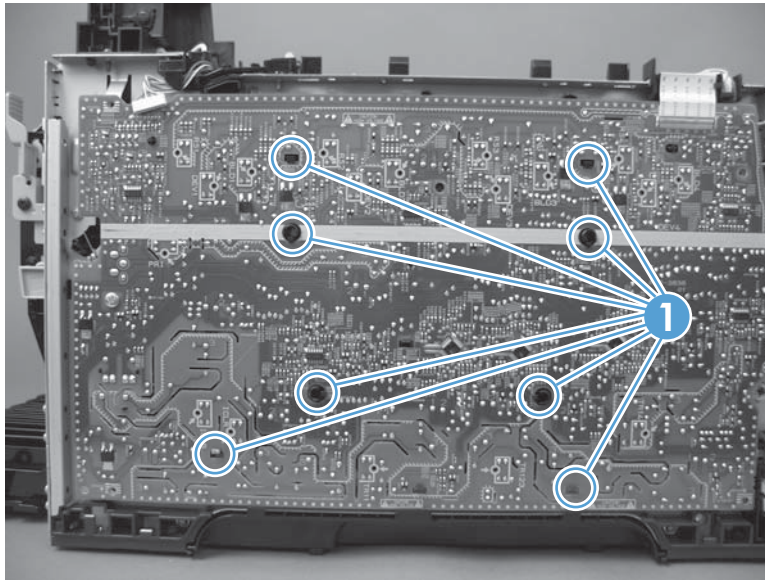
4. Disconnect one connector (callout 1), and then remove six screws (callout 2).

Figure 1-103 Remove the high-voltage power-supply PCA (4 of 5)



5. Release ten tabs (callout 1), and then remove the high-voltage power-supply PCA.

Figure 1-104 Remove the high-voltage power-supply PCA (5 of 5)



Color-misregistration sensor assembly

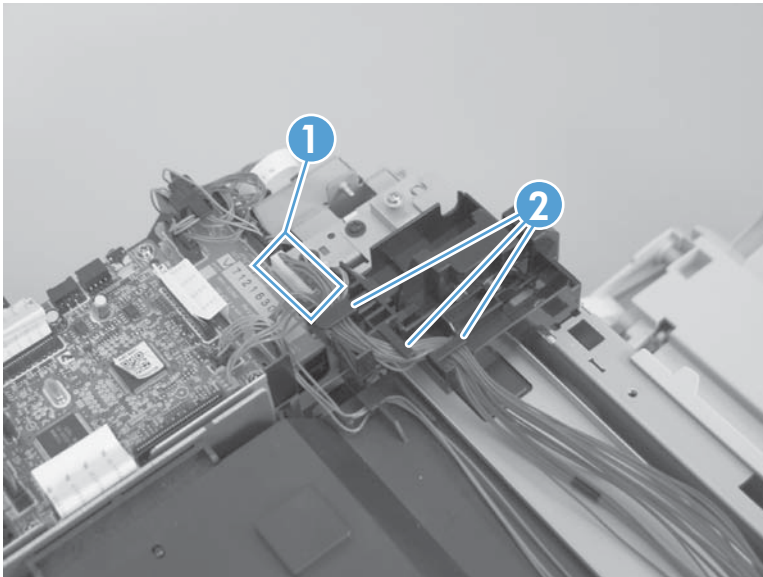
Before proceeding, remove the following components:

- Print-cartridge drawer. See [Print-cartridge drawer on page 22](#).
- Right cover. See [Right cover on page 25](#).
- Scanner assembly. See [Scanner assembly on page 17](#).
- Rear-lower cover. See [Rear-lower cover and rear-door links on page 32](#).
- Upper-cover assembly. See [Upper-cover assembly on page 42](#).
- Left cover. See [Left cover on page 45](#).
- High-voltage power-supply PCA. See [High-voltage power-supply PCA on page 75](#).

Remove the color-misregistration sensor assembly

1. Disconnect one connector (callout 1), and then release the wire harness from the guide (callout 2).

Figure 1-105 Remove the color-misregistration sensor assembly PCA (1 of 4)



2. Release the wire harness from the guide (callout 1).


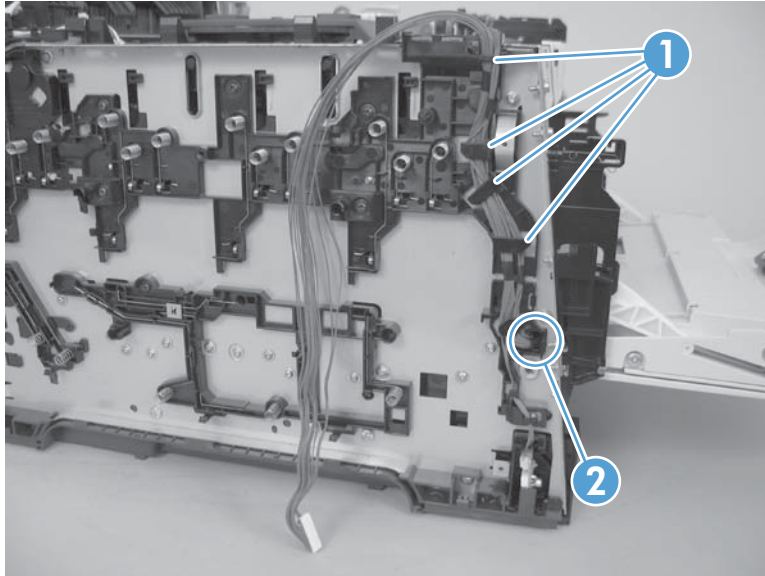
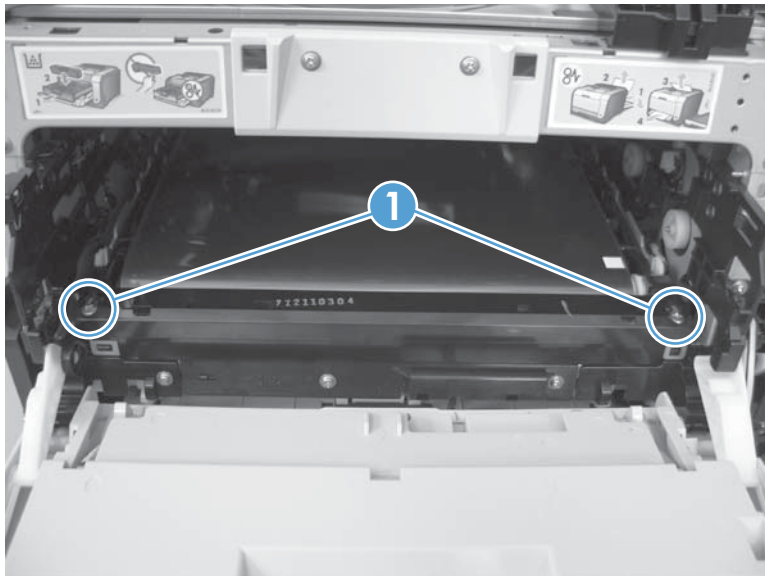
 **NOTE:** When you remove the sensor assembly later in this procedure, pass the connector and wire harness through the hole in the chassis (callout 2).

Figure 1-106 Remove the color-misregistration sensor assembly PCA (2 of 4)



3. Remove two screws (callout 1).

Figure 1-107 Remove the color-misregistration sensor assembly PCA (3 of 4)



4. Carefully separate the sensor assembly (callout 1) from the product, pass the wire harness through the hole in the chassis, and then remove the assembly.



 **NOTE:** Pass the connector and wire harness through the hole in the chassis. See [Figure 1-106 Remove the color-misregistration sensor assembly PCA \(2 of 4\) on page 79](#).

Figure 1-108 Remove the color-misregistration sensor assembly PCA (4 of 4)



Reinstall the color-misregistration sensor assembly

 **TIP:** You might have to attempt this reinstall procedure several times before you successfully pass the connector through the hole in the chassis.

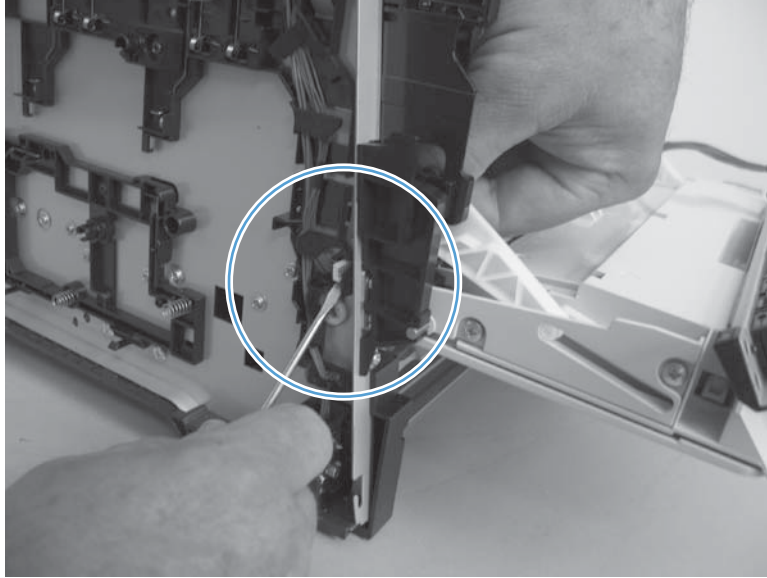
1. Push the sensor assembly wire-harness connector into the hole in the chassis from the ITB side of the product.

Figure 1-109 Reinstall the color-misregistration sensor assembly PCA (1 of 2)



2. Use a small flat blade screwdriver to guide the connector through the hole.

Figure 1-110 Reinstall the color-misregistration sensor assembly PCA (2 of 2)

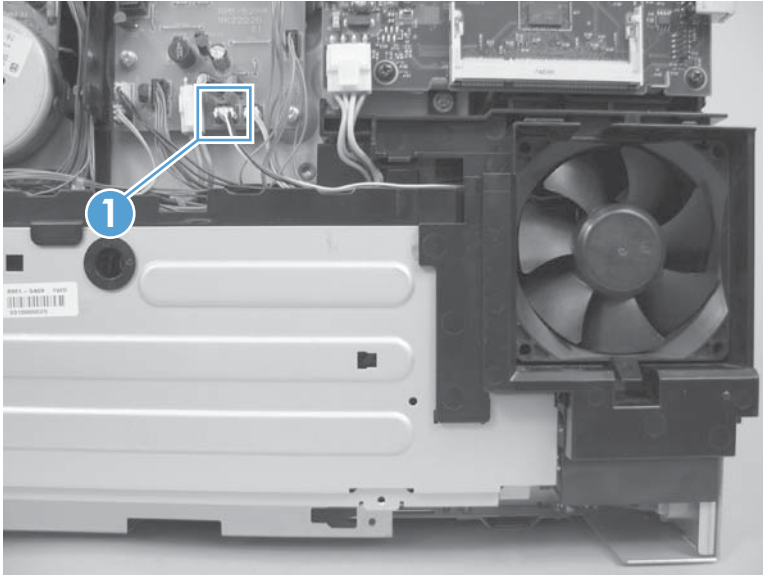


Fan (FM1)

CAUTION: When the fan is reinstalled, it must pull air into the product. The air-flow indicator arrow embossed on the fan chassis point into the fan duct when the fan is correctly installed.

1. Remove the right cover. See [Right cover on page 25](#).
2. Disconnect one connector (callout 1; J206)

Figure 1-111 Remove the fan (FM1) (1 of 2)

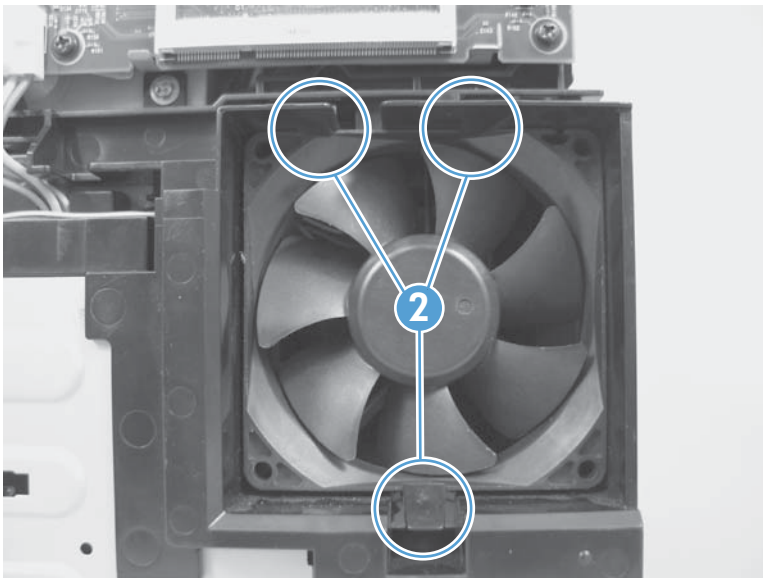


3. Release three tabs (callout 1), and then remove the fan.

NOTE: As the fan is removed, you must feed the wire harness through an opening behind the fan duct.

TIP: Use a small flat blade screwdriver to release the upper two tabs on the fan duct a second time when the fan is about half way out of the duct.

Figure 1-112 Remove the fan (FM1) (2 of 2)



USB PCA (fax/memory-card models)

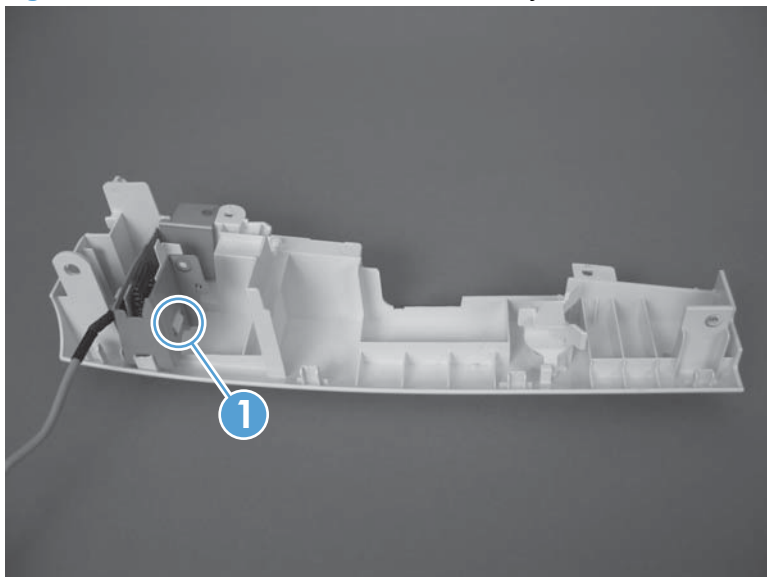
Before proceeding, remove the following components:

- Right cover. See [Right cover on page 25](#).
- Right-front cover and power button. See [Right-front cover and power button on page 26](#).

Remove the USB PCA

Release one tab (callout 1), and then remove the USB PCA.

Figure 1-113 Remove the USB PCA (fax/memory-card models)



Duplex-reverse drive assembly

Before proceeding, remove the following components:

- Right cover. See [Right cover on page 25](#).
- Scanner assembly. See [Scanner assembly on page 17](#).
- Rear-upper cover. See [Rear-upper cover on page 28](#).
- Rear door. See [Rear door on page 30](#).
- Rear-lower cover. See [Rear-lower cover and rear-door links on page 32](#).
- Upper-cover assembly. See [Upper-cover assembly on page 42](#).

Remove the duplex-reverse drive assembly

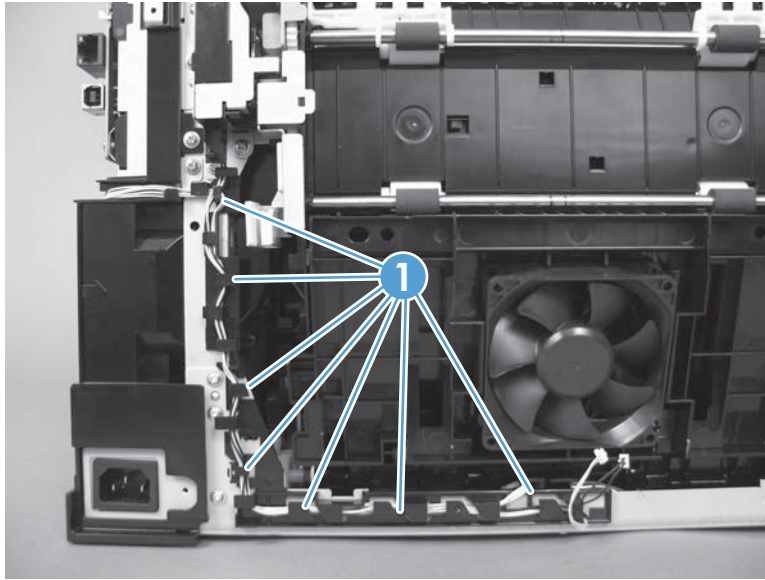
1. Disconnect two connectors (callout 1), and then pass the connectors under the rear-door rib assembly.

Figure 1-114 Remove the duplex-reverse drive assembly (1 of 4)



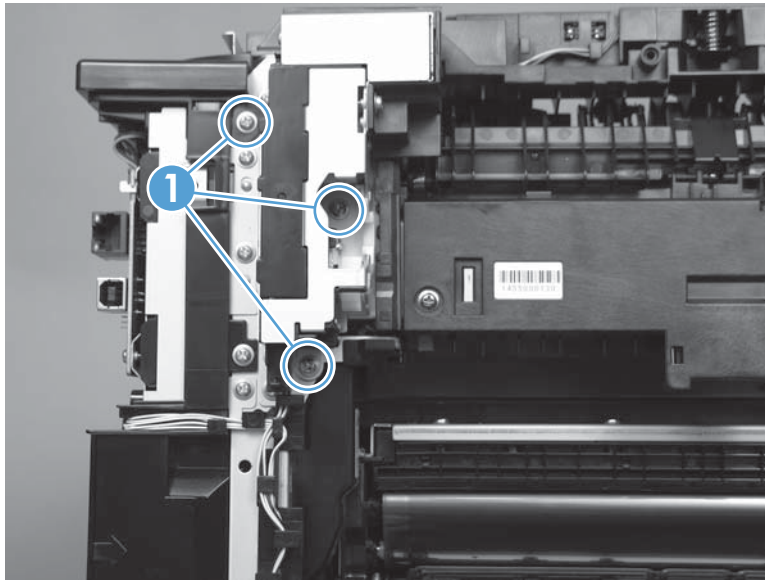
2. Release the wire harnesses from the retainer (callout 1).

Figure 1-115 Remove the duplex-reverse drive assembly (2 of 4)



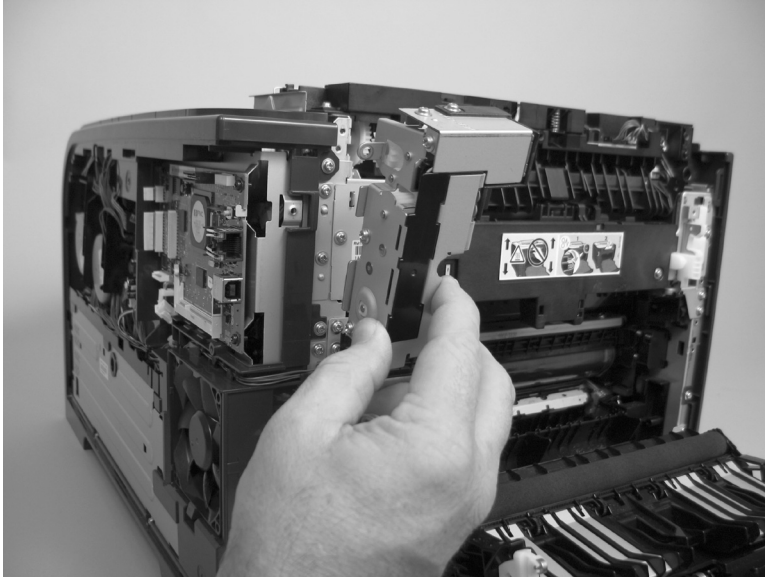
3. Remove three screws (callout 1).

Figure 1-116 Remove the duplex-reverse drive assembly (3 of 4)




4. Remove the duplex-reverse drive assembly.

Figure 1-117 Remove the duplex-reverse drive assembly (4 of 4)




Fuser

 **NOTE:** The fuser can be removed without removing the scanner assembly and the upper-cover assembly. However, it might be easier to access some of the connectors with these components removed.

Before proceeding, remove the following components:

- Right cover. See [Right cover on page 25](#).
- Scanner assembly. See [Scanner assembly on page 17](#).
- Rear-upper cover. See [Rear-upper cover on page 28](#).
- Rear door. See [Rear door on page 30](#).
- Rear-lower cover. See [Rear-lower cover and rear-door links on page 32](#).
- Upper-cover assembly. See [Upper-cover assembly on page 42](#).
- Left cover. See [Left cover on page 45](#).

Remove the fuser

 **WARNING!** The fuser might be very hot. After turning off the product power, allow the fuser to cool for at least 5 minutes before removing it.

1. Remove three screws (callout 1) and separate the duplex-reverse drive assembly from the product.


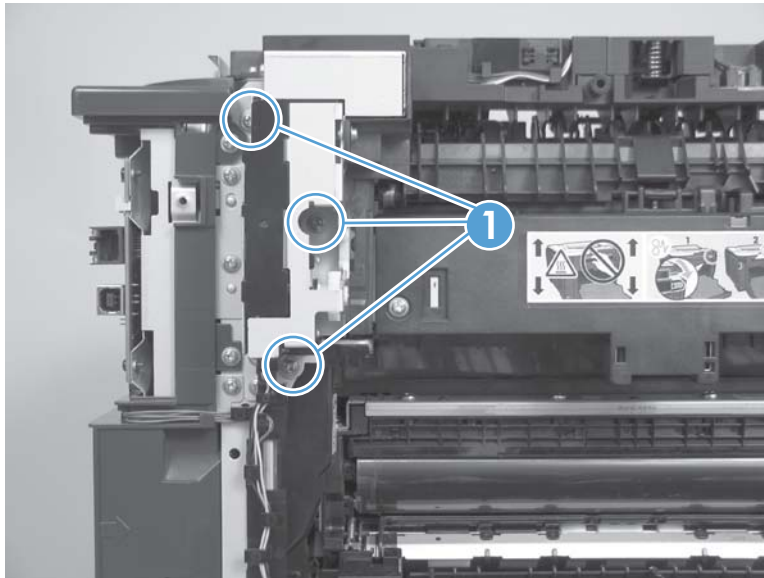
 **CAUTION:** The duplex-reverse drive assembly is still attached to the product. Carefully set the assembly out of the way.

Figure 1-118 Remove the fuser (1 of 8)



2. Disconnect two connectors (callout 1), and then release the wire harnesses from the guide (callout 2).


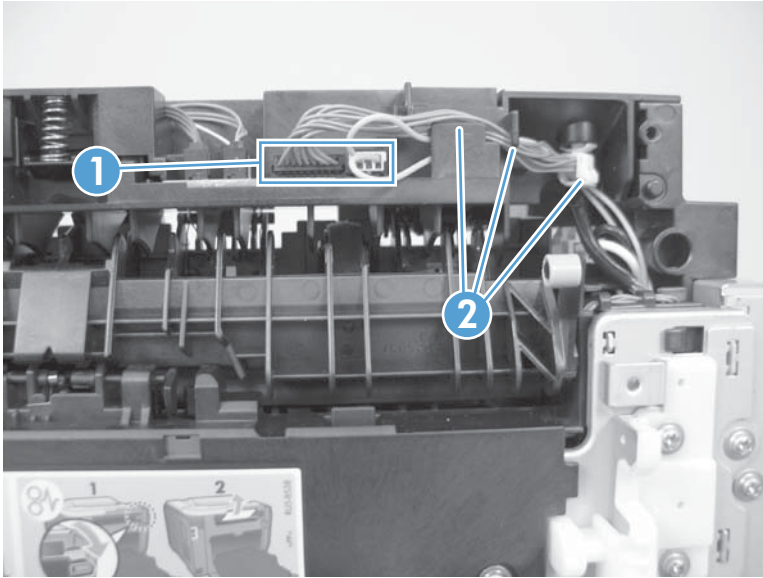
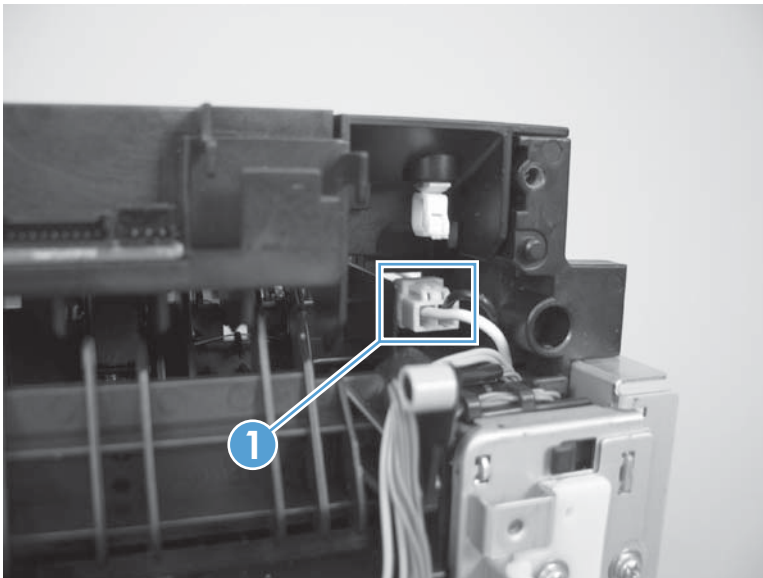
 **Reinstallation tip** When the upper cover is reinstalled, make sure that these wire harnesses (near the connectors) are correctly routed under the cover.

Figure 1-119 Remove the fuser (2 of 8)



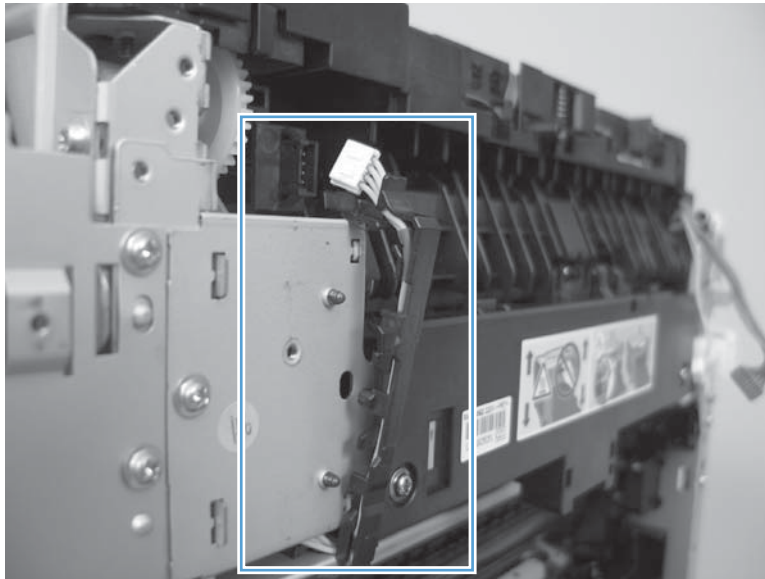
3. Disconnect one connector (callout 1).

Figure 1-120 Remove the fuser (3 of 8)



4. In the following step, the connector and guide will be separated from the fuser. You **must not** use too much force and damage the lower portion of the guide. If the guide is damaged, the fuser must be replaced.

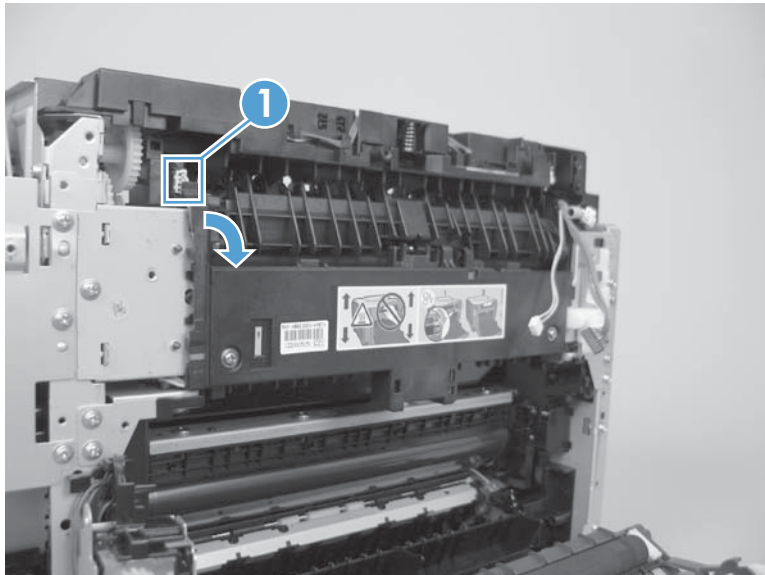
Figure 1-121 Remove the fuser (4 of 8)



5. Carefully disconnect one connector (callout 1) and then rotate the connector and the top portion of the guide away from the fuser.

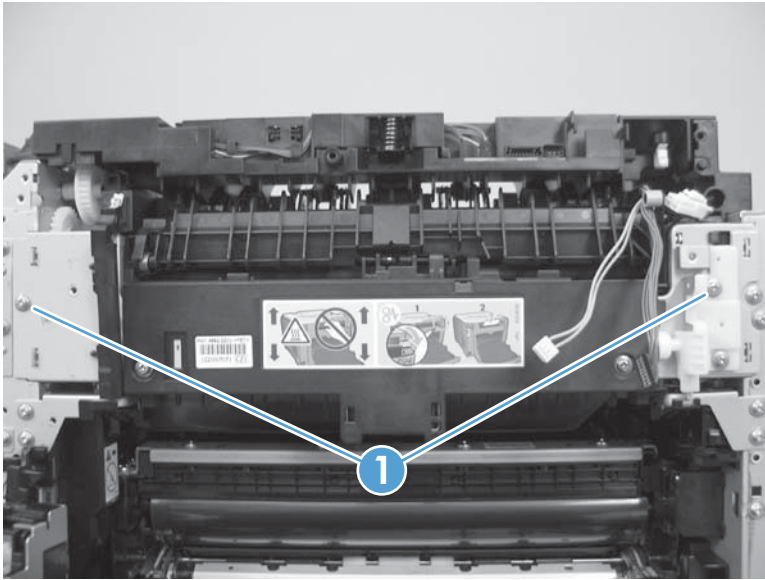
CAUTION: Do not separate the connector and guide more than is shown in [Figure 1-121 Remove the fuser \(4 of 8\) on page 89](#). If the guide is damaged, you must replace the fuser. Do not damage the connector.

Figure 1-122 Remove the fuser (5 of 8)



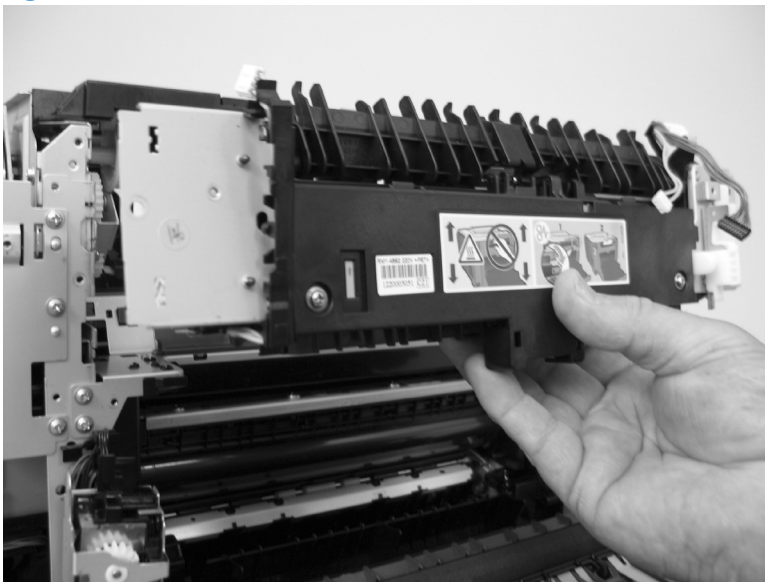
6. Remove two screws (callout 1).

Figure 1-123 Remove the fuser (6 of 8)



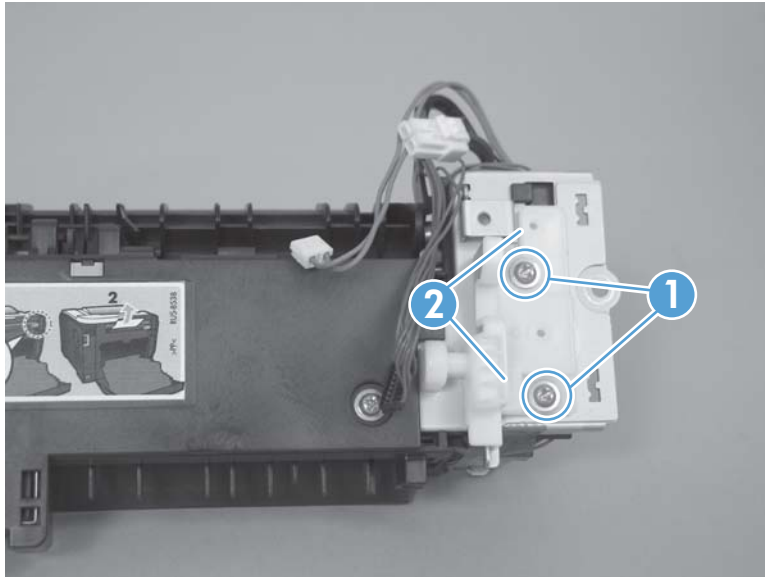
7. Remove the fuser.

Figure 1-124 Remove the fuser (7 of 8)



8. Remove two screws (callout 1) and remove the duplex-gear assembly (callout 2). Install the assembly on the replacement fuser.

Figure 1-125 Remove the fuser (8 of 8)

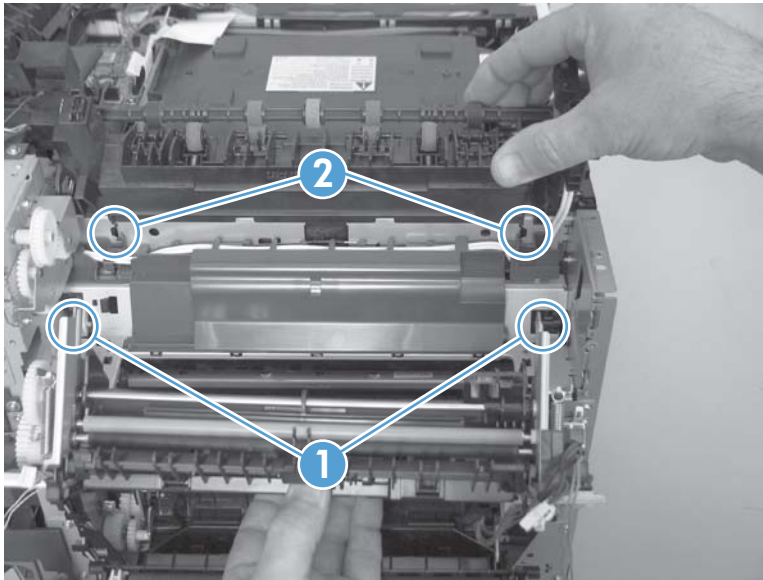


Reinstall the fuser

To reinstall you must insert the tabs (callout 1) on the fuser frame into the slots on the product chassis (callout 2).

CAUTION: The fuser frame must be flush with the product chassis before you install the two fuser mounting screws. **Do not** use the screws to pull the fuser frame against the chassis.

Figure 1-126 Reinstall the fuser



Paper-delivery assembly

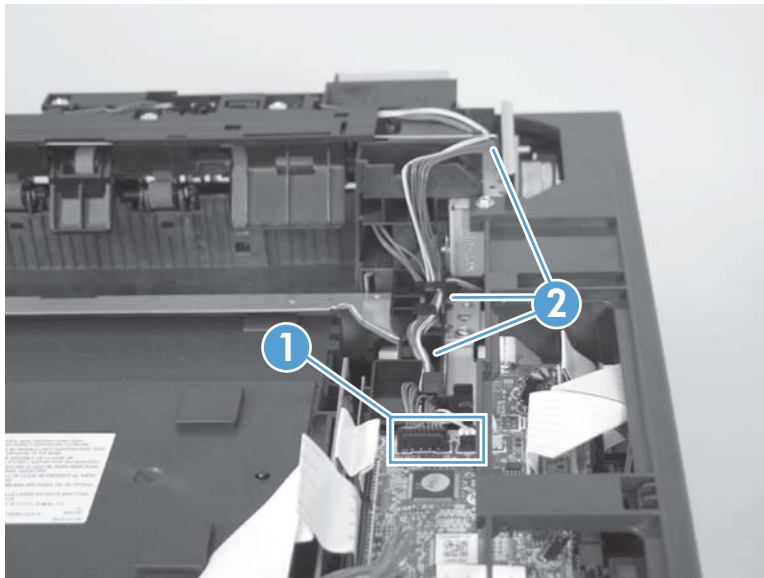
Before proceeding, remove the following components:

- Right cover. See [Right cover on page 25](#).
- Scanner assembly. See [Scanner assembly on page 17](#).
- Rear-upper cover. See [Rear-upper cover on page 28](#).
- Rear door. See [Rear door on page 30](#).
- Rear-lower cover. See [Rear-lower cover and rear-door links on page 32](#).
- Upper-cover assembly. See [Upper-cover assembly on page 42](#).
- Left cover. See [Left cover on page 45](#).

Remove the paper-delivery assembly

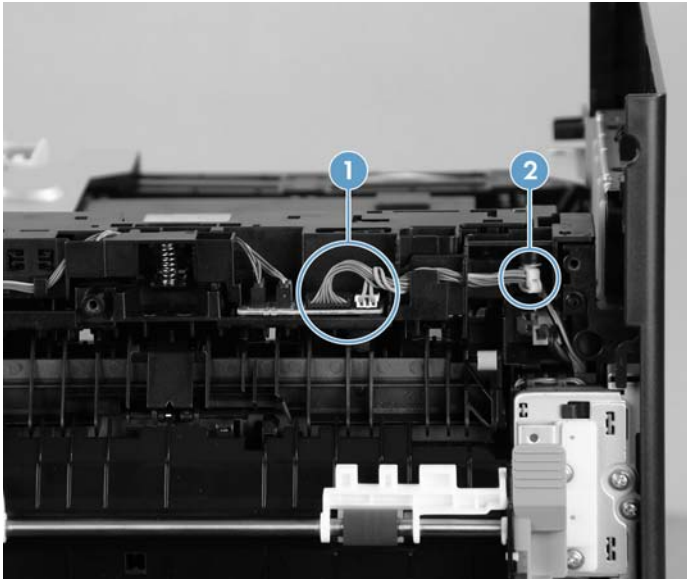
1. Disconnect three connectors (callout 1), and then release the wire harnesses from the retainer (callout 2).

Figure 1-127 Remove the paper-delivery assembly (1 of 4)



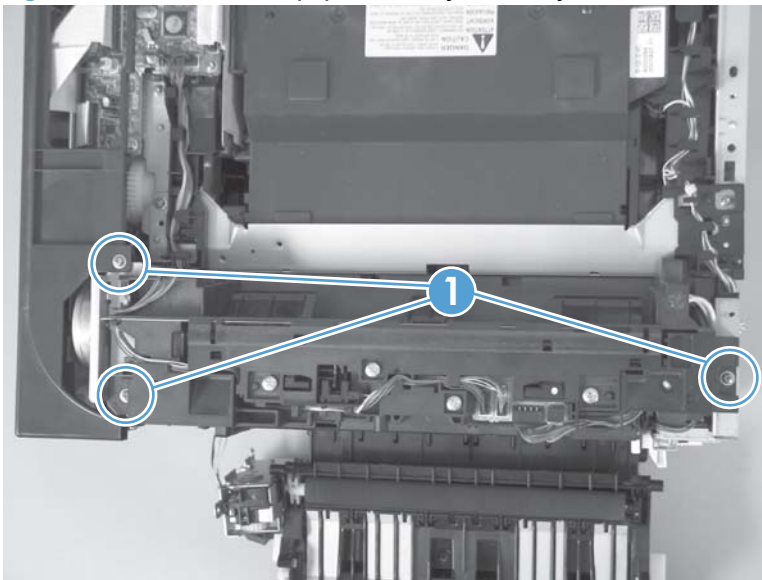
2. Disconnect two connectors (callout 1), and then release the wire harness from the wire clip (callout 2).

Figure 1-128 Remove the paper-delivery assembly (2 of 4)



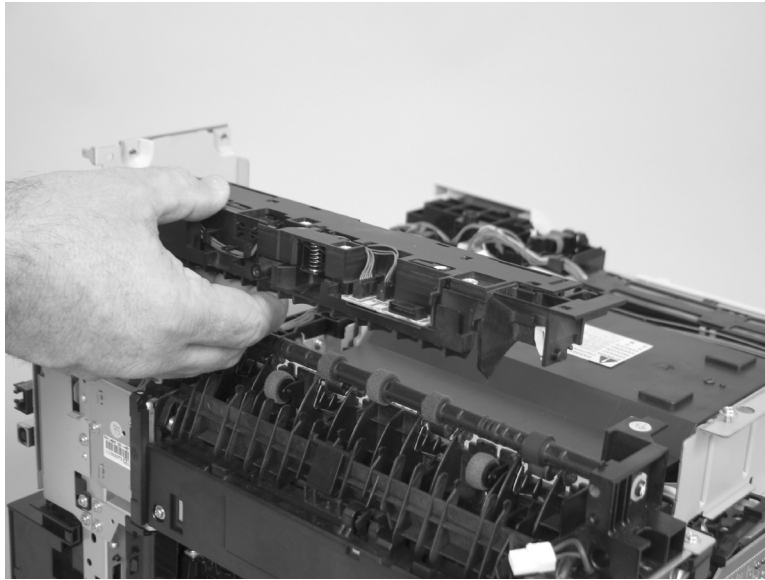
3. Remove three screws (callout 1).

Figure 1-129 Remove the paper-delivery assembly (3 of 4)



4. Remove the paper-delivery assembly.

Figure 1-130 Remove the paper-delivery assembly (4 of 4)



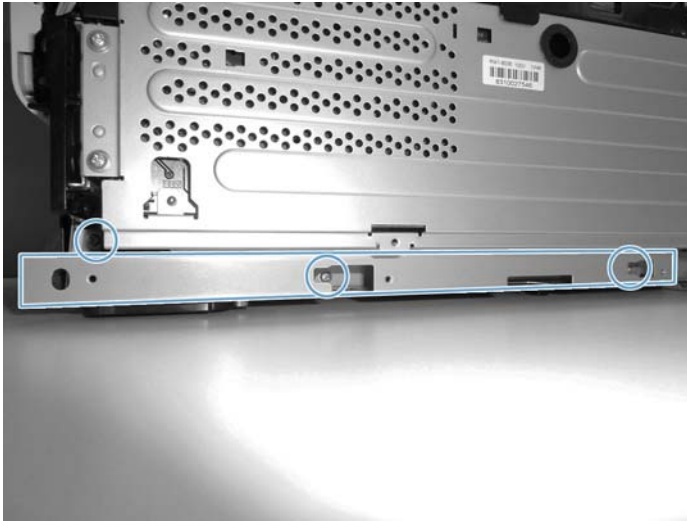
Low voltage power supply

Before removing the low voltage power supply, remove the following parts:

- Right cover.
- Right-front cover and power button.
- Scanner assembly.
- M476nw only: Rear door.
- M476dn and M476dw: Rear-upper cover.
- Control panel and right-arm mount.
- Upper-cover assembly.

1. Remove three screws to release the metal brace.

Figure 1-131 Remove three screws

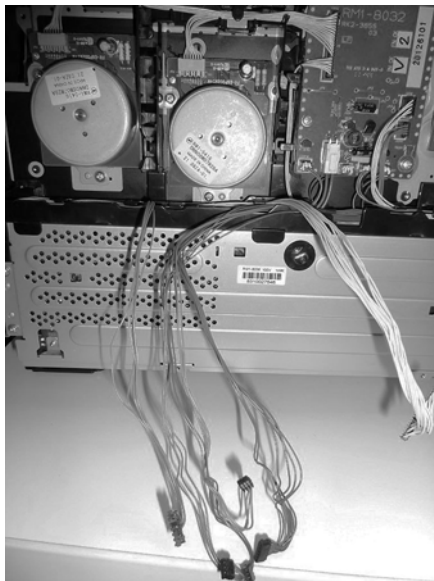


2. Disconnect the plugs from the DCC that run down the right side of the product.

Figure 1-132 Original routing of wires to be removed

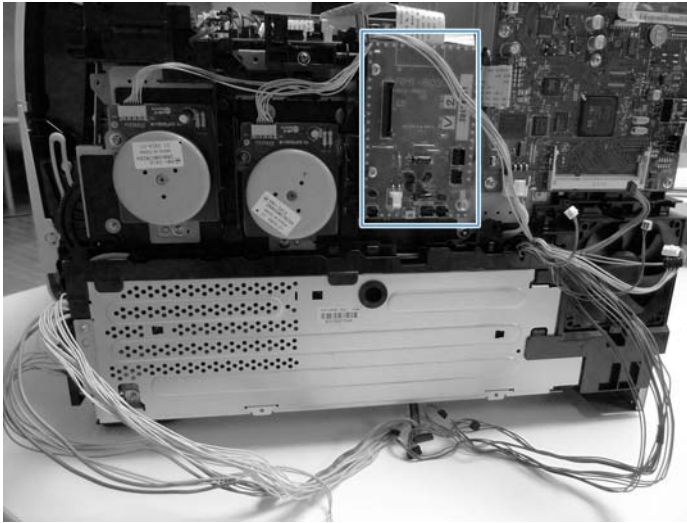


Figure 1-133 DCC plugs disconnected



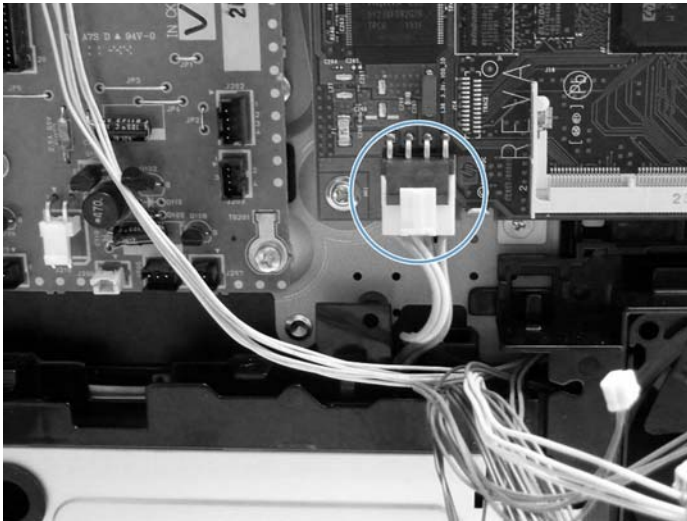
3. Remove the cables from the wire guides and then disconnect the plugs from the Driver PCA.

Figure 1-134 Unplugged wires have been removed from the wire guides and plugs from the Driver PCA have been disconnected



4. Disconnect the large plug from the formatter board.

Figure 1-135 Disconnect the plug on the formatter board



5. Release the two tabs on the right side of the plastic wire guide from the lower-right front of the product, then remove the plastic wire guide.

Figure 1-136 Plastic wire frame

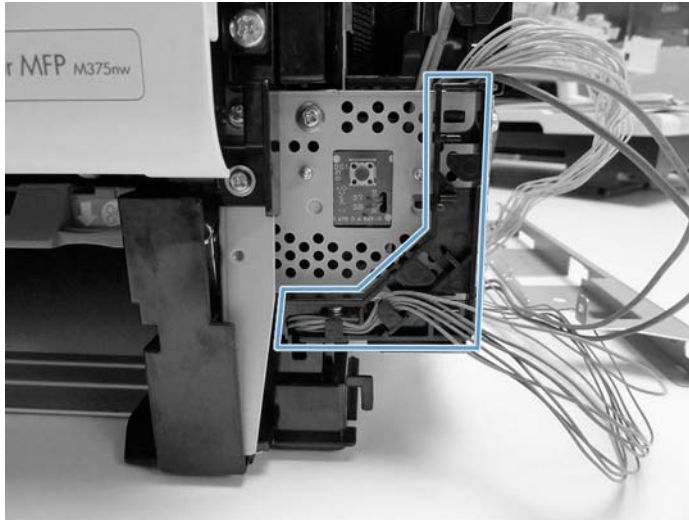
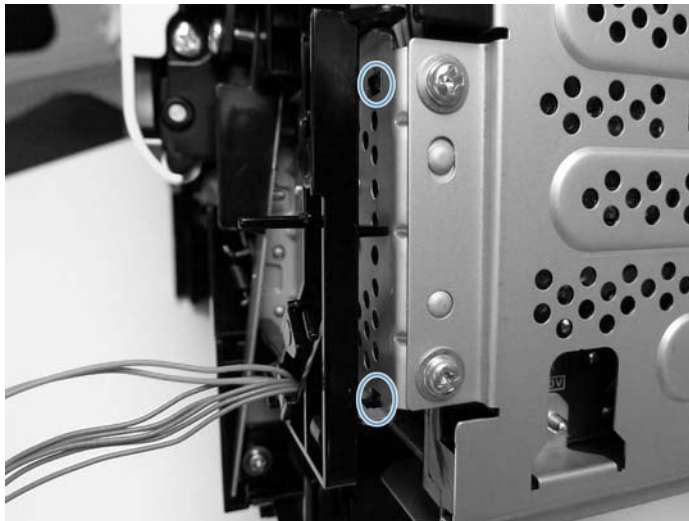
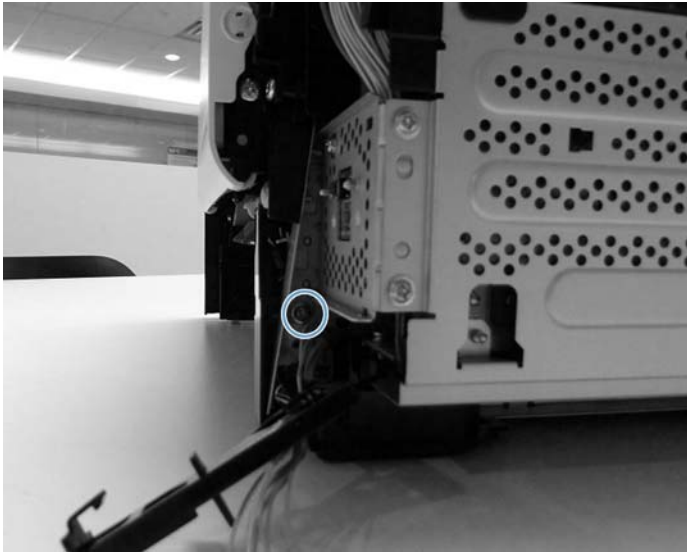


Figure 1-137 Tabs to release



6. Remove one screw from the front-right corner of the product.

Figure 1-138 Remove one screw



7. Remove one screw above and left of the power switch.

Figure 1-139 Remove one screw above and left of the power switch



8. Remove the screw holding the tray 3 harness and pin guide in place.

Figure 1-140 Remove the screw holding the tray 3 harness in place



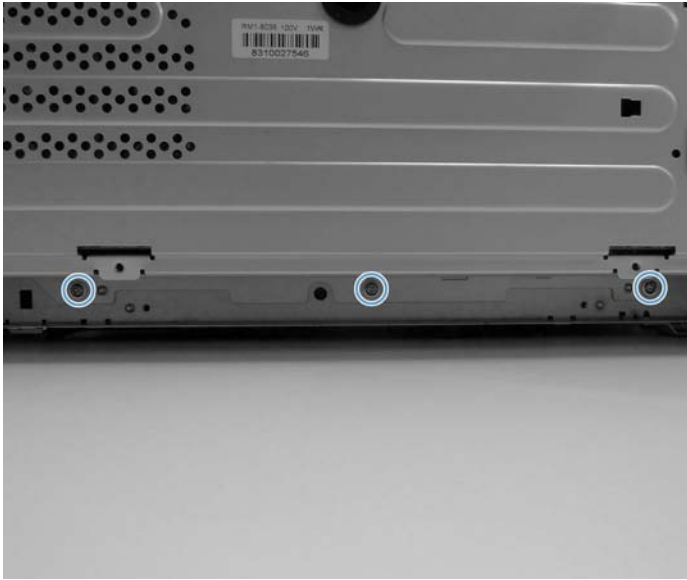
9. Set the printer on its left side or slide the right front corner off a table so the tray 3 harness and pin guide can be removed, then remove the tray 3 harness and pin guide.

Figure 1-141 Remove the tray 3 harness and pin guide



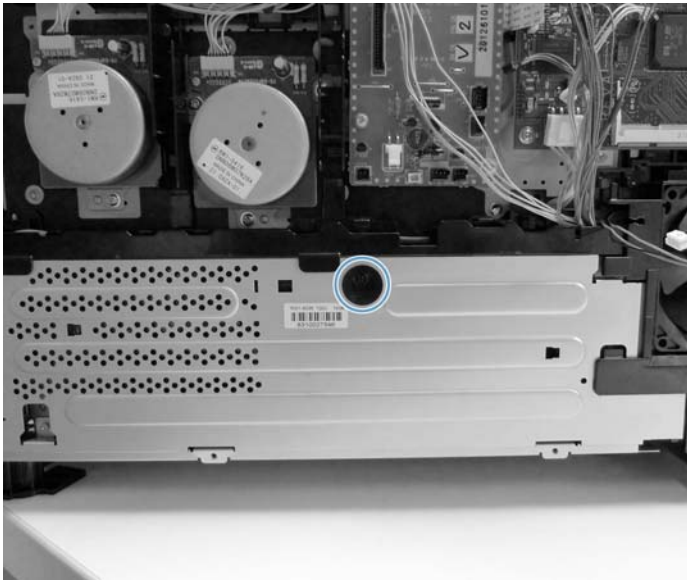
10. Remove the lower three screws securing the low voltage power supply.

Figure 1-142 Remove the screws securing the low voltage power supply



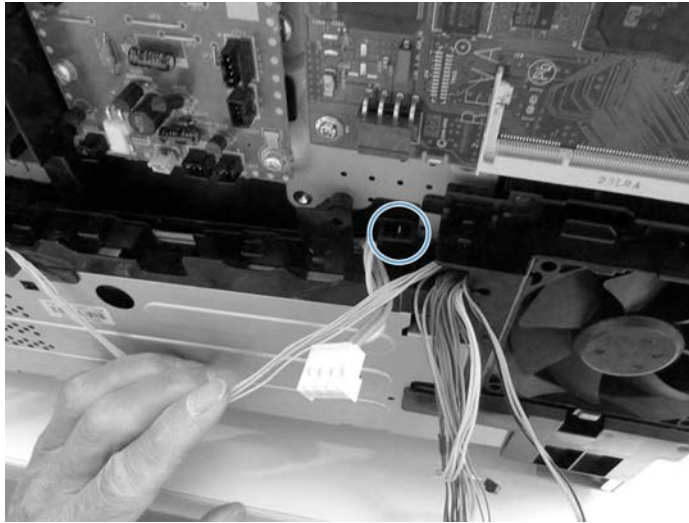
11. Remove one screw securing the top of the low voltage power supply.

Figure 1-143 Remove the screw securing the top of the low voltage power supply



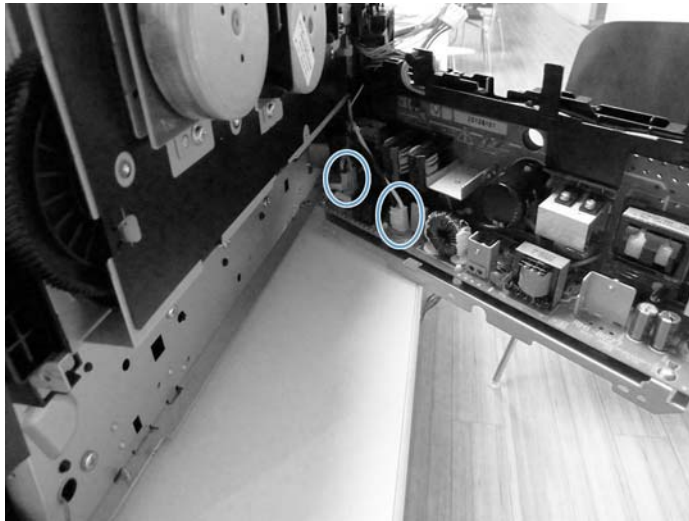
12. Lift the low voltage power supply up so that it clears the metal hanger.

Figure 1-144 Lift the low voltage power supply



13. Pull the front of the low voltage power supply out to the side to gain access to the two plugs pictured and then disconnect the plugs.

Figure 1-145 Disconnect two plugs



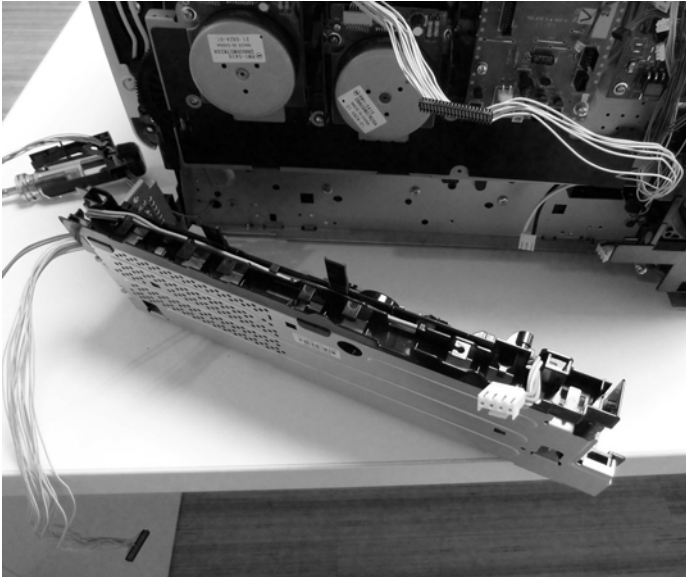
14. Remove the screw securing the ground strap.

Figure 1-146 Remove the ground strap



15. Remove the low voltage power supply from the product.

Figure 1-147 Remove the low voltage power supply



Trays

Tray cassettes and optional Tray 3 assembly

1. **Tray 2 and Tray 3 cassette:** Pull the tray straight out of the product to remove it.

Figure 1-148 Remove the tray cassettes and optional Tray 3 assembly (1 of 2)



2. **Optional Tray 3 assembly:** Lift the product straight up from the assembly, and then set the product on a sturdy, level surface.

CAUTION: Lift the product by using the right- and left-side hand-holds. Do not lift the product by grasping the Tray 2 cassette, or the cavity created if the cassette is removed.

Figure 1-149 Remove the tray cassettes and optional Tray 3 assembly (2 of 2)



2 Parts and diagrams

- [Order parts, accessories, and supplies](#)
- [Orderable parts](#)
- [Whole unit replacement \(WUR\)](#)
- [Service parts](#)
- [Related documentation and software](#)
- [How to use the parts lists and diagrams](#)
- [Scanner and document feeder main assembly](#)
- [Covers](#)
- [Internal assemblies](#)
- [Accessories](#)
- [Alphabetical parts list](#)
- [Numerical parts list](#)

Order parts, accessories, and supplies

You can obtain the following items directly from HP:

- **Replacement parts:** To order replacement parts in the U.S., go to www.hp.com/go/hpparts/. Outside the United States, order parts by contacting your local authorized HP service center.
- **Supplies and accessories:** To order supplies in the U.S., go to www.hp.com/go/ljsupplies. To order supplies worldwide, go to www.hp.com/ghp/buyonline.html. To order accessories, go to www.hp.com/support/lj400colorMFPM476.

Orderable parts

Accessories

The following list of accessories was current at the time of printing. Ordering information and availability of the accessories might change during the life of the product.

Table 2-1 Accessories

Item	Description	Part number
Paper-handling accessories	Optional Tray 3 feeder assembly main body (includes paper cassette)	CE863-67901
	250-sheet paper cassette (optional Tray 3)	RM1-8544-000
Cable	2-meter A-to-B USB cable	8121-0868

Toner cartridges

Table 2-2 Toner cartridges

Description	Cartridge number	Part number (service)
High-capacity black toner cartridge with HP ColorSphere toner	CF380X	CF380-67901
Standard-capacity black toner cartridge with HP ColorSphere toner	CF380A	CF380-67902
Cyan toner cartridge with HP ColorSphere toner	CF381A	CF381-67901
Yellow toner cartridge with HP ColorSphere toner	CF382A	CF382-67901
Magenta toner cartridge with HP ColorSphere toner	CF383A	CF383-67901



NOTE: For information about the yield for the cartridges, see www.hp.com/go/pageyield. Actual yield depends on specific use.

Customer self repair (CSR) and service kits

Table 2-3 Customer self repair (CSR) and service kits

Description	Part number
Cover, DIMM	RC4-2852-000
Paper cassette (Tray 2)	RM2-5469-000
250-sheet paper cassette (optional Tray 3)	RM1-8544-000
Optional Tray 3 feeder assembly main body (includes paper cassette)	CE863-67901
2-meter A-to-B USB cable	8121-0868

Whole unit replacement (WUR)

Table 2-4 Pro 400 Color MFP M476 nw

Description	Part number
Prod-Replacement 110V M476nw WUR BR	CF385-67019
Prod-Replacement 220V M476nw WUR CN/MY	CF385-67023
Prod-Exchange 220V M476nw WUR EMEA	CF385-69001
Prod-Exchange 110V M476nw WUR NAR/TW	CF385-69002
Prod-Exchange 220V M476nw WUR AP	CF385-69003
Prod-Exchange 220V M476nw WUR LAR	CF385-69004

Table 2-5 Pro 400 Color MFP M476 dn

Description	Part number
Prod-Exchange 220V M476dn WUR EMEA	CF386-69001
Prod-Exchange 110V M476dn WUR NAR	CF386-69002

Table 2-6 Pro 400 Color MFP M476 dw

Description	Part number
Prod-Replacement 220V M476dw WUR CN/MY	CF387-67022
Prod-Replacement 110V M476dw WUR BR	CF387-67023
Prod-Exchange 220V M476dw WUR EMEA	CF387-69001
Prod-Exchange 110V M476dw WUR NAR/TW	CF387-69002
Prod-Exchange 220V M476dw WUR AP	CF387-69003
Prod-Exchange 220V M476dw WUR LAR	CF387-69004

Service parts

The following service parts are not shown in the exploded view diagrams sections.

Table 2-7 Service parts

Description	Part number
Assy-Control Panel NFC (M476dw)	CF387-60114
Assy-Control Panel Non-NFC (M476nw, M476dn)	CF385-60101


Related documentation and software


Table 2-8 Related documentation and software

Item	Description	Part number
<i>HP Color LaserJet Pro MFP M476 User Guide</i>	Product user guide.	CF385-90907
<i>HP Color LaserJet Pro MFP M476 Repair Manual</i>	English service manual (this manual)	N/A

How to use the parts lists and diagrams

The figures in this chapter show the major subassemblies in the product and their component parts. A parts list table follows each exploded view assembly diagram. Each table lists the item number, the associated part number, and the description of each part. If a part is not listed in the table, then it is not a field replacement unit (FRU).

 **CAUTION:** Be sure to order the correct part. When looking for part numbers for electrical components, pay careful attention to the voltage that is listed in the description column. Doing so will ensure that the part number selected is for the correct all-in-one model.

 **NOTE:** In this manual, the abbreviation “PCA” stands for “printed circuit-board assembly.” Components described as a PCA might consist of a single circuit board or a circuit board plus other parts, such as cables and sensors.

Scanner and document feeder main assembly

Figure 2-1 Scanner and document feeder main assembly

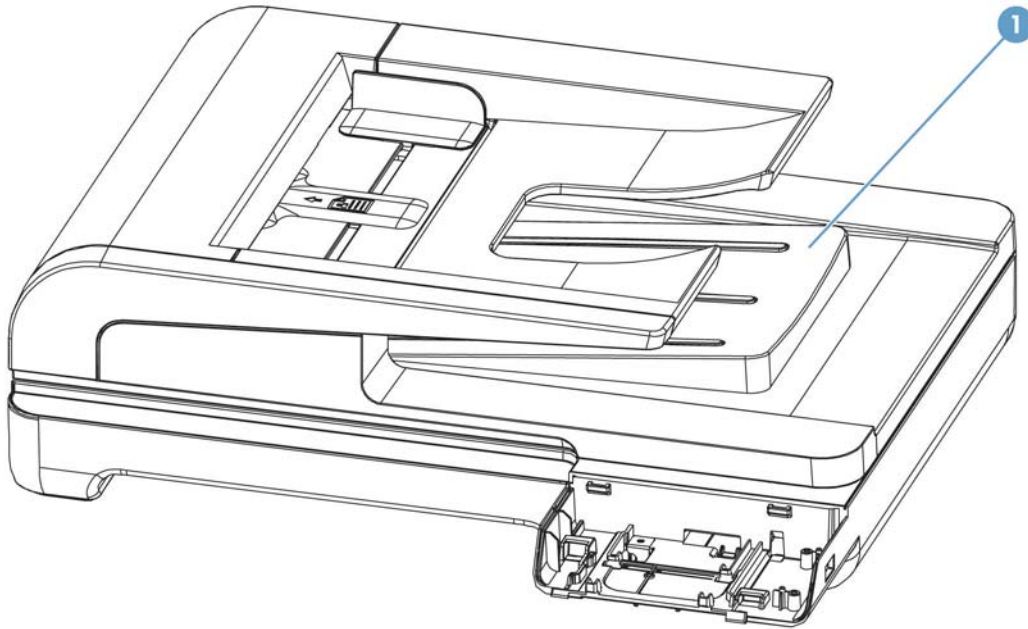


Table 2-9 Scanner and document feeder main assembly

Ref	Description	Part number	Qty
1	Scanner assembly/ADF	CF387-60106	1

Covers

Figure 2-2 External panels and covers

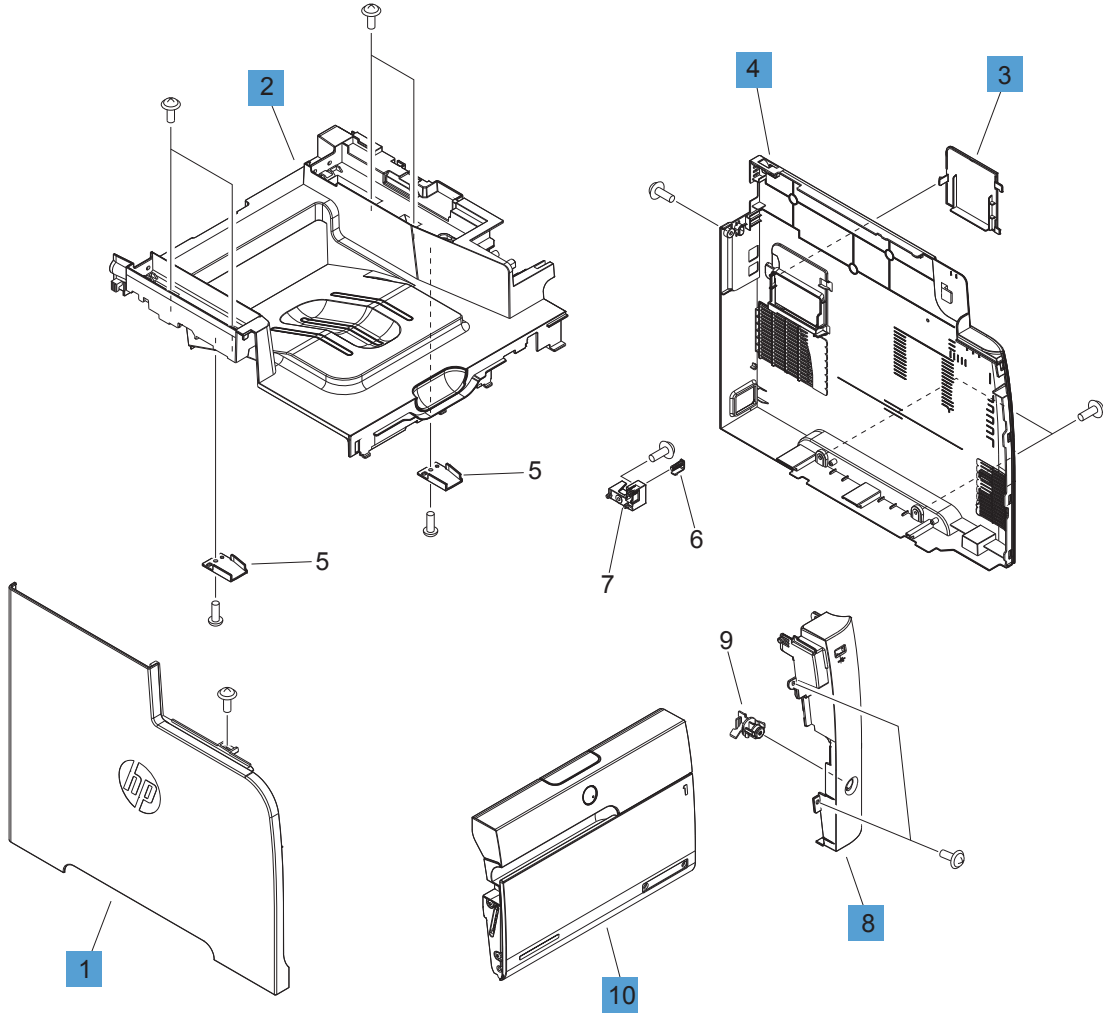


Table 2-10 Covers

Ref	Description	Part number	Qty
1	Cover, left	RL1-3063-000	1
2	Cover, top assembly	RM2-5300-000	1
3	Cover, DIMM	RC4-2852-000	1
4	Cover, right	RC4-2855-000	1
8	Cover, right front	RC4-2860-000	1
10	Door, front assembly	RM2-5301-000	1

Internal assemblies

Internal assemblies (1 of 7)

Figure 2-3 Internal assemblies (1 of 7)

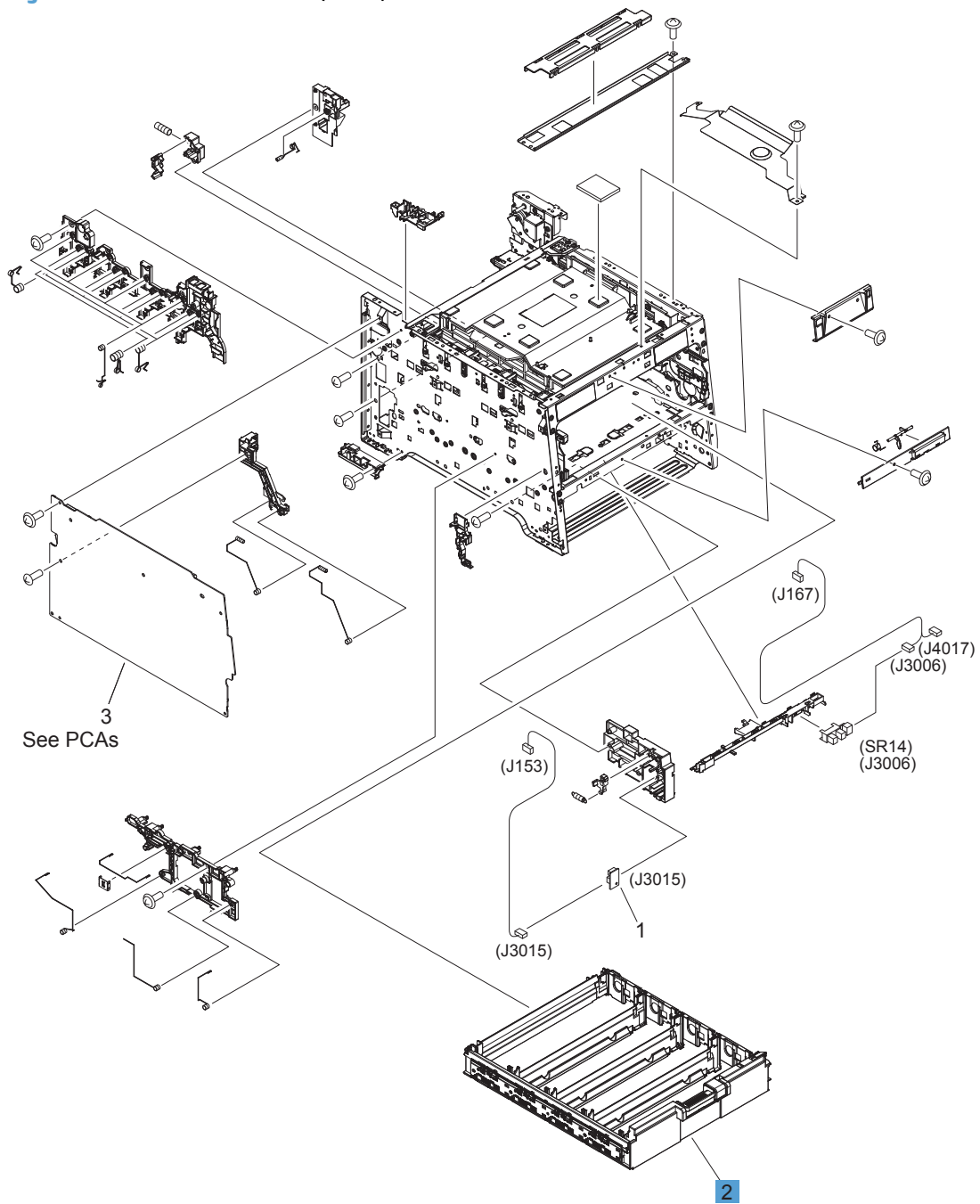


Table 2-11 Internal assemblies (1 of 7)

Ref	Description	Part number	Qty
2	Cartridge-tray assembly	RM2-5299-000	1

Internal assemblies (2 of 7)

Figure 2-4 Internal assemblies (2 of 7)

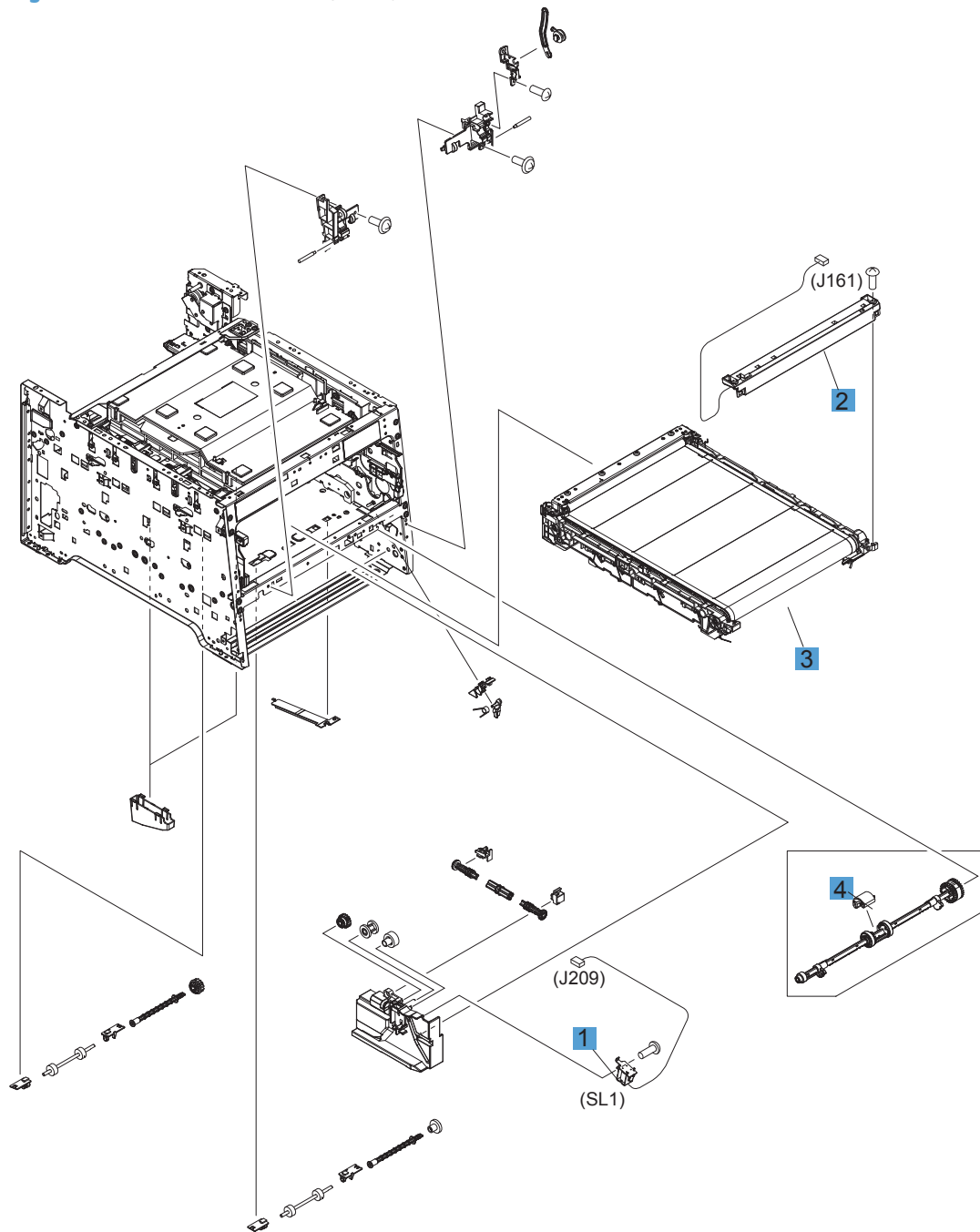


Table 2-12 Internal assemblies (2 of 7)

Ref	Description	Part number	Qty
1	Solenoid, Tray 1 (MP)	RM1-5420-000	1
2	Color misregistration sensor assembly	RM1-8029-000	1
3	Intermediate transfer belt (ITB)	RM2-0192-000	1
4	Roller, paper-pickup Tray 1	RL1-1802-000	1

Internal assemblies (3 of 7)

Figure 2-5 Internal assemblies (3 of 7)

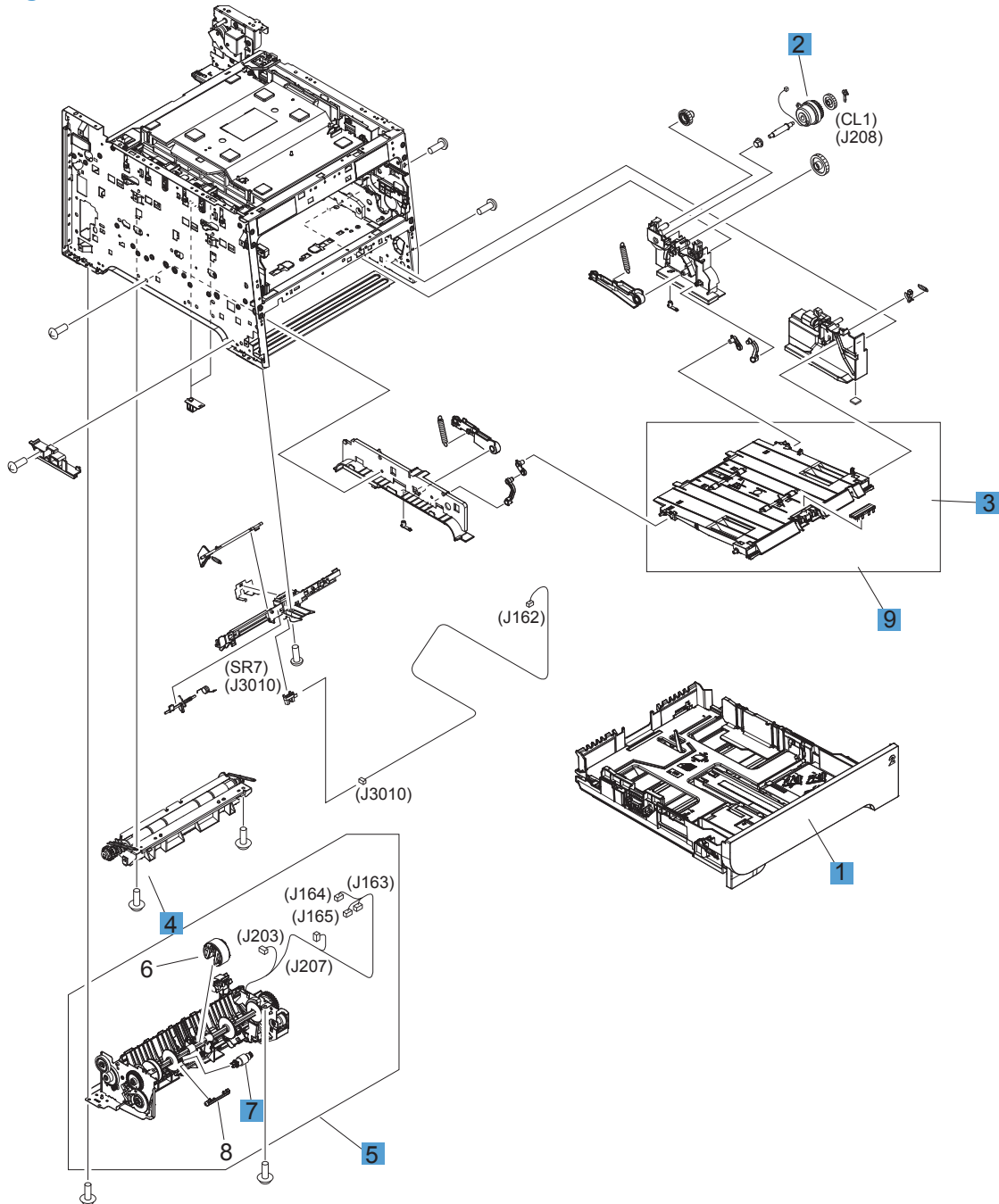


Table 2-13 Internal assemblies (3 of 7)

Ref	Description	Part number	Qty
1	Cassette, Tray 2	RM2-5469-000	1
2	Multi purpose clutch assembly	RM1-8318-000	1
3	Pad, separation Tray 1	RL1-1785-000	1
4	Registration assembly	RM1-4841-000	1
5	Paper pickup assembly	RM1-8045-000	1
6	Tray 2 paper pickup roller assembly	RM1-8047-000	1
7	Tray 2 separation roller assembly	RM1-4840-000	1
9	Multi purpose tray assembly	RM1-8610-000	1

Internal assemblies (4 of 7)

Figure 2-6 Internal assemblies (4 of 7)

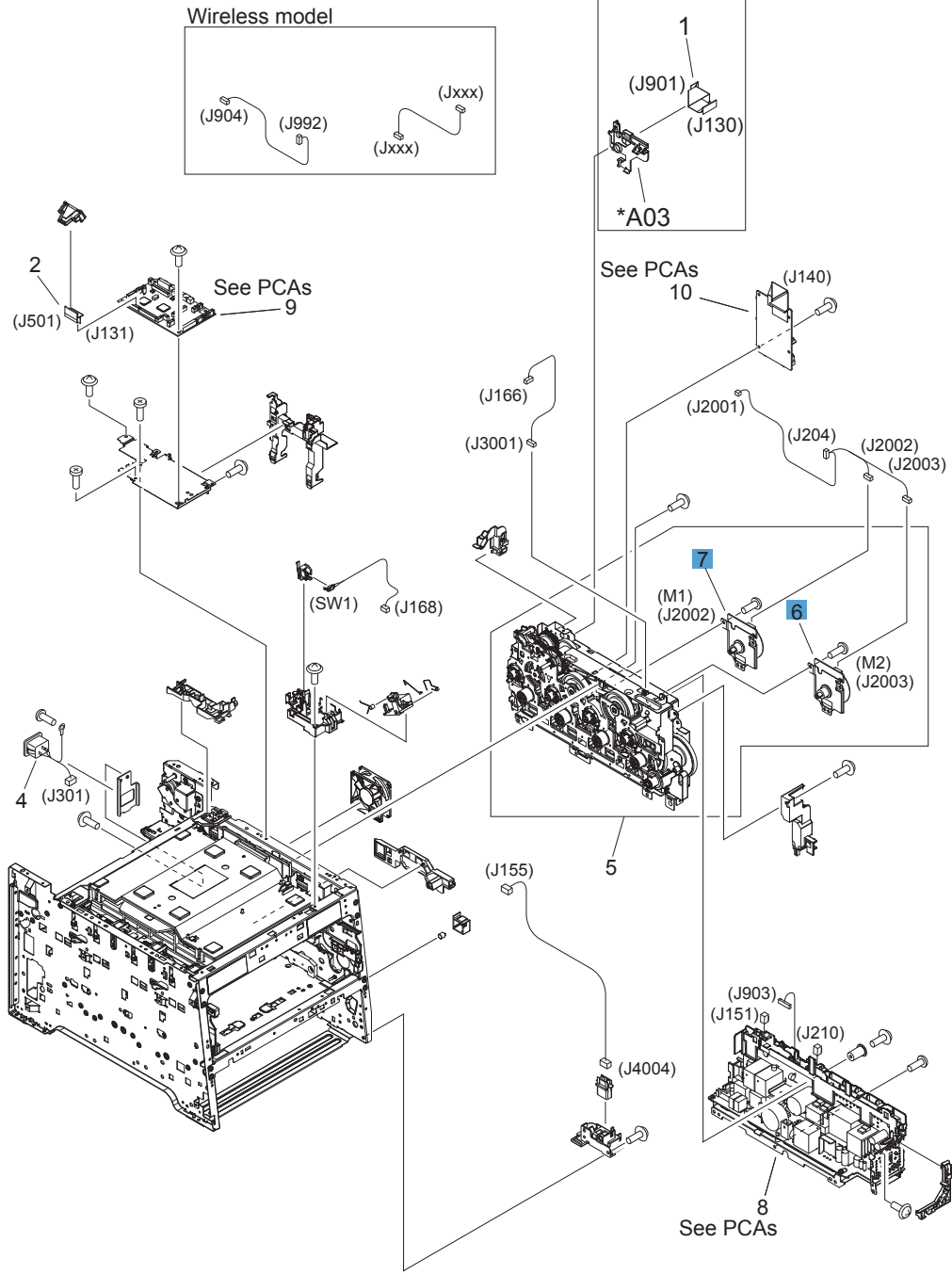


Table 2-14 Internal assemblies (4 of 7)

Ref	Description	Part number	Qty
6	Motor, developer DC (M1)	RL1-3053-000	1
7	Motor, drum DC (M2)	RL1-1800-000	1
8	Fan	RK2-3847-000	1

Internal assemblies (5 of 7)

Figure 2-7 Internal assemblies (5 of 7)

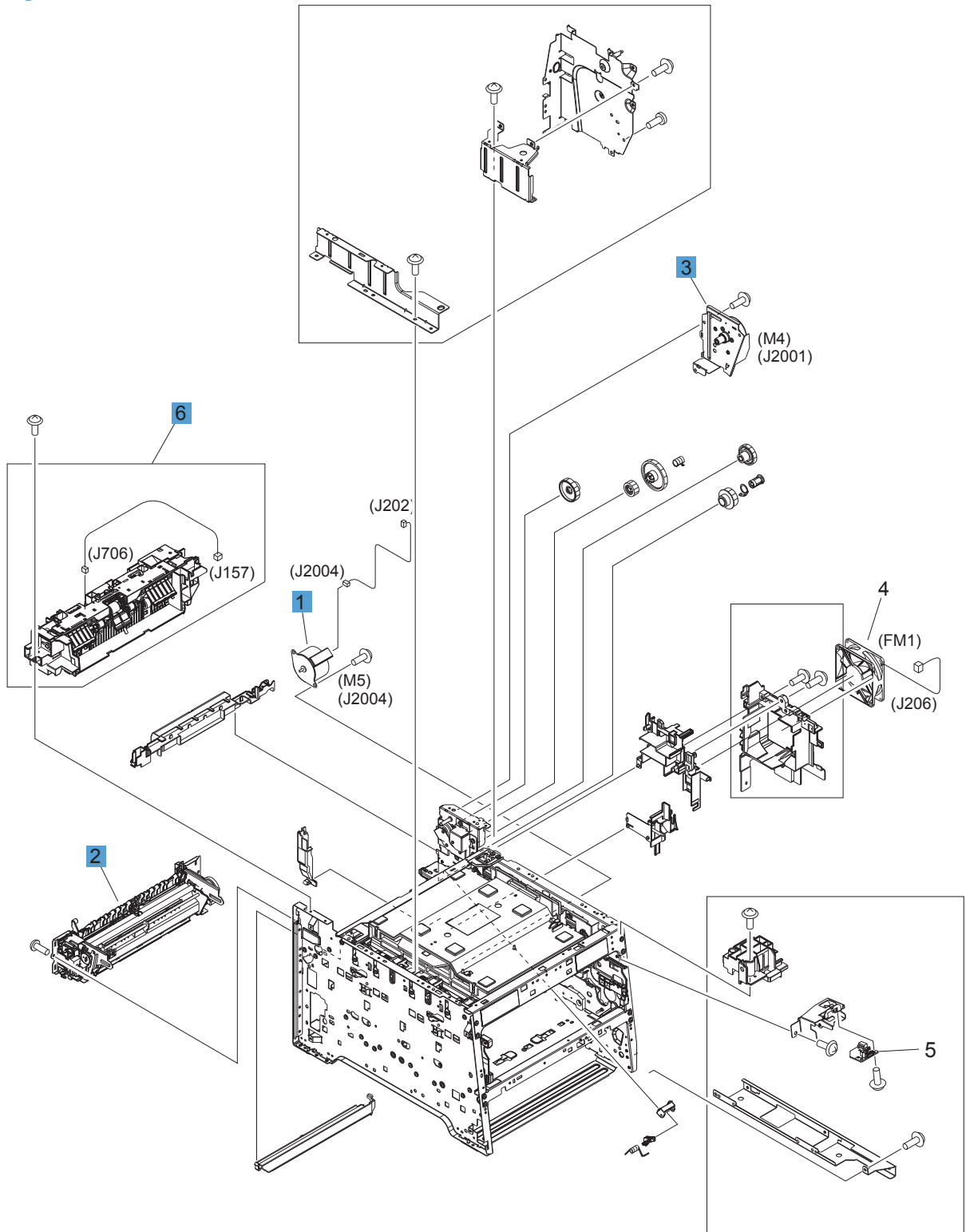


Table 2-15 Internal assemblies (5 of 7)

Ref	Description	Part number	Qty
1	Feed motor assembly	RM1-5419-000	1
2	Fixing assembly (110v)	RM2-5476-000	1
2	Fixing assembly (220v)	RM2-5478-000	1
3	Fixing motor assembly	RM1-8609-000	1
6	Paper delivery assembly	RM1-8049-000	1

Table 2-16 Internal assemblies (6 of 7)

Ref	Description	Part number	Qty
1	Paper feed guide assembly (simplex model; includes transfer roller)	RM1-8043-000	1
2	Door, rear (simplex model)	RC3-1665-000	1
3	Cover, rear (simplex model)	RL1-3072-000	1

Internal assemblies (7 of 7)

Figure 2-9 Internal assemblies (7 of 7)

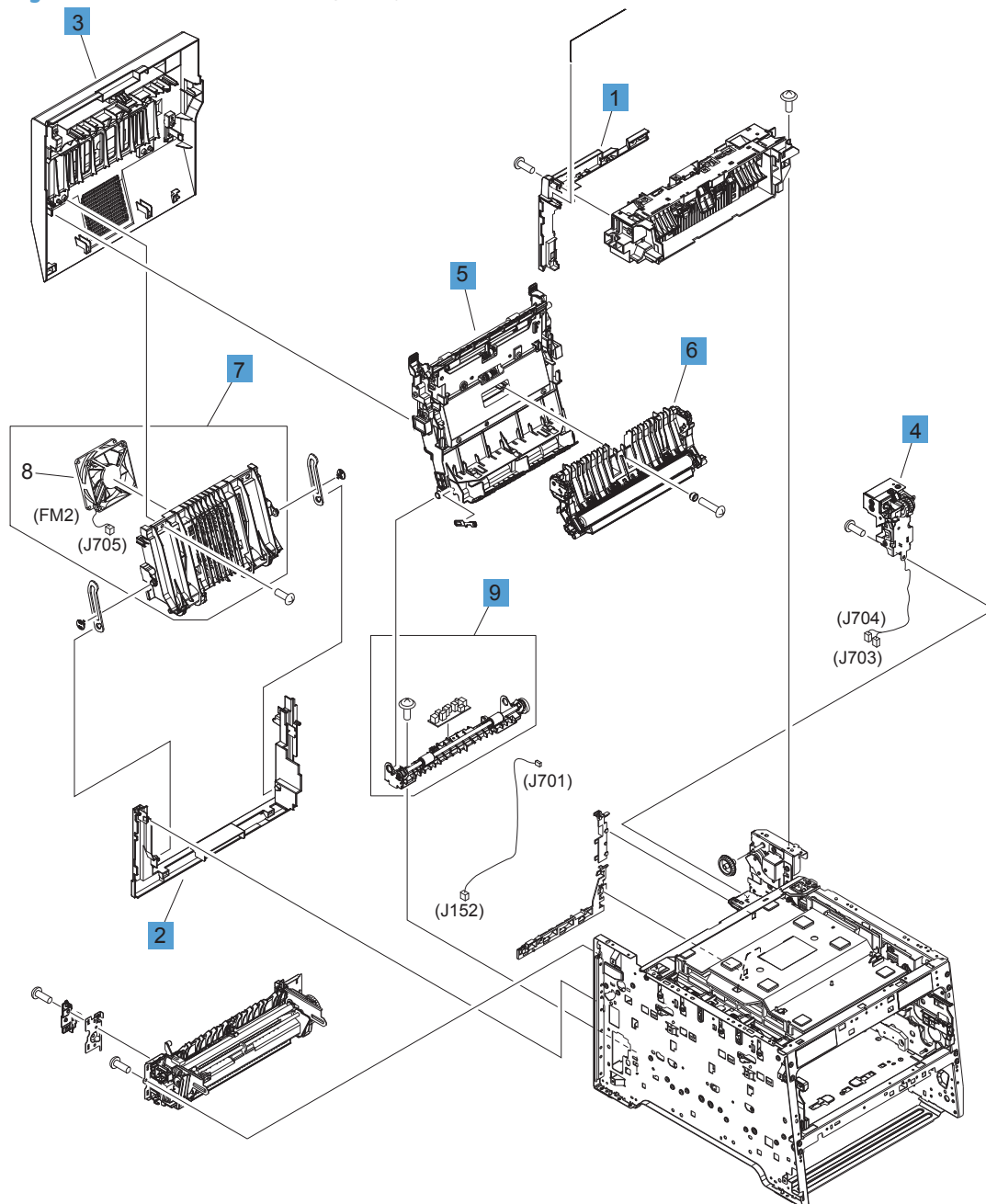


Table 2-17 Internal assemblies (7 of 7)

Ref	Description	Part number	Qty
1	Cover, upper-rear	RL1-3068-000	1
2	Cover, lower-rear	RC3-1700-000	1
3	Door, rear	RM1-8052-000	1
4	Reverse drive assembly	RM1-4880-000	1
5	Feed guide, duplex assembly (includes transfer roller) ¹	RM1-4879-000	1
6	Paper feed guide assembly (includes transfer roller)	RM1-8043-000	1
7	Rib assembly, rear-door	RM1-8053-000	1
9	Paper-pickup guide assembly	RM1-8051-000	1

¹ For a broken link-guide: you must replace either the duplexing-feed guide assembly, or the entire product (the interior paper guide is not replaceable).

PCAs

Figure 2-10 PCAs

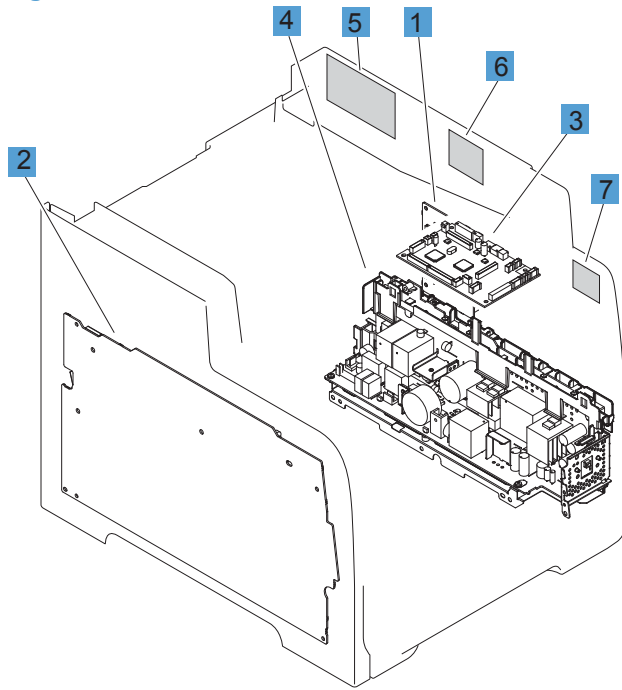


Table 2-18 PCAs

Ref	Description	Part number	Qty
1	Driver PCA	RM1-8032-000	1
2	High-voltage power supply	RM1-8031-000	1
3	DC controller	RM2-8028-000	1
4	Low-voltage power supply (110v)	RM2-8030-000	1
4	Low-voltage power supply (220v)	RM2-8032-000	1
5	Fax PCA (US only)	CF206-60001	1
5	Fax PCA (Europe only)	CF207-60001	1
5	Fax PCA (Brazil only)	CF208-60001	1
6	Wireless controller PCA	1150-7951	1
Not shown	Formatter PCA M476 nw	CF385-60001	1
Not shown	Formatter PCA M476 dn	CF386-60002	1
Not shown	Formatter PCA M476 dw	CF387-60004	1
Not shown	Formatter PCA M476 nw (China only)	CF385-60002	1
Not shown	Formatter PCA M476 dn (China only)	CF386-60003	1
Not shown	Formatter PCA M476 dw (China only)	CF387-60005	1

Accessories

250-sheet paper feeder accessory kit (optional Tray 3)

Figure 2-11 250-sheet paper feeder (optional Tray 3)

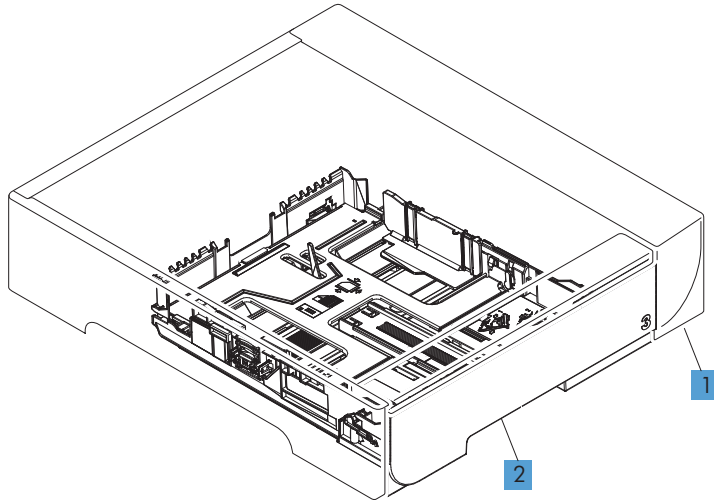


Table 2-19 250-sheet paper feeder accessory kit (optional Tray 3)

Ref	Description	Part number	Qty
1	Tray 3 feeder assembly main body (includes paper cassette)	CE863-67901	1
2	Tray 3 paper cassette only	RM1-8544-000	1

Alphabetical parts list

Table 2-20 Alphabetical parts list

Description	Part number	Table and page
Cartridge-tray assembly	RM2-5299-000	Internal assemblies (1 of 7) on page 119
Cassette, Tray 2	RM2-5469-000	Internal assemblies (3 of 7) on page 123
Color misregistration sensor assembly	RM1-8029-000	Internal assemblies (2 of 7) on page 121
Cover, DIMM	RC4-2852-000	Covers on page 117
Cover, left	RL1-3063-000	Covers on page 117
Cover, lower-rear	RC3-1700-000	Internal assemblies (7 of 7) on page 131
Cover, rear (simplex model)	RL1-3072-000	Internal assemblies (6 of 7) on page 129
Cover, right	RC4-2855-000	Covers on page 117
Cover, right front	RC4-2860-000	Covers on page 117
Cover, top assembly	RM2-5300-000	Covers on page 117
Cover, upper-rear	RL1-3068-000	Internal assemblies (7 of 7) on page 131
DC controller	RM2-8028-000	PCAs on page 133
Door, front assembly	RM2-5301-000	Covers on page 117
Door, rear	RM1-8052-000	Internal assemblies (7 of 7) on page 131
Door, rear (simplex model)	RC3-1665-000	Internal assemblies (6 of 7) on page 129
Driver PCA	RM1-8032-000	PCAs on page 133
Fan	RK2-3847-000	Internal assemblies (4 of 7) on page 125
Fax PCA (Brazil only)	CF208-60001	PCAs on page 133
Fax PCA (Europe only)	CF207-60001	PCAs on page 133
Fax PCA (US only)	CF206-60001	PCAs on page 133
Feed guide, duplex assembly (includes transfer roller) ¹	RM1-4879-000	Internal assemblies (7 of 7) on page 131
Feed motor assembly	RM1-5419-000	Internal assemblies (5 of 7) on page 127
Fixing assembly (110v)	RM2-5476-000	Internal assemblies (5 of 7) on page 127
Fixing assembly (220v)	RM2-5478-000	Internal assemblies (5 of 7) on page 127

Table 2-20 Alphabetical parts list (continued)

Description	Part number	Table and page
Fixing motor assembly	RM1-8609-000	Internal assemblies (5 of 7) on page 127
Formatter PCA M476 dn	CF386-60002	PCAs on page 133
Formatter PCA M476 dn (China only)	CF386-60003	PCAs on page 133
Formatter PCA M476 dw	CF387-60004	PCAs on page 133
Formatter PCA M476 dw (China only)	CF387-60005	PCAs on page 133
Formatter PCA M476 nw	CF385-60001	PCAs on page 133
Formatter PCA M476 nw (China only)	CF385-60002	PCAs on page 133
High-voltage power supply	RM1-8031-000	PCAs on page 133
Intermediate transfer belt (ITB)	RM2-0192-000	Internal assemblies (2 of 7) on page 121
Low-voltage power supply (110v)	RM2-8030-000	PCAs on page 133
Low-voltage power supply (220v)	RM2-8032-000	PCAs on page 133
Motor, developer DC (M1)	RL1-3053-000	Internal assemblies (4 of 7) on page 125
Motor, drum DC (M2)	RL1-1800-000	Internal assemblies (4 of 7) on page 125
Multi purpose clutch assembly	RM1-8318-000	Internal assemblies (3 of 7) on page 123
Multi purpose tray assembly	RM1-8610-000	Internal assemblies (3 of 7) on page 123
Pad, separation Tray 1	RL1-1785-000	Internal assemblies (3 of 7) on page 123
Paper delivery assembly	RM1-8049-000	Internal assemblies (5 of 7) on page 127
Paper feed guide assembly (includes transfer roller)	RM1-8043-000	Internal assemblies (7 of 7) on page 131
Paper feed guide assembly (simplex model; includes transfer roller)	RM1-8043-000	Internal assemblies (6 of 7) on page 129
Paper pickup assembly	RM1-8045-000	Internal assemblies (3 of 7) on page 123
Paper-pickup guide assembly	RM1-8051-000	Internal assemblies (7 of 7) on page 131
Registration assembly	RM1-4841-000	Internal assemblies (3 of 7) on page 123
Reverse drive assembly	RM1-4880-000	Internal assemblies (7 of 7) on page 131
Rib assembly, rear-door	RM1-8053-000	Internal assemblies (7 of 7) on page 131
Roller, paper-pickup Tray 1	RL1-1802-000	Internal assemblies (2 of 7) on page 121

Table 2-20 Alphabetical parts list (continued)

Description	Part number	Table and page
Scanner assembly/ADF	CF387-60106	Scanner and document feeder main assembly on page 115
Solenoid, Tray 1 (MP)	RM1-5420-000	Internal assemblies (2 of 7) on page 121
Tray 2 paper pickup roller assembly	RM1-8047-000	Internal assemblies (3 of 7) on page 123
Tray 2 separation roller assembly	RM1-4840-000	Internal assemblies (3 of 7) on page 123
Tray 3 feeder assembly main body (includes paper cassette)	CE863-67901	250-sheet paper feeder accessory kit (optional Tray 3) on page 135
Tray 3 paper cassette only	RM1-8544-000	250-sheet paper feeder accessory kit (optional Tray 3) on page 135
Wireless controller PCA	1150-7951	PCAs on page 133

Numerical parts list

Table 2-21 Numerical parts list

Part number	Description	Table and page
1150-7951	Wireless controller PCA	PCAs on page 133
CE863-67901	Tray 3 feeder assembly main body (includes paper cassette)	250-sheet paper feeder accessory kit (optional Tray 3) on page 135
CF206-60001	Fax PCA (US only)	PCAs on page 133
CF207-60001	Fax PCA (Europe only)	PCAs on page 133
CF208-60001	Fax PCA (Brazil only)	PCAs on page 133
CF385-60001	Formatter PCA M476 nw	PCAs on page 133
CF385-60002	Formatter PCA M476 nw (China only)	PCAs on page 133
CF386-60002	Formatter PCA M476 dn	PCAs on page 133
CF386-60003	Formatter PCA M476 dn (China only)	PCAs on page 133
CF387-60004	Formatter PCA M476 dw	PCAs on page 133
CF387-60005	Formatter PCA M476 dw (China only)	PCAs on page 133
CF387-60106	Scanner assembly/ADF	Scanner and document feeder main assembly on page 115
RC3-1665-000	Door, rear (simplex model)	Internal assemblies (6 of 7) on page 129
RC3-1700-000	Cover, lower-rear	Internal assemblies (7 of 7) on page 131
RC4-2852-000	Cover, DIMM	Covers on page 117
RC4-2855-000	Cover, right	Covers on page 117
RC4-2860-000	Cover, right front	Covers on page 117
RK2-3847-000	Fan	Internal assemblies (4 of 7) on page 125
RL1-1785-000	Pad, separation Tray 1	Internal assemblies (3 of 7) on page 123
RL1-1800-000	Motor, drum DC (M2)	Internal assemblies (4 of 7) on page 125
RL1-1802-000	Roller, paper-pickup Tray 1	Internal assemblies (2 of 7) on page 121
RL1-3053-000	Motor, developer DC (M1)	Internal assemblies (4 of 7) on page 125
RL1-3063-000	Cover, left	Covers on page 117
RL1-3068-000	Cover, upper-rear	Internal assemblies (7 of 7) on page 131
RL1-3072-000	Cover, rear (simplex model)	Internal assemblies (6 of 7) on page 129

Table 2-21 Numerical parts list (continued)

Part number	Description	Table and page
RM1-4840-000	Tray 2 separation roller assembly	Internal assemblies (3 of 7) on page 123
RM1-4841-000	Registration assembly	Internal assemblies (3 of 7) on page 123
RM1-4879-000	Feed guide, duplex assembly (includes transfer roller) ¹	Internal assemblies (7 of 7) on page 131
RM1-4880-000	Reverse drive assembly	Internal assemblies (7 of 7) on page 131
RM1-5419-000	Feed motor assembly	Internal assemblies (5 of 7) on page 127
RM1-5420-000	Solenoid, Tray 1 (MP)	Internal assemblies (2 of 7) on page 121
RM1-8029-000	Color misregistration sensor assembly	Internal assemblies (2 of 7) on page 121
RM1-8031-000	High-voltage power supply	PCAs on page 133
RM1-8032-000	Driver PCA	PCAs on page 133
RM1-8043-000	Paper feed guide assembly (simplex model; includes transfer roller)	Internal assemblies (6 of 7) on page 129
RM1-8043-000	Paper feed guide assembly (includes transfer roller)	Internal assemblies (7 of 7) on page 131
RM1-8045-000	Paper pickup assembly	Internal assemblies (3 of 7) on page 123
RM1-8047-000	Tray 2 paper pickup roller assembly	Internal assemblies (3 of 7) on page 123
RM1-8049-000	Paper delivery assembly	Internal assemblies (5 of 7) on page 127
RM1-8051-000	Paper-pickup guide assembly	Internal assemblies (7 of 7) on page 131
RM1-8052-000	Door, rear	Internal assemblies (7 of 7) on page 131
RM1-8053-000	Rib assembly, rear-door	Internal assemblies (7 of 7) on page 131
RM1-8318-000	Multi purpose clutch assembly	Internal assemblies (3 of 7) on page 123
RM1-8544-000	Tray 3 paper cassette only	250-sheet paper feeder accessory kit (optional Tray 3) on page 135
RM1-8609-000	Fixing motor assembly	Internal assemblies (5 of 7) on page 127
RM1-8610-000	Multi purpose tray assembly	Internal assemblies (3 of 7) on page 123
RM2-0192-000	Intermediate transfer belt (ITB)	Internal assemblies (2 of 7) on page 121

Table 2-21 Numerical parts list (continued)

Part number	Description	Table and page
RM2-5299-000	Cartridge-tray assembly	Internal assemblies (1 of 7) on page 119
RM2-5300-000	Cover, top assembly	Covers on page 117
RM2-5301-000	Door, front assembly	Covers on page 117
RM2-5469-000	Cassette, Tray 2	Internal assemblies (3 of 7) on page 123
RM2-5476-000	Fixing assembly (110v)	Internal assemblies (5 of 7) on page 127
RM2-5478-000	Fixing assembly (220v)	Internal assemblies (5 of 7) on page 127
RM2-8028-000	DC controller	PCAs on page 133
RM2-8030-000	Low-voltage power supply (110v)	PCAs on page 133
RM2-8032-000	Low-voltage power supply (220v)	PCAs on page 133

Index

A

- accessories
 - ordering 108
 - part numbers 109
- after service checklist 6

C

- cautions iii
- checklists
 - after service 6
 - preservice 6
- control panel
 - reinstalling 40
 - removing the control panel 39
- conventions, document iii
- copy-quality test 7
- covers
 - left, removing 45
 - locations 116
 - parts list 116
 - right, removing 25
 - upper, removing 42

D

- DC controller PCA, removing 69
- diagrams 107
 - covers 116
 - internal assemblies 118
- document conventions iii
- document feeder
 - document feeder, scanner, removing 18
 - removing 18
- document feeder pickup roller
 - removing 13
- doors
 - front, removing 48

E

- electrostatic discharge (ESD) 2
- ESD (electrostatic discharge) 2

F

- fax PCA, removing 65
- fax troubleshooting
 - fax-quality test 7
- fax-quality test 7
- formatter PCA, removing 65
- front door, removing 48

I

- internal assemblies
 - parts list 118
- internal assembly
 - locations 118

L

- left cover, removing 45

N

- notes iii

O

- ordering
 - product documents 111

P

- parts 107
 - 2ndary service 4
 - cover locations 116
 - customer self repair 109
 - internal assembly locations 118
 - numbers 111
 - ordering 108
 - screws 5
 - service 111
 - using lists and diagrams 112
 - whole unit replacement 110

- pickup roller
 - removing 9
- pliers, required 3
- post-service tests 7
- preservice checklist 6
- print-quality test 7
- Pro 400 Color MFP M476 dn
 - whole unit replacement 110
- Pro 400 Color MFP M476 dw
 - whole unit replacement 110
- Pro 400 Color MFP M476 nw
 - whole unit replacement 110

R

- reinstalling parts
 - control panel 40
 - DC controller PCA 69
- removing parts
 - cautions for 2
 - checklists 6
 - control panel 39
 - DC controller PCA 69
 - document feeder 18
 - document feeder pickup roller 13
 - fax PCA 65
 - formatter PCA 65
 - front door 48
 - left cover 45
 - pickup roller 9
 - right cover 25
 - rollers 8
 - separation roller 11
 - tools, required 3
 - upper cover 42
- replacing
 - parts 2
- right cover, removing 25

- rollers
 - pickup and separation,
removing 8
- rollers and pads
 - removing 8

S

- scanner
 - assembly, removing 17
- screwdrivers, required 3
- screws
 - replacing 2
- separation roller, removing 11
- service
 - tools, required 3
- static precautions 2
- supplies
 - ordering 108
 - part numbers 109

T

- tests
 - copy-quality 7
 - fax-quality 7
 - post-service 7
 - print-quality 7
- tips iii
- toner cartridges
 - part numbers 109
- tools, required 3
- Tray 3
 - part number 109

U

- upper cover, removing 42
- USB cable, part number 109

W

- warnings iii
- whole unit replacement 110

